

2021
**COMMERCIAL
AIR SOLUTIONS**

LG AIR SOLUTION



2021

COMMERCIAL AIR SOLUTIONS



Distributed by

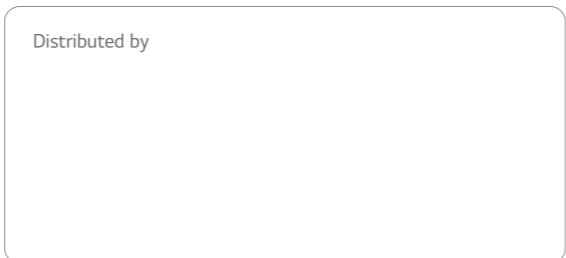

LG Electronics

<http://www.lg.com>
<http://partner.lge.com>

028

OUTDOOR UNITS

MULTI V 5	030
MULTI V S	060
MULTI V M	082
MULTI V WATER IV (HEAT PUMP / HEAT RECOVERY)	092

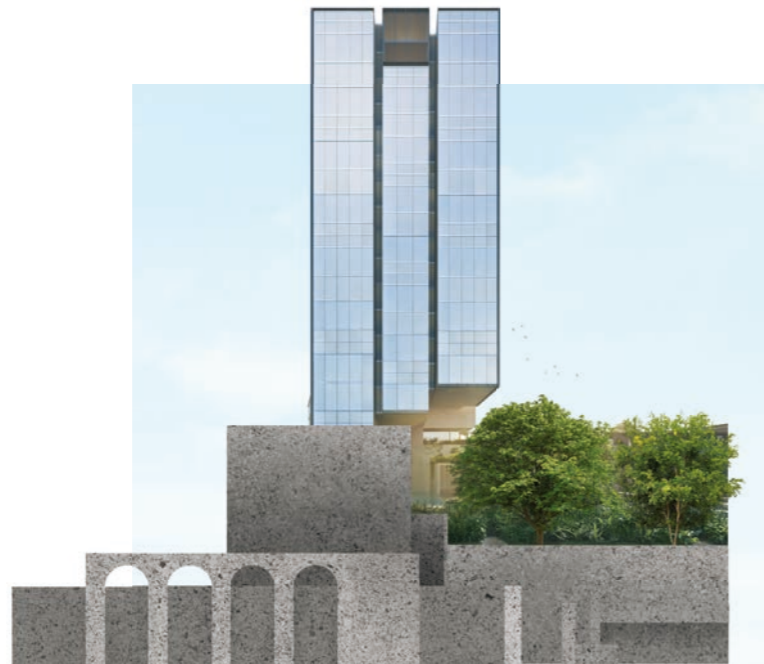

118

INDOOR UNITS

WALL MOUNTED	120
CEILING MOUNTED CASSETTE	134
CEILING MOUNTED ROUND CASSETTE	152
CEILING CONCEALED DUCT	156
FRESH AIR INTAKE	172
CEILING & FLOOR CONVERTIBLE CEILING SUSPENDED	174
CONSOLE & FLOOR STANDING	180
COMPATIBILITY & FEATURE FUNCTIONS	188



192

HOT WATER SOLUTION

HYDRO KIT	194
-----------	-----



202

VENTILATION SOLUTIONS

ERV	204
ERV WITH DX COIL	212

214

CHILLER

INVERTER SCROLL CHILLER	218
FCU	230

244

CONTROL SOLUTIONS

INDIVIDUAL CONTROL	250
CENTRALIZED CONTROL	262
INTEGRATION DEVICE	282

318

ACCESSORIES

MECHANICAL ACCESSORIES	320
PIPING ACCESSORIES	328

NEW INNOVATION FOR 2021

MULTI V™ News

ULTIMATE EFFICIENCY • R32 • AIR PURIFYING • MATCHING DESIGN

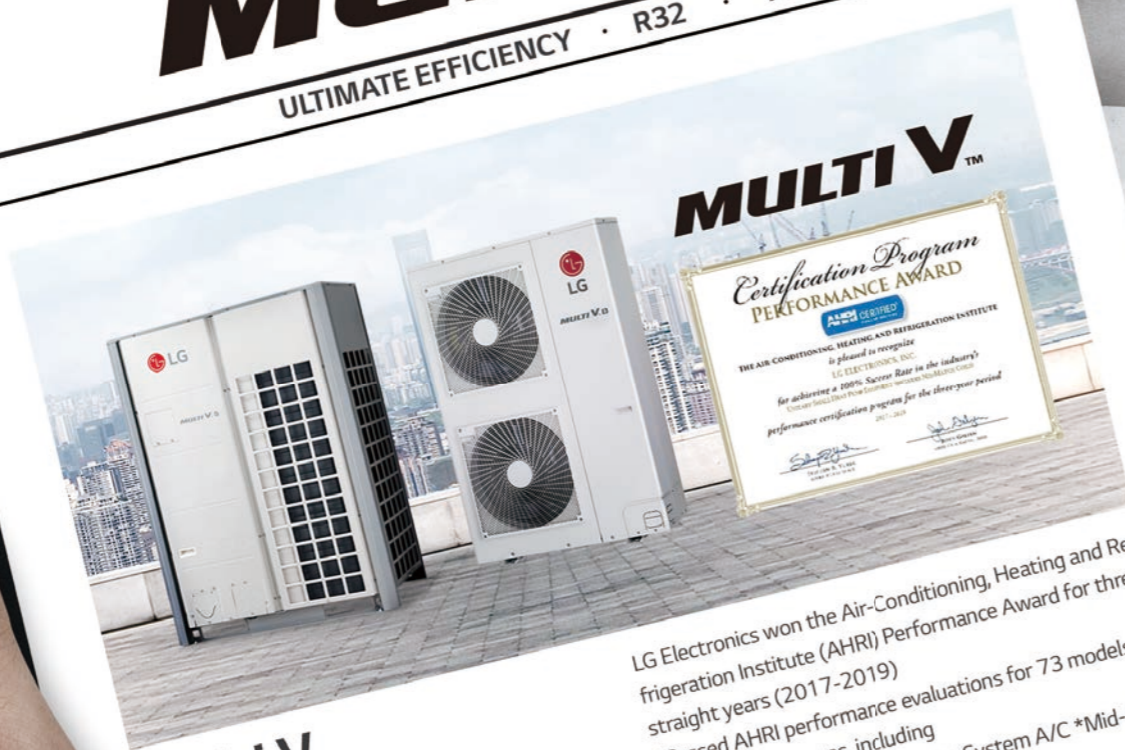

**Multi V,
Recognized for
its technology
and Innovativeness**

LG Electronics won the Air-Conditioning, Heating and Refrigeration Institute (AHRI) Performance Award for three straight years (2017-2019)
*Passed AHRI performance evaluations for 73 models in 7 main product groups, including
*Integrated A/C *Large-capacity System A/C *Mid- to Small-capacity System A/C



**Air Cleaning Function
for the post-COVID era**

LG System Air Conditioners provide air purification suited for COVID-19 era, and even global brands like Starbucks choose it for their needs. 4-Steps Air Purifying Process Removes Invisibility



**Eco-conscious refrigerant
with the future in mind**

New line-up applying the industry-first mini VRF with R32 refrigerant to MULTI V S.

- Air cooled VRF Heat pump
- 12.1 - 15.5kW (Cooling capacity based)
- Both 1Ø, 220 - 240V, 50Hz and 3Ø, 380 - 415V, 50Hz
- Side discharge outdoor unit



LG participates in the ECP programme for EUROVENT VRF program. Check ongoing validity of certification
: www.eurovent-certification.com

**New Innovation
Novel Design**



ADVANTAGE OF **MULTI V**



DUAL SENSING CONTROL

ULTIMATE EFFICIENCY

Ultimate Energy Saving with Dual Sensing Control.



Humidity + Temperature

Ultimate Efficiency

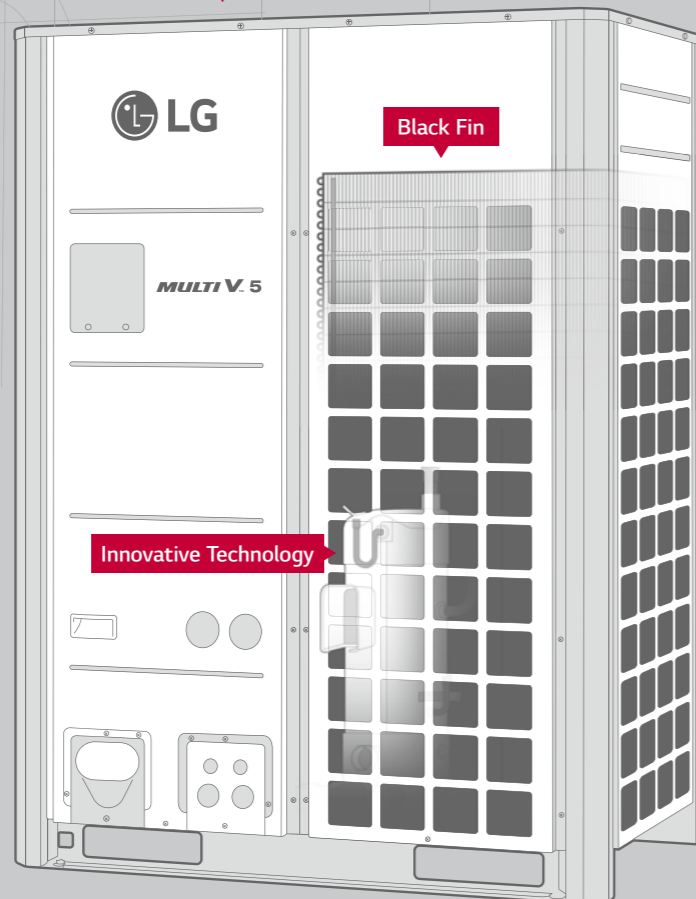

Black Fin

SUPERIOR DURABILITY

LG's exclusive "Black Fin" heat exchanger is designed to perform even in corrosive Environments.

Certified protection

※ Verification of corrosion resistance performance
- Declared by TUV Rheinland
- Test Method B of ISO21207
- Test condition : Salt contaminated condition + severe industrial / traffic environment (NO2 / SO2)



Gebze, Turkey

Riyadh, Saudi Arabia

Noida, India

Changwon & Pyeongtaek, Korea

Tianjin, China

Qingdao, China

Haiphong, Vietnam

Pune, India

Rayong, Thailand

BRAND RELIABILITY

Global production sites facilitate world-class customer service.



R32 APPLICATION

New line-up applying the industry-first mini VRF with R32 refrigerant to MULTI V S.

DIVERSE PRODUCT LINE UP

Integrated solution optimized for various business environments, including hot water, AHU, BMS, and EMS.

SMART CONTROLS

MULTI V responds to diverse building environments with LG ThinQ-based AI control and individual / central integrated control solutions.



R1 Compressor™

INNOVATIVE TECHNOLOGIES

Ultimate Inverter Compressor
- MULTI V 5
Revolutionary Scroll R1 Compressor
- MULTI V S R32, MULTI V M

DESIGN FLEXIBILITY

Flexible Installation with Large Capacity Outdoor Unit.
MULTI V 5 enables easy type change-over to suit the purpose of any building. MULTI V S allows versatile design with flexible piping locations.

MULTI V BRAND HISTORY

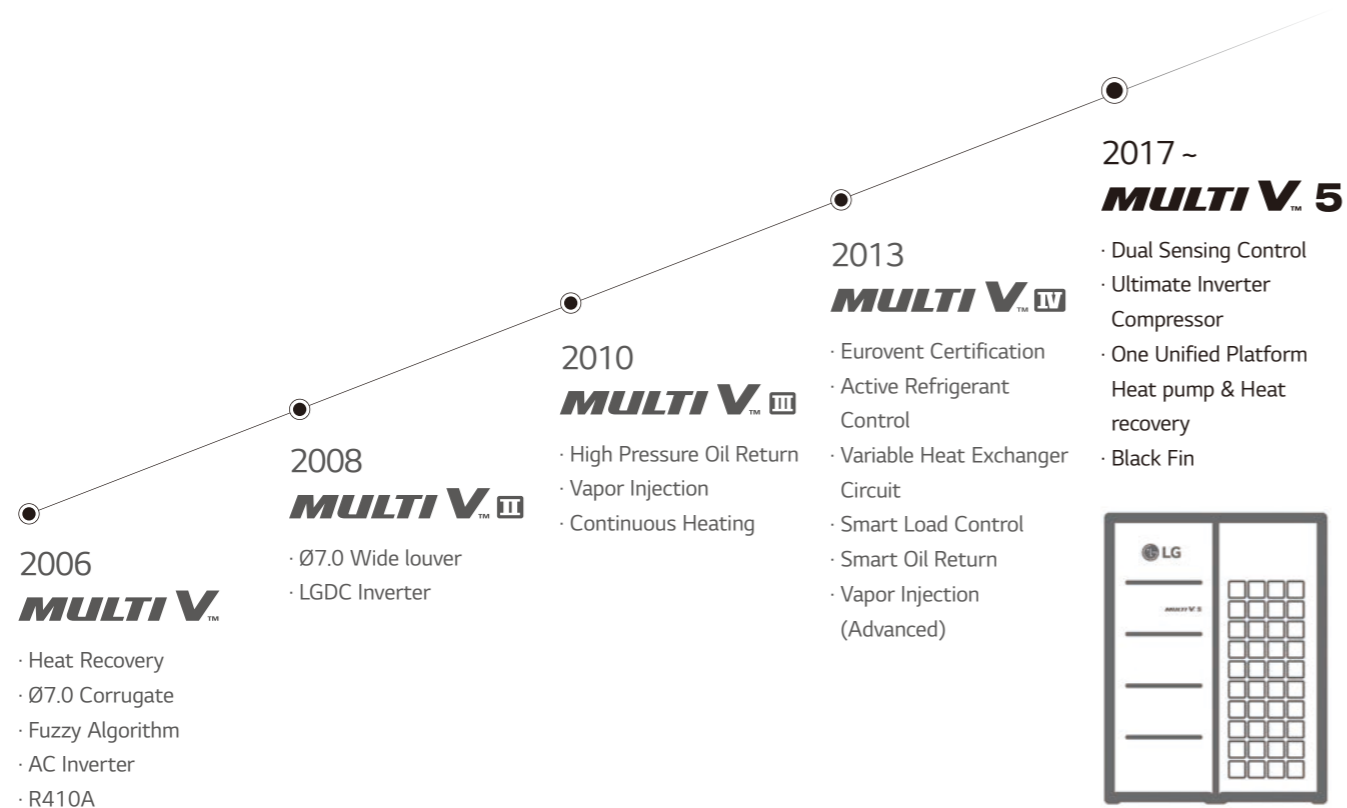

Since the time when LG launched Korea's first residential air conditioner in 1968, the company has worked to continuously enhance its technological innovation and reliability. As a result of sustained improvement, LG VRF launched the first generation of MULTI V in 2006 and achieved significant development. With the best-in-class compressor technology and innovation applied to every part and control solution, MULTI V has evolved to be one of the world's most efficient and reliable VRF solutions.

The first and second generations of MULTI V boasted inverter technology and non-ozone depleting technology, while MULTI V III was produced with cutting edge tech like oil return with HiPOR™ and double compression features with mid-pressure refrigerant allowed by Vapor Injection. The innovative technologies of MULTI V's fourth generation brought about product leadership in efficiency. Its smart load control adjusts with the outdoor temperature, while optimizing refrigeration management and heat exchange for both cooling and heating.

MULTI V's wide range of VRF solutions satisfies various building types and sizes. MULTI V S's size discharge was designed for small to mid-sized buildings while MULTI V Water is a water-cooled VRF solution with variable water flow control technology.

In 2017, the ultimate VRF solution was introduced with MULTI V 5. This generation has fully improved its technological potential with the powerful and reliable yet economical Ultimate Inverter Compressor, effective corrosion resistance with the Black Fin coating and enlarged fans. Dual Sensing Control offers the most pleasant indoor environment while minimizing unnecessary energy loss by sensing both temperature and humidity to efficiently manage cooling, heating and part load.

MULTI V 5 has been designed for the ultimate efficiency, performance, flexibility, comfort and control, ensuring the most pleasant indoor experience.

INFRASTRUCTURE IN EUROPE





LG Air Conditioning Academy

LG has set up 20 official air conditioning academies in Europe, teaching much needed skills to thousands of current industry professionals including installers, consultants, designers, sales staff and service technicians. The academy program is being used to share expertise and educate these HVAC experts by providing a cutting-edge technical experience with the newest and most advanced technologies and equipment. Moreover, as LG's entire product range is installed on site, professionals can be trained in a realistic way that offers them the chance to experience the latest products first-hand.



European Air Conditioning Distribution Center

LG's European Air Conditioning Distribution Center is located in Oosterhout, the Netherlands. Supplying and delivering products all over Europe, this distribution hub has contributed to smooth and rapid delivery, direct shipping for smaller orders and delivery tailored to air conditioners. The hub tries to manage inventory efficiency by taking advantage of LG EU's established inventory pool.

-  Air Conditioning Academy
-  Europe Energy Lab
-  European Distribution Center



ENGINEERING TOOLS & SUPPORT

From planning to service & maintenance and then to de-construction, an architectural project goes through many stages from the beginning to the end of its lifecycle. Along those stages, various engineering tools are applied to solve the diverse issues happening in each stage, with the most optimal solution possible. Given the usage of such tools, buildings are effectively designed, built, supervised, and maintained throughout their lifecycle.

Dedicated to provide the best HVAC engineering support, LG Electronics Air Solution Business Unit offers several engineering tools and solutions focused on HVAC, during the overall lifecycle of a building, related to the three categories. Among them, the LATS* Program series has been developed to offer the best tool for LG HVAC systems, providing our customers with a solution that allows for faster, easier and more accurate model selection, draft energy estimations and more.

* LATS : LG Air-conditioner Technical Solution



I

**Energy Estimation
& Energy Modeling**



II

**Model Selection
& Design**



III

**Installation
Environment
Simulation**

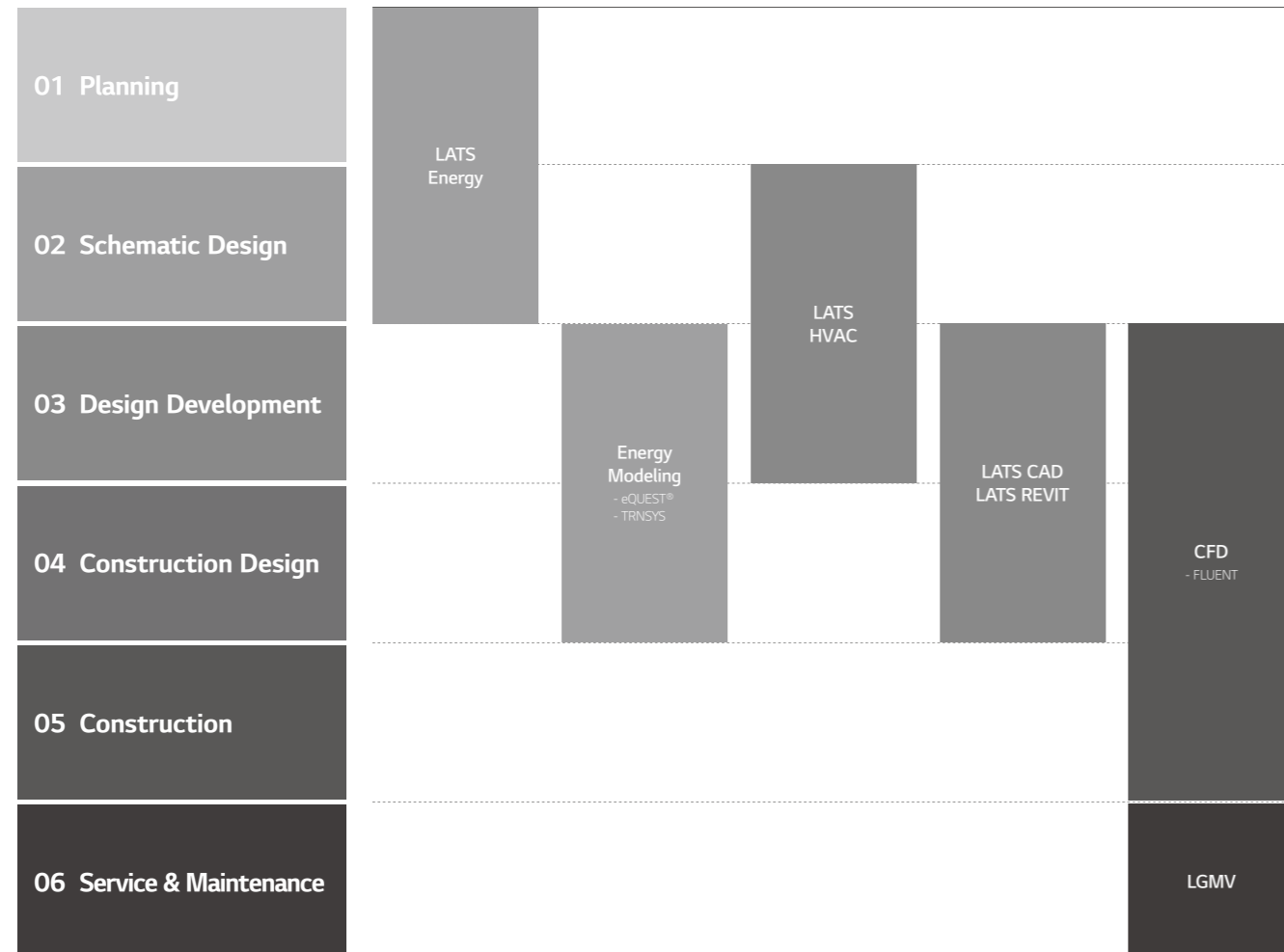

01 Draft Energy Estimation

LATS Energy

LATS Energy is a program developed by LG to estimate energy consumption and analyze the life cycle cost of LG commercial air conditioning systems during a project's early stages.



02 Building Energy Modeling

eQuest, EnergyPro, Trace700 and More

These are certified commercial programs which assess the HVAC system efficiency and building's annual energy savings for building standards or certifications, like LEED. LG HQ supports these programs for the project stages of Design Development and Construction Design wherein the overall designing is finished.

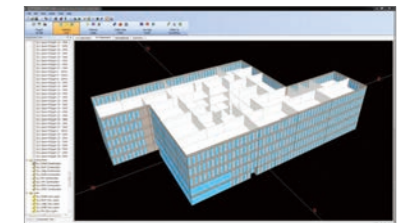

03 Model Selection

LATS HVAC

LATS HVAC is a model selection program that accurately and quickly selects the most suitable LG commercial air conditioning systems for each design. In addition to model selection, faster estimation on refrigerant piping diameter and additional refrigerant is possible, along with auto printing of reports.

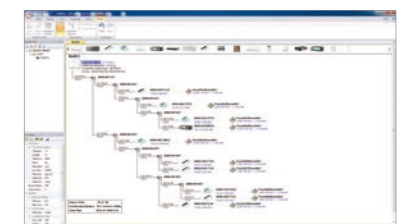

04 Design

LATS CAD

LATS CAD enables faster and more accurate 2D design of LG commercial air conditioning systems. It also enables modules for quotation and installation review that minimize inherent problems during installation and commissioning.

※ AutoCAD program is required.



LATS REVIT

LATS REVIT allows BIM users to have an attractive 3D design of LG commercial air conditioning systems with embedded calculations for refrigerant and efficiency features.

※ AutoCAD Revit program is required.

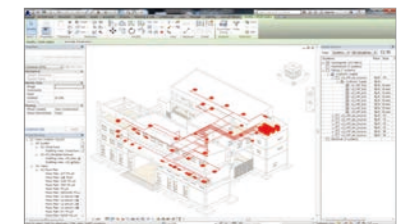

05 Environment Simulation

CFD Analysis

CFD Analysis is applied in areas of estimating : indoor airflow and temperature distribution while operating VRF products, outdoor airflow distribution, and noise level. By running a simulation before construction, engineers estimate possible issues and find optimal solutions for malfunctions that could occur after construction.

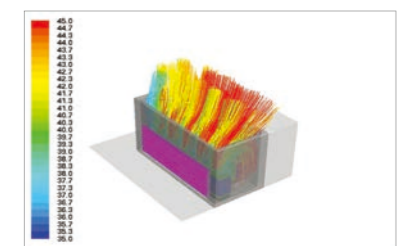

06 Service & Maintenance

LGMV

LGMV offers real-time MULTI V cycle monitoring. During start-up, LGMV can check for normal operation as well as troubleshoot any errors. Also it helps to find causes of errors and solve the problem faster.



BENEFITS OF LG MULTI V

Benefits for Building Owners



Efficient Management & Cost Reduction

- Fault Detection Diagnosis enables easy maintenance
- Requires no extra manpower for regular maintenance
- With diverse control systems, maintenance cost is minimized



Reliability at Every Stage

- Ultimate Inverter Compressor developed and manufactured in Korea
- Corrosion resistant Black Fin for harsh conditions operation
- Smart Oil management (Auto Oil Balancing and Active Oil return) decreases compressor damage



Customized Comfort and Solution

- Compatible option between Heat pump and Heat recovery system is possible



Benefits for Developers & Construction Companies



Green Solutions

- Optimized for LEED/BREEAM certification
- Renewable energy solution provided through geothermal application



Maximizing Space Utilization

- Large capacity in compact size enhances space utilization



Smart Building Solutions

- Seamless integration with current Building Management Systems
- Wi-Fi control available for anytime, anywhere access (via the 'LG ThinQ' mobile app)
- Energy management and control according to usage and planning is possible with LG's centralized control solution



Benefits for Consultants



Versatile Solutions

- Air-cooled, Water-cooled, Heating, and Air Handling Unit interlocking solutions



Professional Design Support

- LATS (LG Air-conditioner Technical Solution) for draft energy estimation, model selection, HVAC design and 3D designing
- CFD Analysis to ensure suitable solutions and prevent malfunctions
- Energy simulation offered to find the optimal solution



Optimized Convenience with HVAC Design

- Flexible and longer piping length facilitates HVAC designing process
- Meets any type of customer requirements of diverse environment, design conditions, and building applications



Benefits for End-users



Cost Saving Operation

- High efficiency guaranteed throughout product line-up
- Up to 31% cost savings with MULTI V's Smart Load Control*



Comfort Cooling & Heating

- Smart Load Control maximizes indoor comfort level
- Dual Sensing Control offers pleasant and comfortable cooling and heating environment
- Duration time of Continuous Heating is 11% longer than previous model**



Convenient Functions

- Low-noise operation provides a pleasant environment

* Dual Smart Load Control ESEER based, below 50% humidity, model ARUM260LTE5
** LG internal test result



APPLICATION SOLUTIONS

Office

Supporting efficiency with flexibility

High Rise Office Building

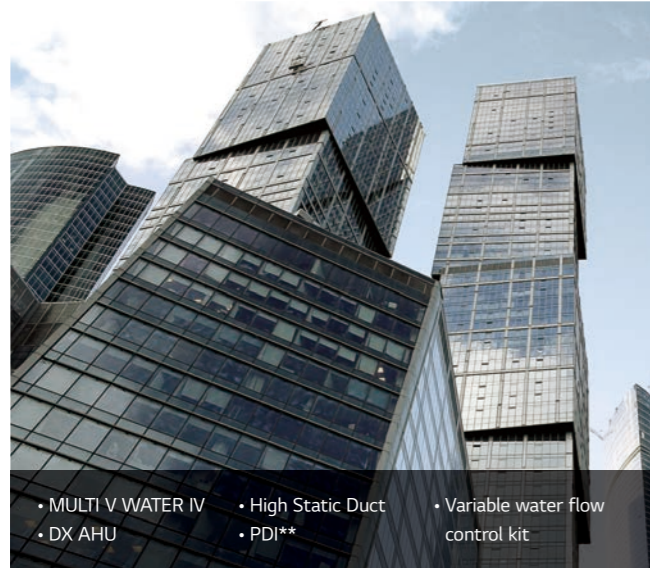

- MULTI V WATER IV
- DX AHU
- High Static Duct
- PDI**
- Variable water flow control kit

Small to Medium sized Office Building



- MULTI V 5 / S
- 4 Way CST*
- PDI**

The MULTI V series revitalizes the workspace by providing fresh air at all times. LG's intelligent control solutions add comfort to any space.

Commercial

Maximizing business, minimizing cost

Shopping Mall



- MULTI V 5
- DX AHU

Retail



- MULTI V M
- ERV
- Convertible

Quick Service Restaurant (QSR)



- MULTI V M
- ERV
- Hydro Kit
- 4 Way CST

The highly efficient, energy saving MULTI V 5 and MULTI V M reduces operation costs, and provides comfort that suits any purpose and any space, helping to invest the extra space and expense to your business.

* CST : Cassette ** PDI : Power Distribution Indicator

Residential

Creating a comfortable home

Condominium & Apartments

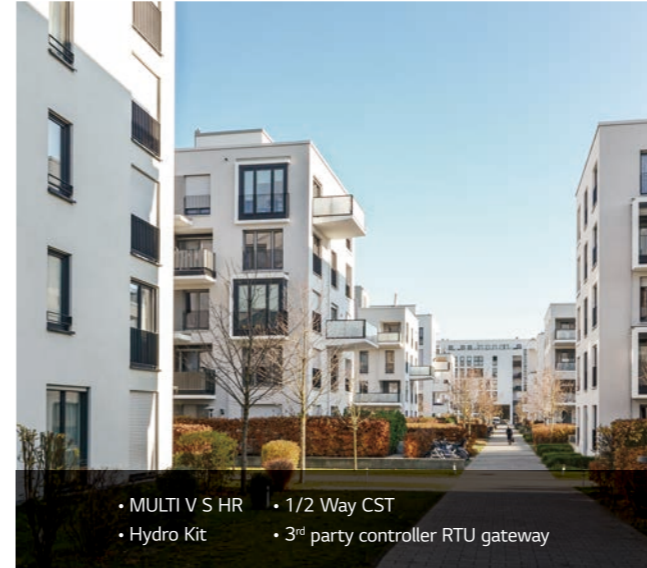

- MULTI V S HR
- Hydro Kit
- 1/2 Way CST
- 3rd party controller RTU gateway

Single Family House & Villa



- MULTI V S
- Therma V
- ESS* & PV** Solar

Remarkably compact size and high static pressure of MULTI V S enables optimal space solution, providing comfort to every space through individual zone control and hot water solution.

Hospitality

Meeting diverse needs

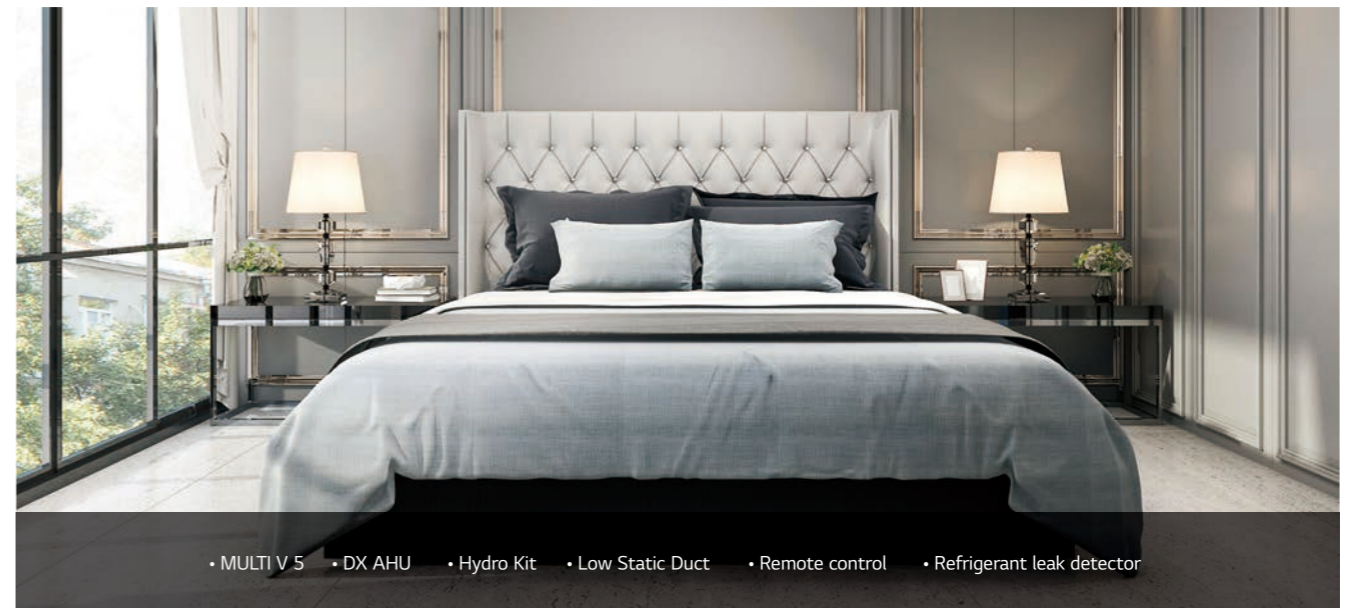

- MULTI V 5
- DX AHU
- Hydro Kit
- Low Static Duct
- Remote control
- Refrigerant leak detector

The diverse applications that can be applied to MULTI V 5 helps bring just the right solution to a sophisticated hotel business.

* ESS : Energy Storage System ** PV : Photovoltaics

Hot Water Solution

Water heating costs can be reduced with a heat pump, which provides higher efficiency than a boiler system. The Hydro Kit can be connected to Multi V 5, providing temperatures up to 80C. Energy savings can be maximized with the combination of the Hydro Kit and the Multi V 5 Heat Recovery system.

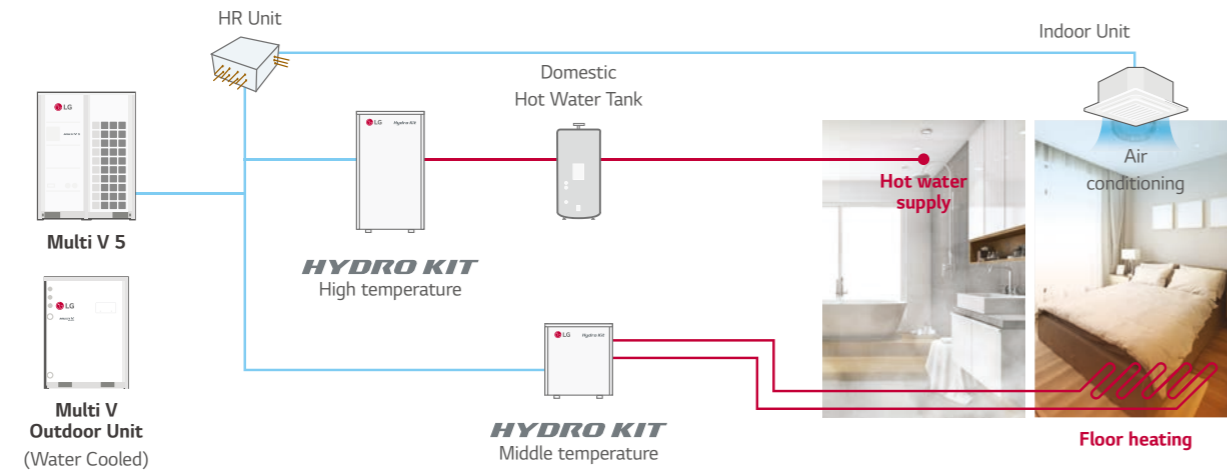

Air Handling Unit (AHU) Solution

AHU is a suitable solution for cooling and heating in large space. With an LG AHU Comm. Kit (for both return air / supply air control) connected to the DX coil of the AHU, LG VRF system can be applied to deliver conditioned air.

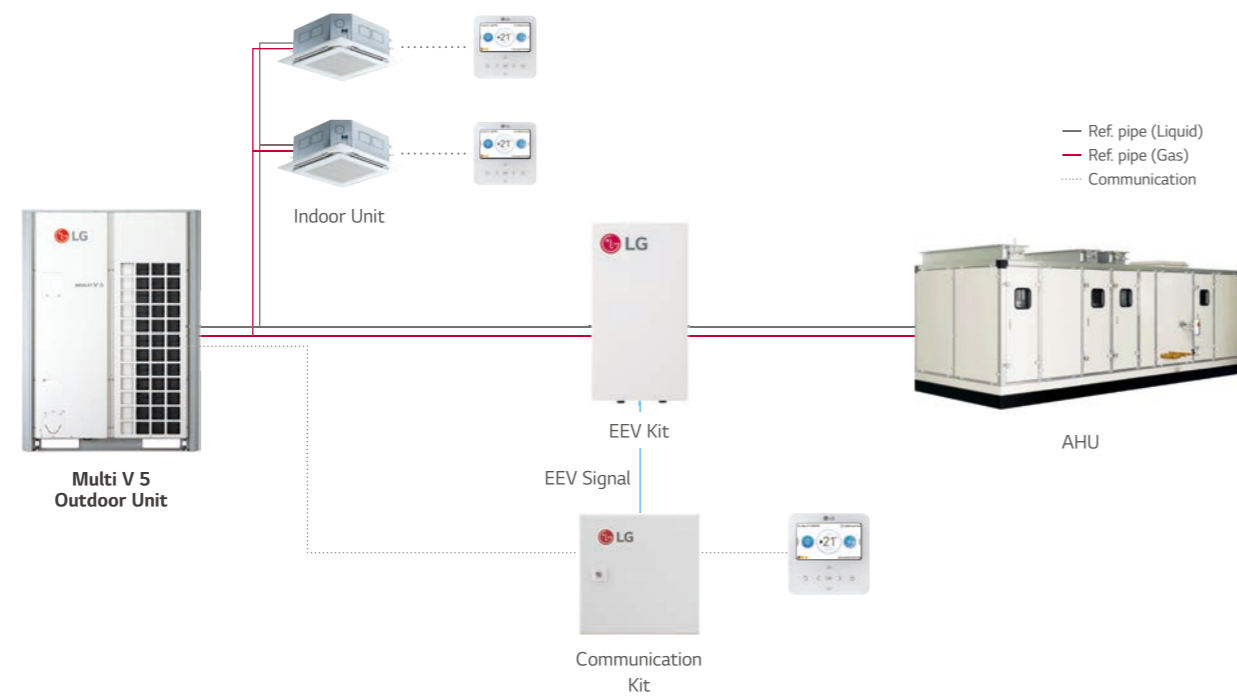

Refrigerant Leak Detection Solution

Real-time refrigerant leak detection ensures a safe environment. When refrigerant concentration exceeds 6,000ppm for 5 seconds, the indoor unit will stop operation and alert users with a buzzer or light switch (Dry contact option).

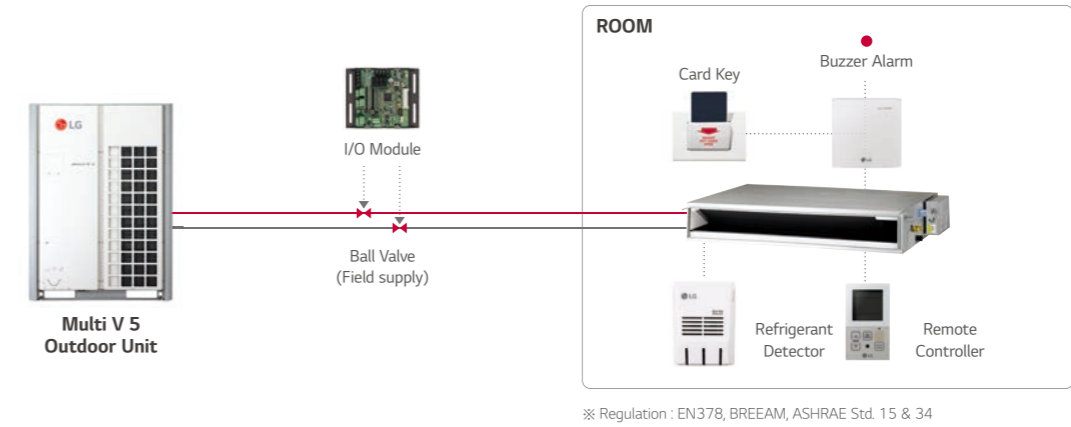

Power Consumption Distribution Solution

In case of shared power consumption in a building, a solution to distribute the power consumption amount per tenant might be necessary. Electricity charges can be billed to each tenant by using output from the LG Power Distributor Indicator (PDI). An administrator is able to check the power usage for each space and date as needed. If the PDI is used in conjunction with an LG central controller, the results can be exported to Excel.

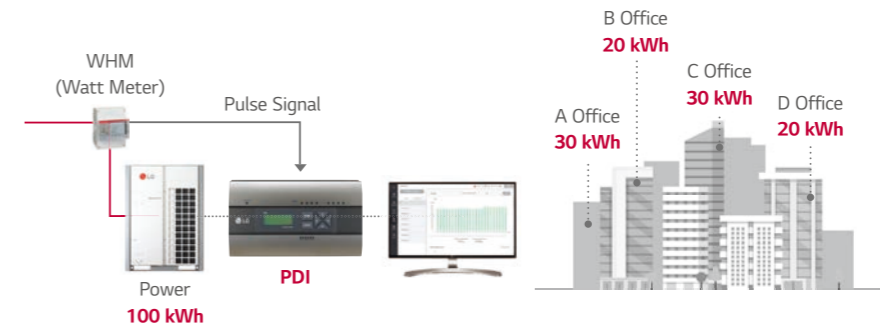

Total Control of Any Device

In order to manage multiple spaces and multiple buildings, the administrators should be able to control systems from wherever they are. The LG central controller can be controlled from any web browser that supports HTML5. Now through the implementation of HTML5, the interface will look great and perform well on any device.



Energy Management Solution

Since HVAC systems use a significant portion of any building's total amount of energy, the energy saving functions of a controller can make a big difference. The energy navigation function enables you to set target values for energy consumption over a certain period of time. In addition, to achieve that value, the administrator can set the energy saving logic in 7 steps and predict the expected usage relative to the target value. Active self-management enables energy savings throughout the building.



Interlocking Solution by Using ACU Module

It is costly to introduce a BMS system to control multiple devices or systems in a small building. With the ACU module, various IO contact points (DI, DO, UI, AO) can be interlocked and integrated, while control is possible from the LG central controller. This enables an efficient management of lighting, pumps and other devices in the building in conjunction with the HVAC system.

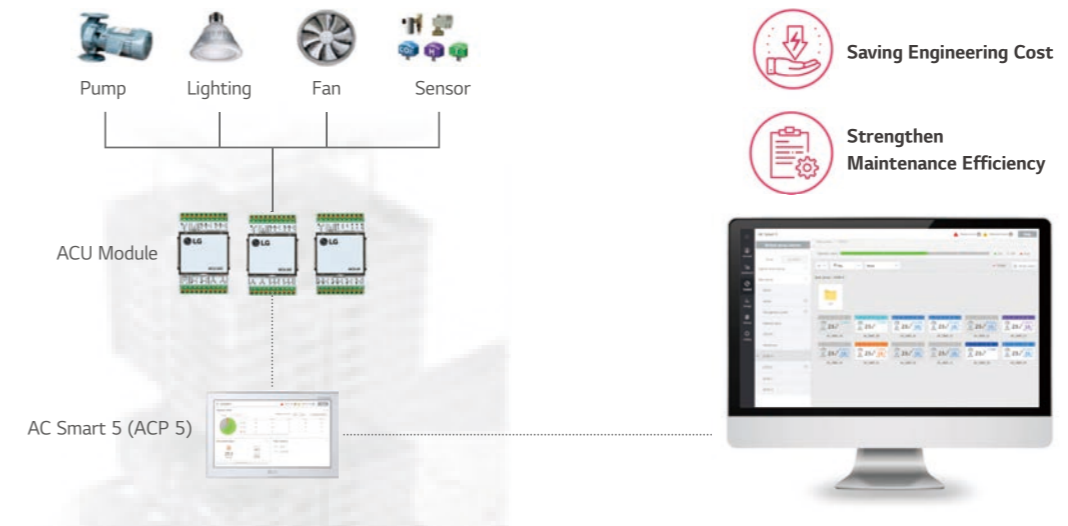

Integration Solution with BMS

There are many BMS protocols used for the control of buildings' various systems such as HVAC, lighting, power and security. LG has a wide range of gateway products for different protocols such as BACnet, Modbus, and LonWorks. In addition, LG gateways include Stand-alone central control capability to act as a back-up controller of the BMS if needed.

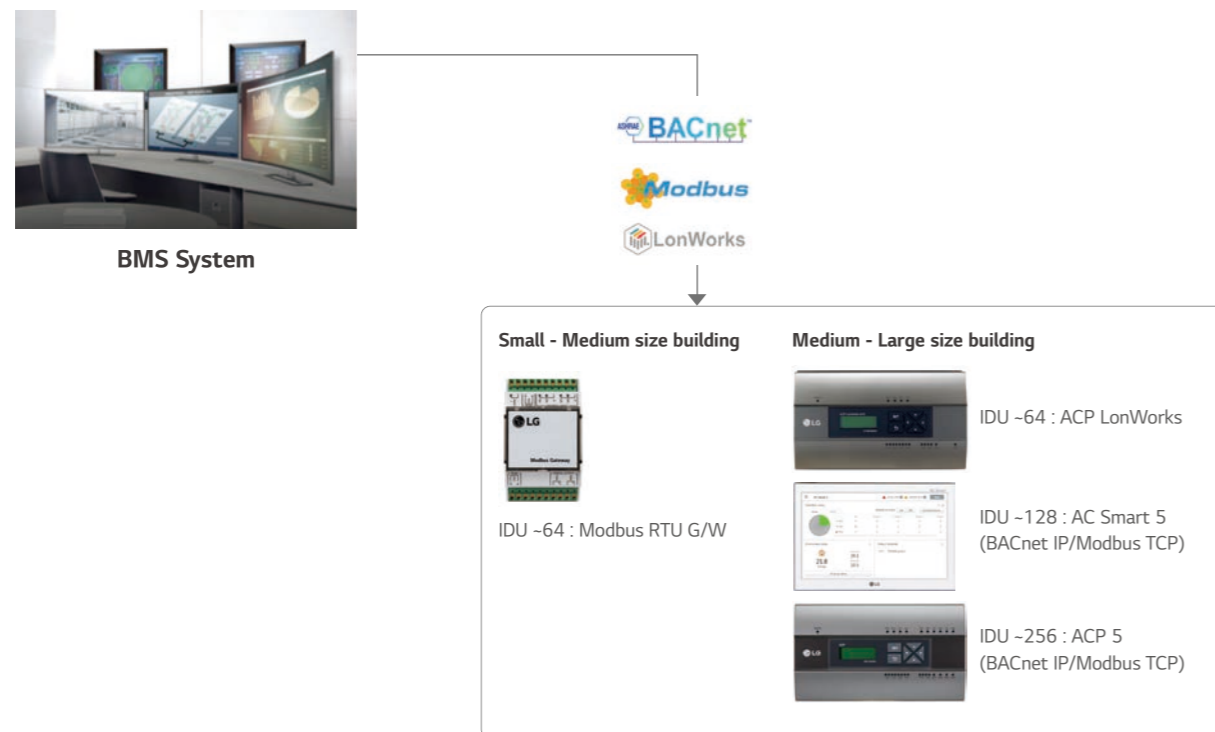

Interlocking Solution Using Dry Contact

3rd party thermostats can be used to control LG air conditioners in a room by using a multi point dry contact. The dry contact enables basic control of air conditioners as well as making it possible to report the status and any errors impacting the indoor unit. The Standard III remote control has a DO port. With this DO port, it is possible to interlock the indoor unit with 3rd party devices such as lighting, a fan, or a radiator, based on things like operation mode or current temperature. The indoor unit can be interlocked with various types of input such as card key-tag, door sensor, human detection sensor etc. so that the air conditioner is automatically operated. In addition, the dry contact option settings enable operation of air conditioner to maintain proper temperature when the occupant is absent. This solution makes sure that the room does not overheat or become too cold when unoccupied so that energy cost can be saved.



OUTDOOR UNITS LINE-UP

MULTI V™ 5

8 - 12 HP
380V, 3Ø

14 - 26 HP
380V, 3Ø

22 - 48 HP
380V, 3Ø



50 - 72 HP
380V, 3Ø

74 - 96 HP
380V, 3Ø



MULTI V™ M

5 HP
380V, 3Ø

MULTI V™ S

4 - 5 HP
220V, 1Ø

4 - 6 HP
380V, 3Ø / 220V, 1Ø

8 - 12 HP
380V, 3Ø

6 HP
220V, 1Ø

Heat Recovery

4 - 6 HP
220V, 1Ø
380V, 3Ø

R32

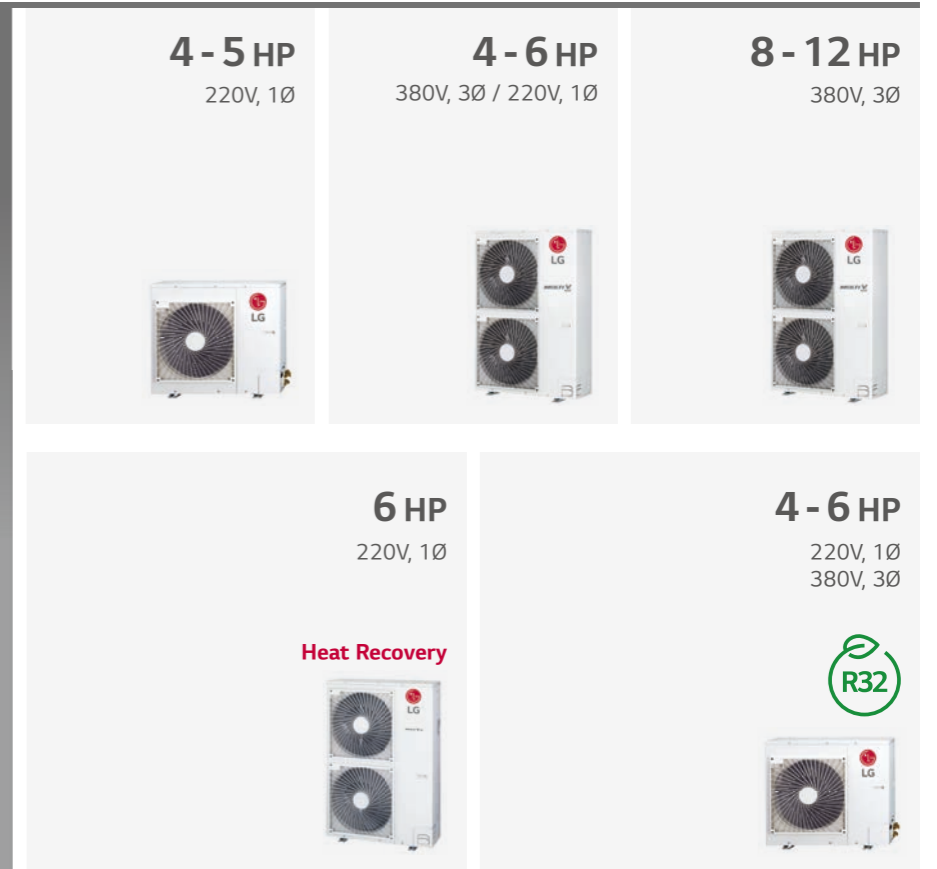

MULTI V™ WATER IV

8 - 10, 14, 20 HP
380V, 3Ø

16 - 18, 22 - 24, 28 - 30, 34, 40 HP
380V, 3Ø



















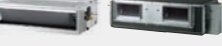



42 - 44, 48 - 50, 54, 60 HP
380V, 3Ø

62 - 64, 68 - 70, 74, 80 HP
380V, 3Ø

OUTDOOR UNITS LINE-UP

Features	Appearance	4	5	6	8	10	12	14	16	18	20	22	24	26	28	30	32	34	36	38	40	42	44	46	48	50	52	54	56	58	60	62	64	66	68	70	72	74	76	78	80	...	96										
<p>MULTI VTM 5</p> <ul style="list-style-type: none"> Dual Sensing Control Large capacity ODU (Up to 26HP) Continuous Heating Black Fin heat exchanger Heat pump / heat recovery Flexible installation (Heat recovery unit & large capacity) Large space, Individual control building <p>Shopping mall Education Airport</p>					●	●	●																																														
								●	●	●	●		●	●	●																																						
														●	●	●	●	●	●	●	●	●	●	●	●	●	●																										
																												●	●	●	●	●	●	●	●	●	●	●	●	●	●	●											
																																													●	●	●	●	●				
<p>MULTI VTM S</p> <ul style="list-style-type: none"> Space saving Flexible design Slim, light, broad range (4 -12 HP) Large number of connectable indoor units (Up to 20 Units) Small, Medium building <p>Apartment House & villa</p>		○	○																																																		
		●	○	○	○	●	●	●																																													
					○																																																
		○	○	○	○																																																
<p>MULTI VTM M</p> <ul style="list-style-type: none"> High flexibility of installation Various indoor unit combinations & long distance between modules Retail shop <p>Office Cafe Restaurant</p>				●																																																	
<p>MULTI VTM WATER IV</p> <p>HEAT PUMP / HEAT RECOVERY</p> <ul style="list-style-type: none"> High efficiency systems Indoor installation Low noise operation (No fan) Simultaneous cooling & heating Individual control building, Large building <p>Hospital Resort</p>					●	●		●			●																																										
									●	●				●	●		●																																				
																							●	●		●	●		●																								
																																																		●	●	●	●

kW		1.5	2.2	2.8	3.6	4.5	5.6	6.2	7.1	8.2	9.0	10.6	12.3	14.1	15.8	22.4	28.0		Energy Monitoring	2 Set Point	Occupied / Unoccupied Scheduling Function	Group Control	Test Run (Cooling)	Test Run (Heating)	Model Information Monitoring	Auto Addressing	Refrigerant Leakage Detection	Thermo On / Off Range Setting (Cooling)	Thermo On / Off Range Setting (Heating)	Static Pressure 11 Step Control (Only for Ceiling Concealed Duct Type)	1 Point External Input (On / Off Control)	Filter Sign (Remaining Time)	Auto Restart Function Disable / Enable	Wi-Fi Ready
		5k	7k	9k	12k	15k	18k	21k	24k	28k	30k	36k	42k	48k	54k	76k	96k																	
4 th generation Wall Mounted	Artcool Gallery 		●	●	●														●	●	●	●	●	●	●	●	●	●		●	●	●	●	
	Artcool Mirror 	●	●	●	●	●	●	●											●	●	●	●	●	●	●	●	●	●		●	●	●	●	
	Standard 	●	●	●	●	●	●	●	●			●	●						●	●	●	●	●	●	●	●	●	●		●	●	●	●	
4 th generation Ceiling Mounted Cassette	4 Way Cassette (570 x 570) 	●	●	●	●	●	●	●											●	●	●	●	●	●	●	●	●	●		●	●	●	●	
	4 Way Cassette (840 x 840) 								●	●	●	●	●	●					●	●	●	●	●	●	●	●	●	●		●	●	●	●	
	4 Way Cassette High Sensible (840 x 840) 		●	●	●	●	●	●	●	●		●	●	●					●	●	●	●	●	●	●	●	●	●		●	●	●	●	
	Round Ceiling Cassette 								●			●		●					●	●	●	●	●	●	●	●	●	●		●	●	●	●	
	2 Way Cassette 			●	●		●		●											●	●	●	●	●	●	●	●	●	●		●	●	●	●
	1 Way Cassette 		●	●	●		●		●											●	●	●	●	●	●	●	●	●	●		●	●	●	●
4 th generation Ceiling Concealed Duct	Mid / High Statics 		●	●	●	●	●		●	●		●	●	●	●	●	●		●	●	●	●	●	●	●	●	●	●	●		●	●	●	●
	Low (Slim) / Low Statics 	●	●	●	●	●	●	●	●										●	●	●	●	●	●	●	●	●	●	●		●	●	●	●
	High Sensible 		●	●	●	●	●		●	●		●	●	●					●	●	●	●	●	●	●	●	●	●	●		●	●	●	●
4 th generation Fresh Air Intake 																●	●		●	●	●	●	●	●	●	●	●	●		●	●	●	●	
4 th generation Ceiling & Floor Convertible 			●	●															●	●	●	●	●	●	●	●	●	●		●	●	●	●	
4 th generation Ceiling Suspended 							●		●			●		●					●	●	●	●	●	●	●	●	●	●		●	●	●	●	
4 th generation Console 			●	●	●	●													●	●	●	●	●	●	●	●	●	●		●	●	●	●	
4 th generation Floor Standing	Floor Standing with Case 		●	●	●	●	●		●										●	●	●	●	●	●	●	●	●	●		●	●	●	●	
	Floor Standing without Case 		●	●	●	●	●		●										●	●	●	●	●	●	●	●	●	●		●	●	●	●	
4 th generation HYDRO KIT	Wall-Mounted 	●	●	●																														
	Low Temperature 												●					●		●	●	●	●	●	●	●	●	●		●	●	●	●	
	High Temperature 													●			●		●	●	●	●	●	●	●	●	●	●		●	●	●	●	
4 th generation Energy Recovery Ventilator with DX Coil	with Humidifier 					●			●		●								●	●	●		●	●		●	●		●	●	●	●		
	without Humidifier 					●			●		●								●	●	●		●	●		●	●		●	●	●	●		

※ If 4th generation indoor units are combined to 2nd generation indoor units, several functions are not available.
More detailed information, refer to the "MULTI V Indoor units Compatibility Table"

Individual Control			Centralized Control		
Wired Remote Controller		Wireless Remote Controller	Display	Platform	Gateway
Standard	Simple				
Standard III (White)		PWLSSB21H (Heat Pump) PWLSSB21C (Cooling Only)	AC Ez	ACP 5	ACP LonWorks
PREMTB100	PQRCVCLQW		PQCSZ250S0 (Indoor Unit - 32)	PACP5A000 (Indoor Unit - 256) BACnet IP / Modbus TCP	PLNWKB000 (Indoor Unit - 64)
Standard III (Black)		Wi-Fi Modem	AC Ez Touch	AC Manager 5	Modbus RTU gateway
PREMTBB10	PQRCVCLQ	For Indoor Unit PWFMD200	PACEZA000 (Indoor Unit - 64)	PACM5A000 (Indoor Unit - 8,192)	PMBUSB00A (Indoor Unit - 64)
Standard II (White)		AC Smart 5	PI485	PI485	PI485
PREMTB001	PQRCHCAQW (Simple for Hotel)				
Standard II (Black)		AC Smart 5	PI485	PI485	PI485
PREMTBB01	PQRCHCAQ (Simple for Hotel)				
Premium					
PREMTA000 PREMTA000A PREMTA000B					

Centralized Control	Integration Device			
Facility Integrator	Indoor Unit		Outdoor Unit	AHU Kit
	Dry Contact	Control Accessory		
PDI (Power Distribution Indicator)	Group Control Wire	IO Module (Input / Output Module)	Communication Kit	
Premium (8 ports) PQNUD1S40 Standard (2 ports) PPWRDB000	PZCWRG3	For MULTI V IV, 5 PVDSMN000	Return / Room Air Control PAHCMR000	
ACS IO Module (Input / Output Module)	Remote Temperature Sensor	Variable Water Flow Control Kit		
PEXPMB000	PQRSTA0	For MULTI V WATER IV PWFCKN000	Discharge / Supply Air Control PAHCS000	
Chiller Option Kit	Zone Controller	Low Ambient Kit	Controller Module	
PCHLLN000	4 Zones by thermostat ABZCA	For MULTI V IV, 5 PRVC2	Main Module PAHMM000	
ACU IO Module UIO	Independent Power Module	Cool / Heat Selector		
PEXPMB300	PRIP0	PRDSBM	Communication Module PAHCM000	
UO			Control Kit	
PEXPMB200			PAHCNM000 (Max. 3 Outdoor Units)	
UI			Water Communication Module	
PEXPMB100			PAHCMW000	
EEV Kit (Electronic Expansion Valve)				
	PRLK048A0 (- 28 kW) PRLK096A0 (- 56 kW)	PRLK396A0 (- 112 kW)	PRLK594A0 (- 168kW)	

028-117

OUTDOOR UNITS

MULTI V 5 / MULTI V S / MULTI V M / MULTI V WATER IV (HEAT PUMP / HEAT RECOVERY)

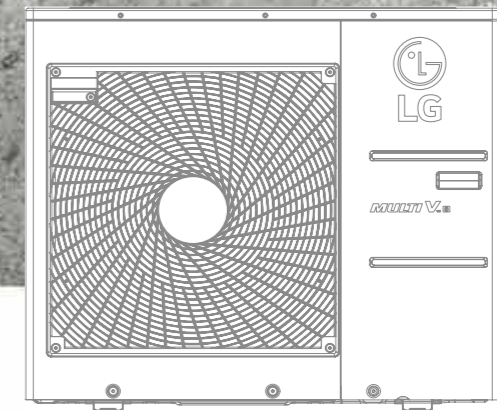
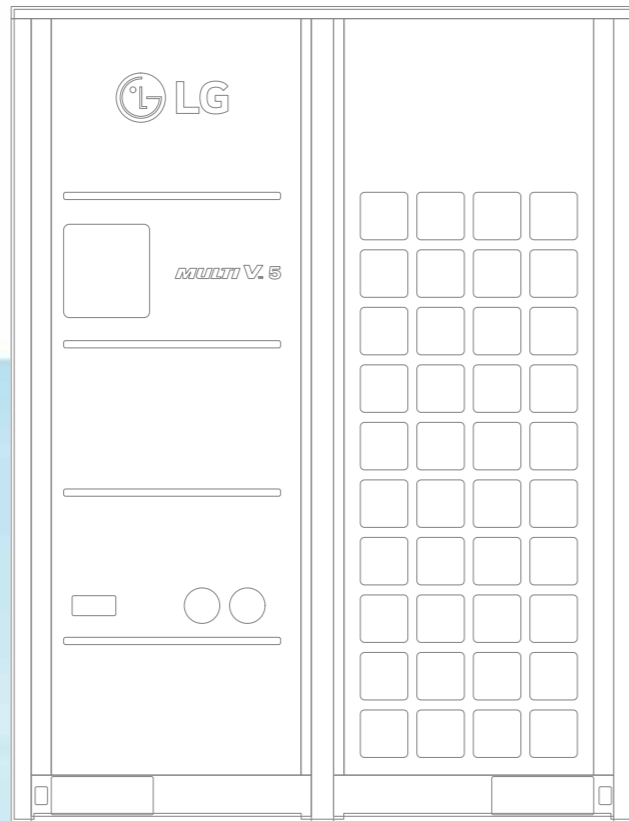

MULTI V™ 5

Highlight

- Air cooled VRF Heat Pump & Heat Recovery
- 22.4kW ~ 268.8kW (Cooling capacity based)
- 3Ø, 380 ~ 415V, 50Hz
- Top discharge outdoor unit
- Ability to function as Heat Pump or Heat Recovery



Energy savings



Reliability



Low noise



Advanced performance

How does it work?

Dual Sensing



Partial Defrost



Interchangeable between heat pump and heat recovery

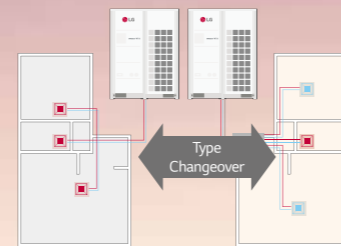

OUTDOOR UNITS

MULTI V.5

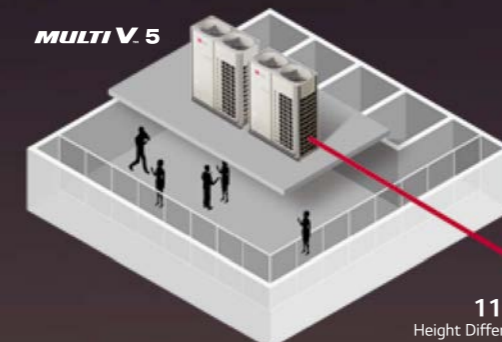

225m
Longest Piping Length

110m
Height Difference
between ODU - IDU

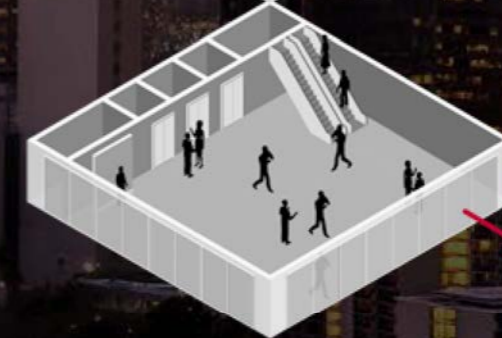
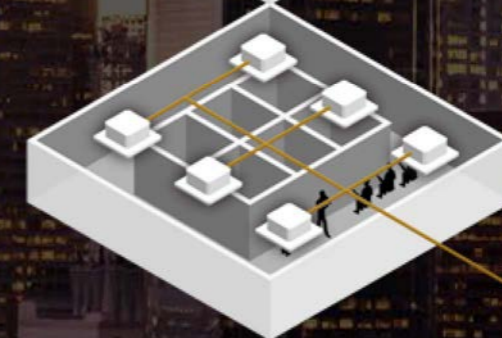
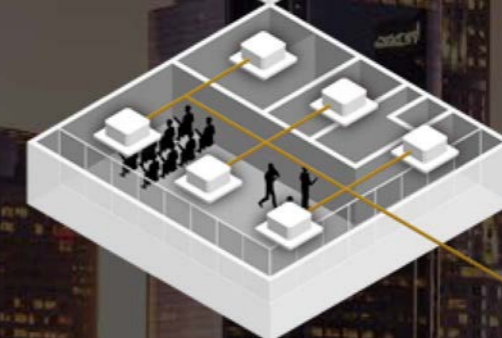
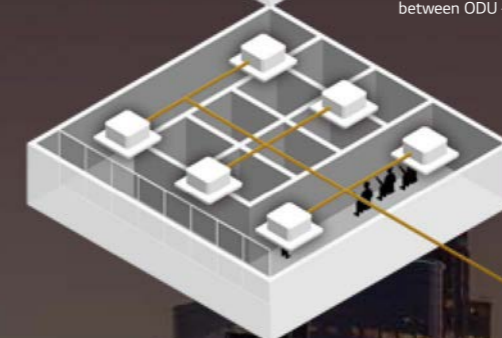

TOTAL PIPING LENGTH
1,000M

40m
Height Difference
between IDU - IDU

Dual Sensing Smart Load Control (SLC)

Enhanced energy saving & increased indoor comfort

Smart Load Control responds to :

- 1) Outdoor ambient dry bulb temperature
- 2) Outdoor ambient relative humidity (when enabled)

Cooling Indoor Units
adjusts target low pressure
Raises the target low pressure value as cooling load falls and/or ambient temperature falls. Lowers the target low pressure value as cooling load rises and/or ambient temperature rises.

Heating Indoor Units
adjusts target high pressure
Lowers the target high pressure as heating load falls and/or ambient temperature rises. Raises the target high pressure as heating load rises and/or ambient temperature falls.

What are the benefits?

Enhanced energy savings

Cooling Mode
By raising the target low pressure during off-peak cooling operation.

Heating Mode
By lowering the target high pressure during off-peak heating operation.

Increased indoor comfort

Operation under the revised weather conditions before changing conditions impact indoor comfort.

Cooling load according to temperature change

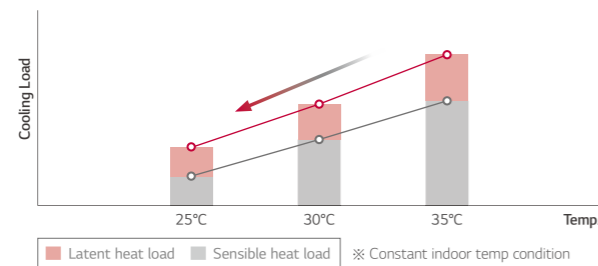

Cooling load according to humidity change

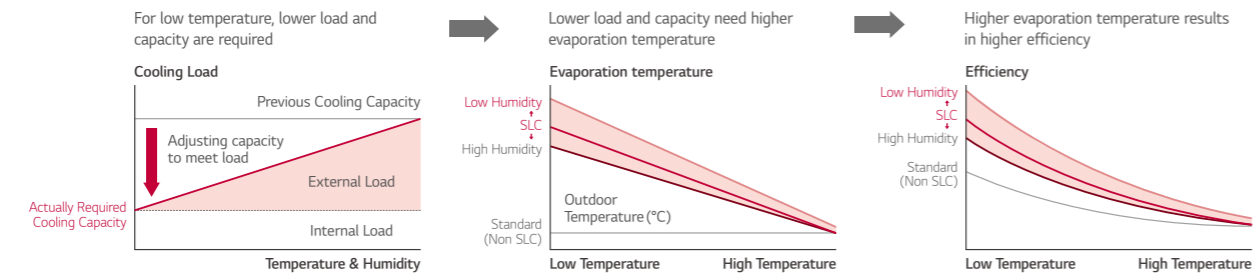
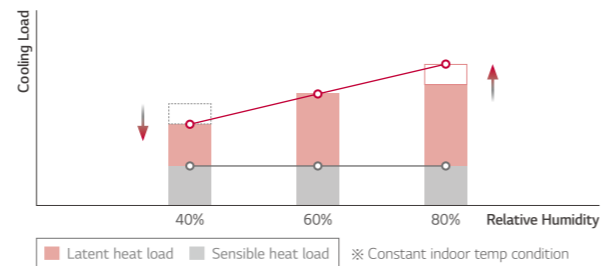

Energy Savings with Dual Sensing Control Temperature & Humidity

Energy Consumption in Cooling Season

Dual sensing SLC control can save 6% more energy compared to SLC. So dual sensing control is more efficient than SLC.

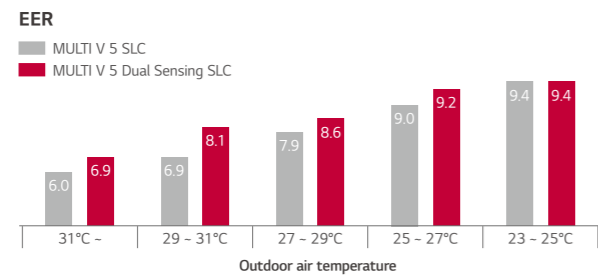

※ This energy simulation was performed in LG internally based on 16HP model.

Power Consumption in Cooling Season

Yearly Power Input (kWh) - ODU

OAT	MV4 (Fixed)	MV5 SLC	MV5 Dual SLC
31 ~	17	15	13
29 ~ 31	91	73	62
27 ~ 29	183	136	124
25 ~ 27	243	170	165
23 ~ 25	155	110	109
Total	690 (137%)	503 (100%)	474 (94%)

6% more energy saving compared to SLC

Comfort Cooling

Increased indoor comfort & enhanced operating efficiency

MULTI V 5's comfort control algorithm monitors the outdoor air temperature and humidity conditions. When changing weather conditions are deteriorating and there is a high potential the indoor unit's load will remain stable or may increase, comfort cooling delays or abandons raising the target superheat as the room temperature approaches set-point. When changing weather conditions are favorable to raising target superheat, target superheat is moderated.

What are the benefits?

With comfort cooling turned on, the discharged air temperature is controlled. When the IDU controller reduces the fan speed, the potential for cold air falling on occupants located under the cassette IDU or supply air registers is reduced.

Enhanced operating efficiency

Raising superheat reduces refrigerant volume flowing through the coil.



※ Indoor unit set up available with Standard III Remote Controller

Preventing cold draft & repeated turn On / Off

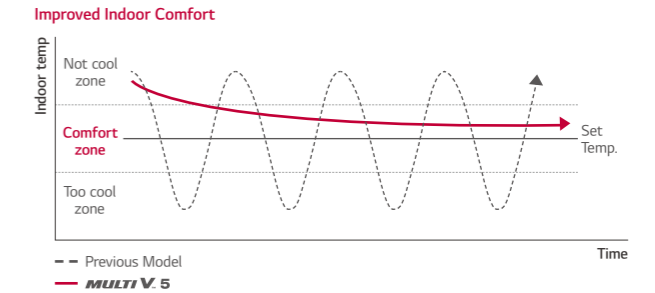

Intelligent Defrost

Increased heating run-hours

MULTI V has provided an intelligent defrost algorithm and settings based on current outdoor ambient temperature. With the addition of the outdoor air humidity sensor, MULTI V 5 Intelligent Defrost just got smarter.

What are the benefits?

The Intelligent Defrost algorithm increases the VRF system's heating run-hours and reduces the number of defrost cycles required to maintain optimum heating performance irrelevant of the mode and method of defrost selected.

Conventional Defrost

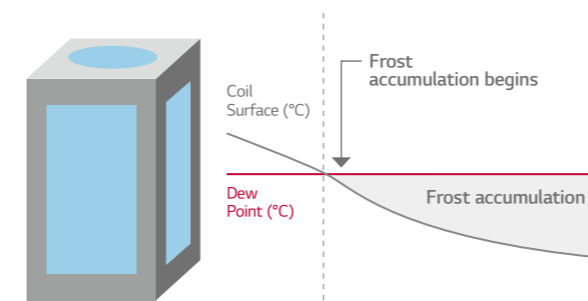

LG Intelligent Defrost / Smart Heating

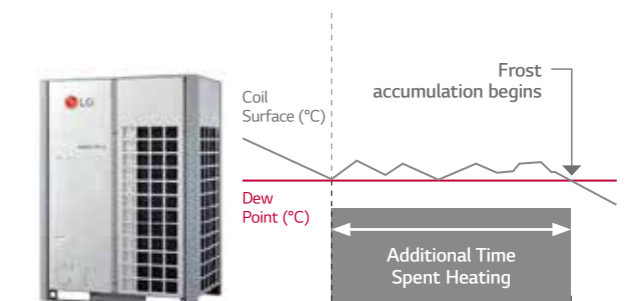

※ Increased heating operation time per day : Up to 17%
 • LG Internal Test result,
 • Test condition (MULTI V 5 vs MULTI V IV, 22HP)
 - Outdoor : 2/1°C, Indoor : 20/15°C
 - Humidity : 83%, Dew Point : -0.5°C

Variable Path Heat Exchanger

Optimized system efficiency & continuous heating

This split coil feature makes it possible for MULTI V 5 to provide continuous heating during defrost. The split coil and valve arrangement also makes it possible for the MULTI V 5 to change the flow path of refrigerant through one of the two coils only, or through both coils in either a series or a parallel arrangement.

What are the benefits?

Optimizes system efficiency regardless of operating modes as ambient weather conditions change. Customizes the used area of the outdoor unit's heat exchange surface.

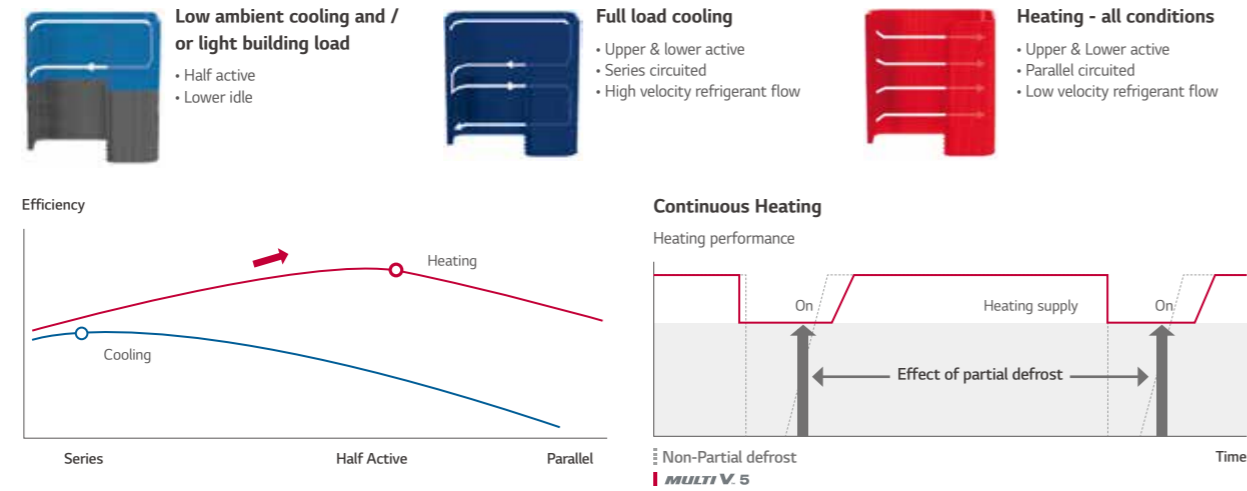

Active Refrigerant Control

Stable operation & sustaining most efficient operation

MULTI V 5 active refrigerant control algorithm goal is to minimize the amount of refrigerant in circulation. The lower the volume in circulation, the lower the cost to move it around the system and the higher the stability of the refrigeration cycle.

What are the benefits?

Widens the ambient temperature range at which stable operation occurs. Sustains most efficient system operation regardless of outdoor weather conditions, operating mode, or building load.

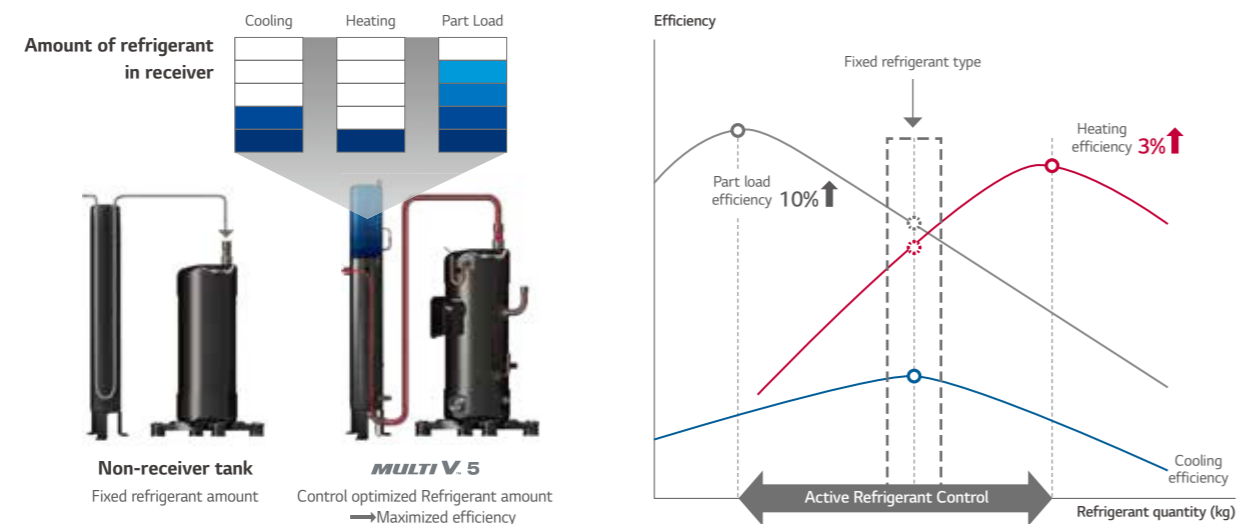

HiPOR™

Advanced compressor reliability & efficiency

HiPOR™ is an LG trademark that stands for High Pressure Oil Return. It consists of an oil separator, oil drain line between the separator and the compressor. HiPOR™ technology enables oil to return directly into the compressor, instead of returning through the refrigerant suction pipe.

What are the benefits?

Maximizes reliability and efficiency of the compressor

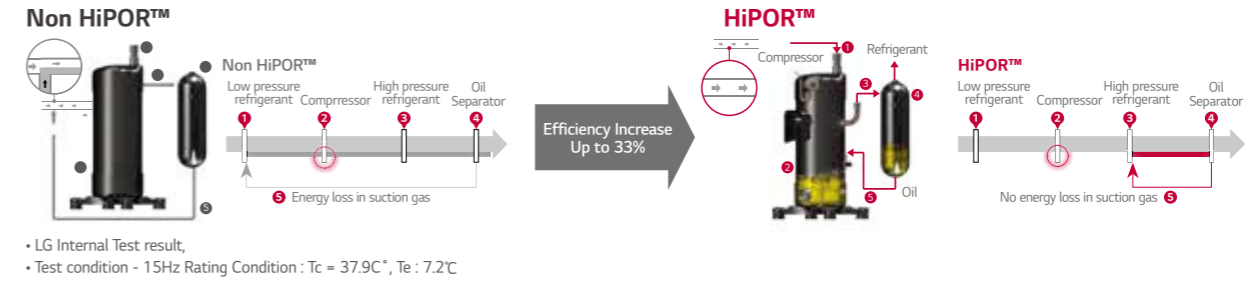

Smart Oil Management

Energy saving, enhanced heating & increased compressor

MULTI V 5 performs oil return when needed under normal operating conditions. An oil level sensor is provided in every LG VRF compressor. If the sensor indicates the compressor oil level is low, the main system processor is notified that an oil return cycle is necessary. LG's unique oil level measuring sensor actively monitors the oil level in each compressor.

What are the benefits?

Energy savings : fewer oil return cycles eliminate unnecessary energy consumption. Increases system heating run-time during winter operation. Increases compressor reliability.

Heating performance

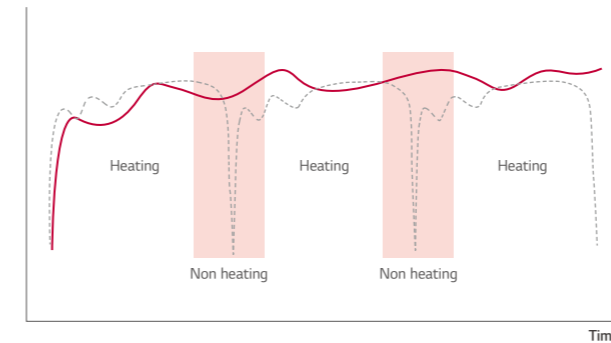

Timed oil return logic (Non-oil Sensor)
MULTI V. 5

Increased heating operation time per day : Up to 12%

- LG Internal Test result,
- Test condition
- without oil level sensor : every 8 hour oil recovery operation
- with oil level sensor : non oil recovery operation

Smart Oil Return

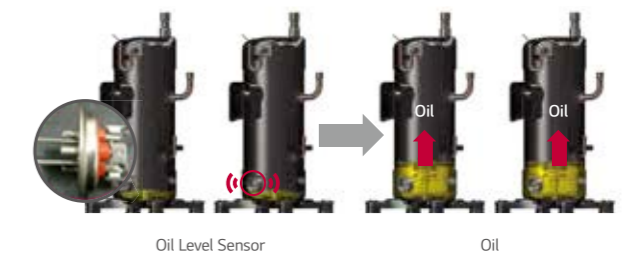

Auto Oil Balancing

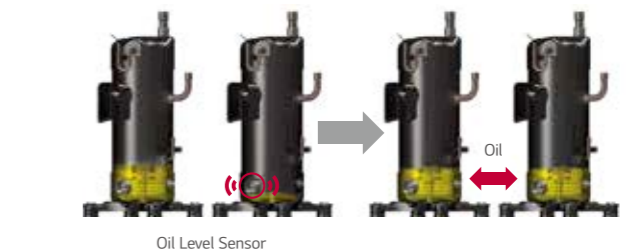

Sub-cooling & Vapor Injection

Increased heating performance

MULTI V 5 is equipped with advanced sub-cooler and vapor injection control system. The sub-cooler algorithm sub-cools liquid refrigerant just enough so that it can travel to the farthest IDU in the system operating in cooling mode without changing state. In all cases, the vapor injection increases the compressors cycle efficiency and reduces operating cost.

What are the benefits?

Provides stable refrigeration cycle operation over a wide range of outdoor ambient operating conditions. Increases compressor efficiency when compared to systems without vapor injection technology.

Technology Mechanism

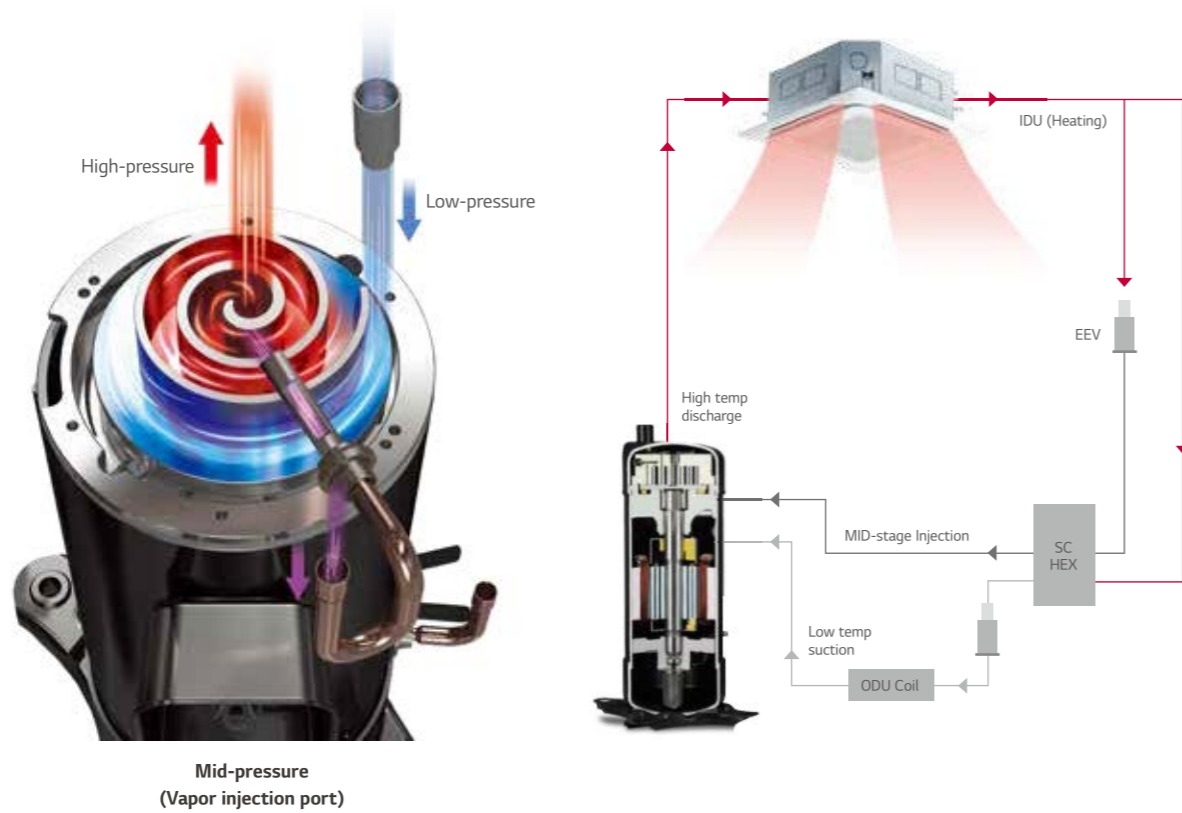

Performance Comparison

Heating performance

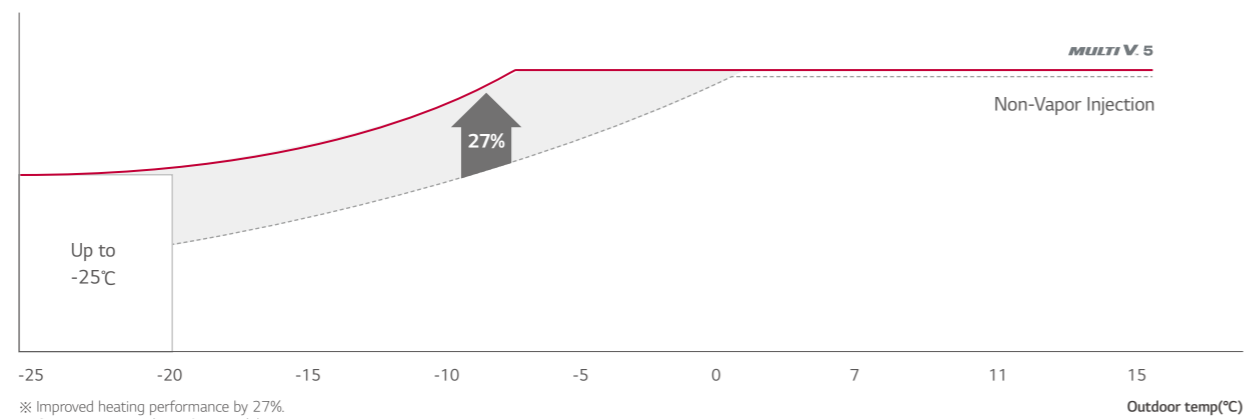

※ Improved heating performance by 27%.
 ※ Comparison tested on 10HP model.

Corrosion Resistance Black Fin

Improved durability

LG Corrosion Resistance solution passed ISO 21207 accelerated corrosion test conducted by an independent test organization and the result has been certified by prestigious global certification organization, TÜV.

What are the benefits?

This improvement in durability prolongs the product's lifespan and lowers both the operational and maintenance costs.



※ Verification of corrosion resistance performance
 - Declared by TÜV Rheinland
 - Test Method B of ISO 21207
 - Test condition : Salt contaminated condition + severe industrial / traffic environment (NO₂ / SO₂)

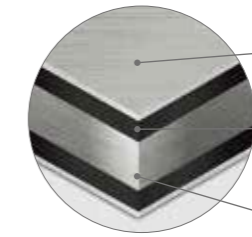

Hydrophilic film (Water flow)
 The Hydrophilic coating minimizes moisture buildup on the fin.

Acryl + Epoxy + Melamine resin (Corrosion resistant)
 The Black coating provides strong protection from corrosion.

Aluminum fin

SST (Salt Spray Test)

Test Process



Test process is conducted according to ISO 9227.
 1) Salty water concentration : NaCl aqueous solution (5%)

Test Result

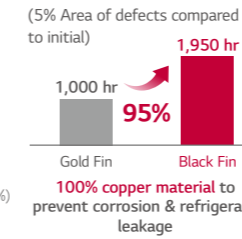

CCT (Cyclic Corrosion Test)

Test Process

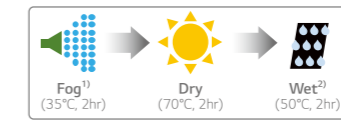

※ Test process is conducted according to ISO 14933.
 1) Salty water concentration : NaCl aqueous solution (5%)
 ※ Dry condition changed : 60°C, 4hr → 70°C, 2hr
 2) Deionized water

Test Result

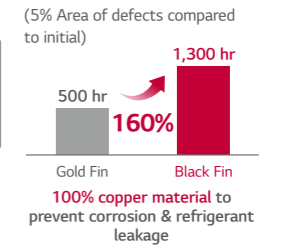

Biomimetic Fan

Maximized performance

The biomimetic technology-based fans, extended shroud of MULTI V 5 allows more high static pressure and helps fans to blow higher air volume for efficient operation. With wider air guide, discharged air current is stabilized and noise level is reduced.

What are the benefits?

Based on the biomimetic technology, the fans of MULTI V 5 increased air flow rate by 10% in comparison to previous model and reduced its power consumption up to 20% when compared with the fan blade design on MULTI V IV. This eventually results in maximized performance with large capacity.



Air flow rate
 m³/min

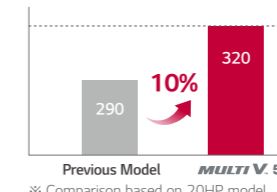

Power consumption
 W

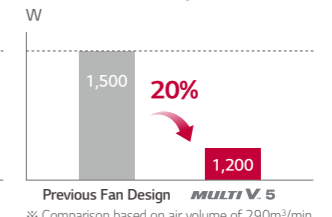

One Unified Model

Heat pump / Heat recovery with one platform

LG MULTI V 5 satisfies users' various needs with just one platform.

What are the benefits?

MULTI V 5 allows the building previously installed with Heat Pump system to switch to the Heat Recovery system (by adding HR boxes and a third pipe) for changing purpose of the building or remodeling reasons via simple piping construction.

Heat Pump System

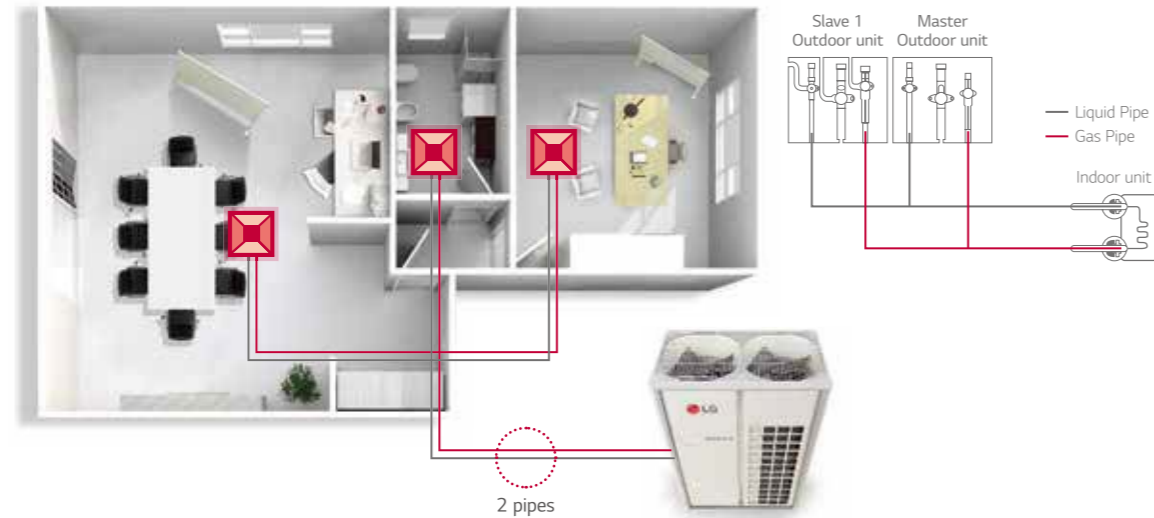

Heat Recovery System

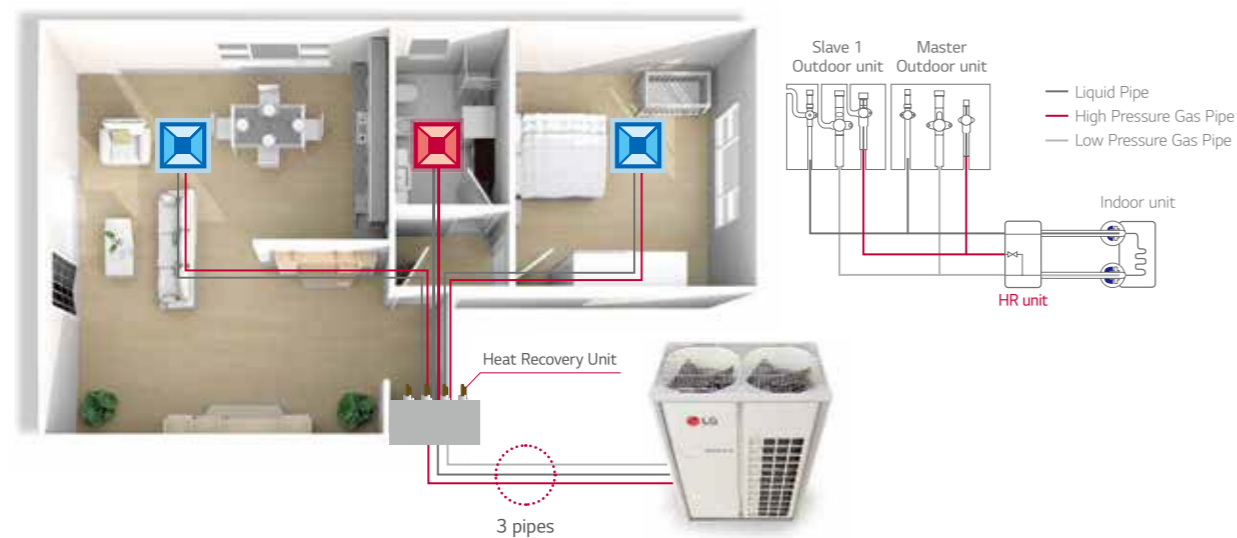

Flexible Installation with Large Capacity Outdoor Units

More flexible design potential & space saving

Large capacity outdoor units of MULTI V 5 minimizes installation space that spares valuable floor space and significantly decreases total installed weight.



Foot print area

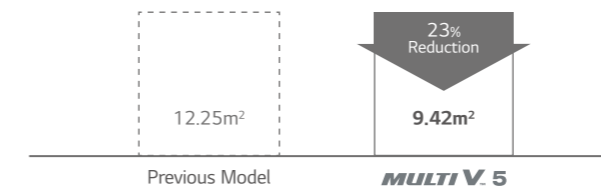

Product weight

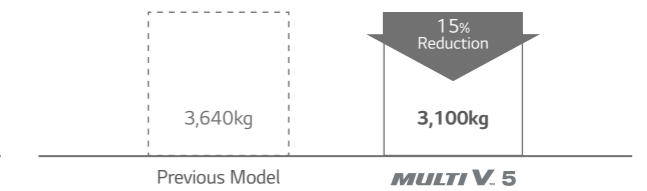

※ Comparison basis : 1 Rows of outdoor units 728kW (72.8kW x 10sets) installation case

Wider Operation Range

Able to operate at extreme conditions

With improved inverter cooling technology, sub-cooling and vapor injection, MULTI V 5 offers an extended range of heating and cooling operations. Moreover, MULTI V 5's cycle technology with enhanced durability enables optimal cooling performance at high temperature that increases up to 48°C.

Heating

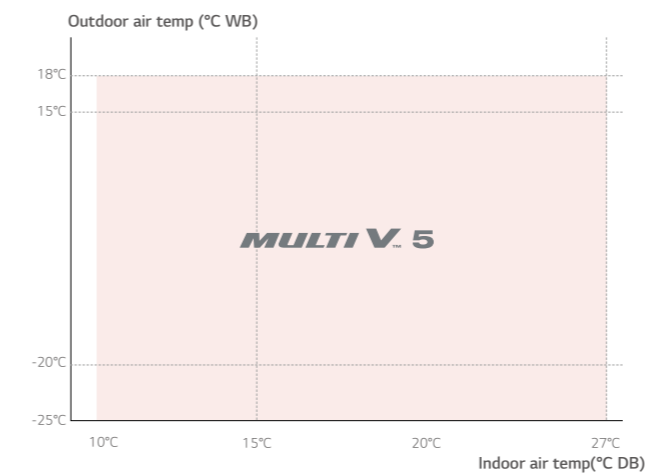

Cooling

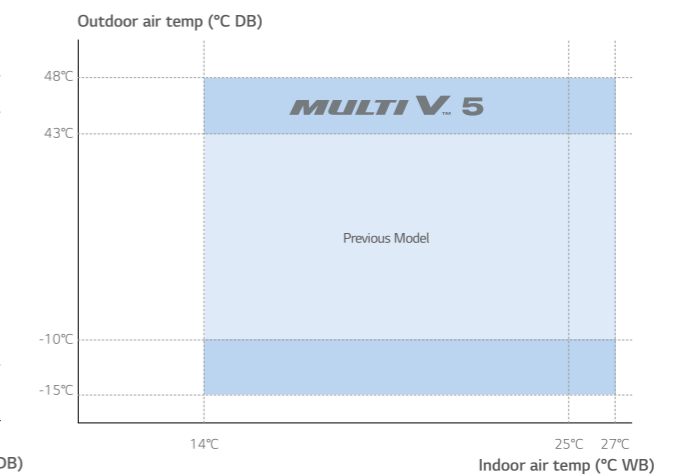

Low-Noise Operation

For noise sensitive environment

The Low-Noise Operation of MULTI V 5 can function regardless of the time at the noise sensitive areas.

Previous Model

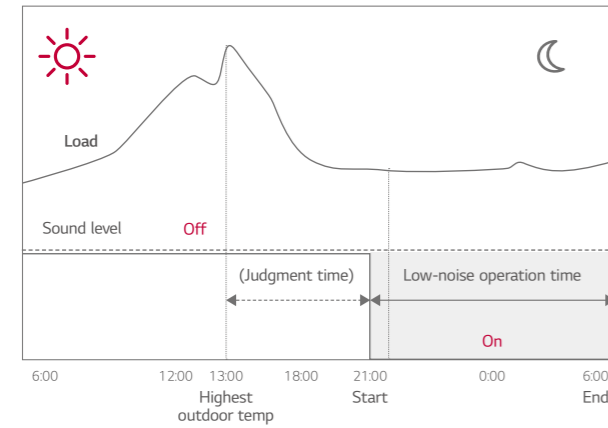

MULTI V 5

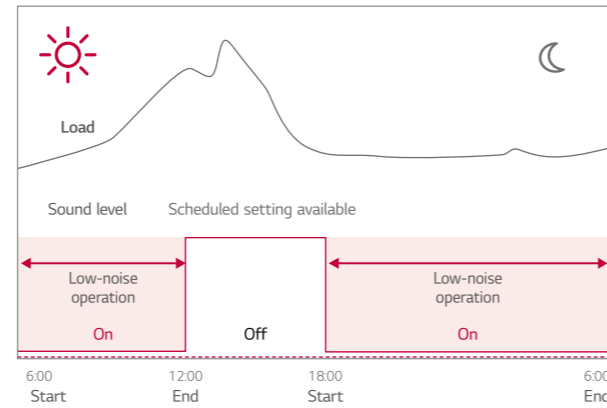

Simple Test Run via LGMV

Increased overall efficiency in installation

With Mobile LGMV of MULTI V 5, fast and accurate auto test run can be executed and the professional installer running the test can receive test results via email, which shortens installation hours and increases overall efficiency in installation processes.

Previous



MULTI V 5



LGMV



Cycle Monitoring Diagnosis Installation Smart Management

Nomenclature

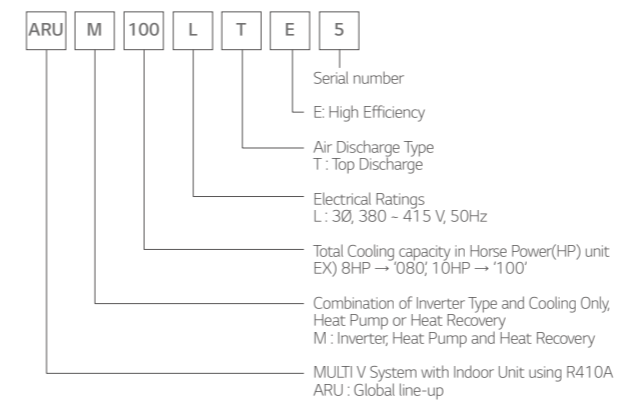

Position of Sound Pressure Level Measuring

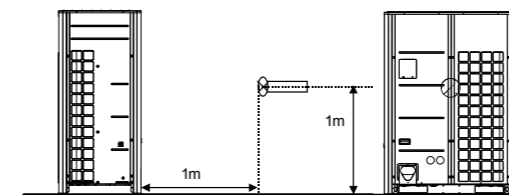

- Data is valid at free field condition
- Data is valid at nominal operating condition
- Sound level will vary depending on a range of factors such as the construction (Acoustic absorption coefficient) of particular room in which the equipment is installed
- Sound level can be increased in static pressure mode or used air guide.

Outdoor Units Function

Category	Functions	MULTI V 5
Key Refrigerant Components	Variable Path of Outdoor Unit HEX	○
	HiPOR™ (High Pressure Oil Return)	○
	Humidity Sensor	○
	Corrosion Resistance Black Fin	○
	Oil Sensor	○
Useful Function	Dual Sensing	○
	Low Noise Operation	○
	Hgh Static Mode of Outdoor Unit Fan	○
	Partial Defrosting	○
	Auto Dust Removal of Outdoor Unit (Fan reverse rotation)	○
	Indoor Cooling Comfort Mode Based Outdoor Temperature	○
	Smart Load Control (SLC) (Changing indoor discharge air temperature according to load)	○
	Outdoor Unit Control Refer to Humidity	○
	Defrost / Deicing	○
	High Pressure Switch	○
Reliability	Phase Protection	○
	Restart Delay (3-minutes)	○
	Self Diagnosis	○
	Soft Start	○
Central Controller	Test Run Function	○
	AC Ez (Simple Controller)	PQCSZ250S0
	AC Ez Touch	PACEZA000
	AC Smart IV	PACS4B000
	AC Smart 5	PAC5SA000
	ACP (Advanced Control Platform) IV	PACP4B000
	ACP (Advanced Control Platform) 5	PACP5A000
AC Manager 5	PACM5A000	
BNU (Building Network Unit)	ACP Lonworks	PLNWKB000
	ACP BACnet	PQNFB17C0
Installation	Refrigerant Charging Kit	PRAC1
PDI (Power Distribution Indicator)	Standard	PPWRDB000
	Premium	PQNUD1S40
Cool / Heat Selector		PRDSBM
Low Ambient Kit		PRVC2
IO Module (ODU Dry Contact)		PVDSMN000
Cycle Monitoring Device	LGMV	PRCTILO
	Mobile LGMV	PLGMVW100

Cooling / Heating Operation

Cooling

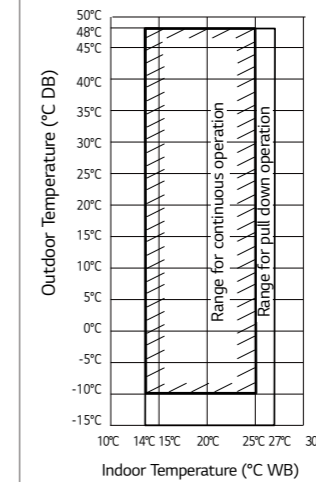

Heating

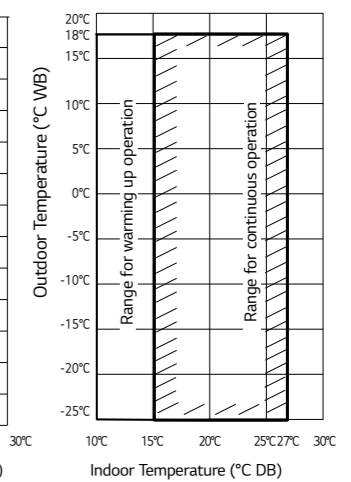

Note

1. These figures assume the following operating conditions :
Equivalent piping length : 7.5m
Level difference : 0m
2. Range of pull down operation :
If the relative humidity is too high, cooling capacity can be decreased by the sensible heat reduction.
3. Warming up operation means that the outdoor unit operates to reach the range of continuous operating, however it may not operate continuously due to safety or protection logic.

Simultaneous Cooling / Heating Operation

Cooling

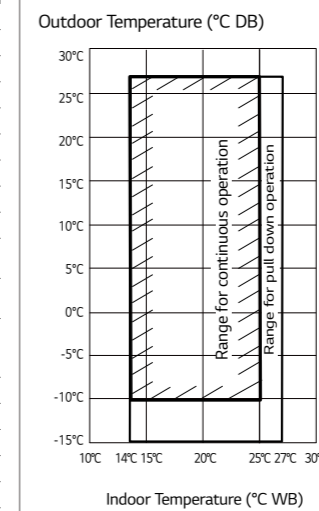

Heating

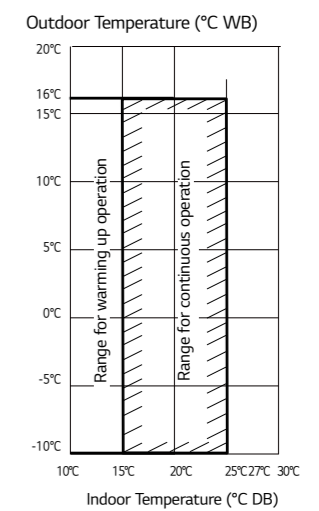

Note

1. These figures assume the following operating conditions :
Equivalent piping length : 7.5m
Level difference : 0m
2. Range of pull down operation :
If the relative humidity is too high, cooling capacity can be decreased by the sensible heat reduction.

ARUM08OLTE5 / ARUM100LTE5 / ARUM120LTE5

[Unit : mm]

No.	Part Name	Description
1	Leakage test hole (Side)	Ø22.2
2	Wire routing hole (Bottom)	2-Ø22.2
3	Power cord routing hole (Bottom)	2-Ø50
4	Pipe routing hole (Front)	-
5	Pipe routing hole (Bottom)	2-Ø66, Ø53.88
6	Power cord routing hole (Front)	2-Ø45
7	Wire routing hole (Front)	2-Ø30

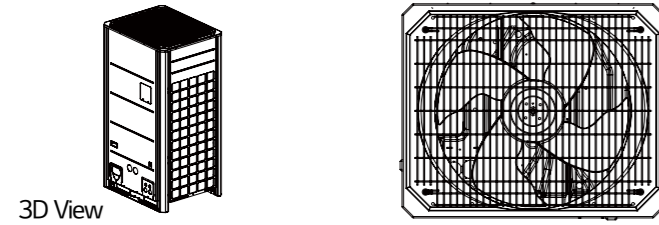

3D View

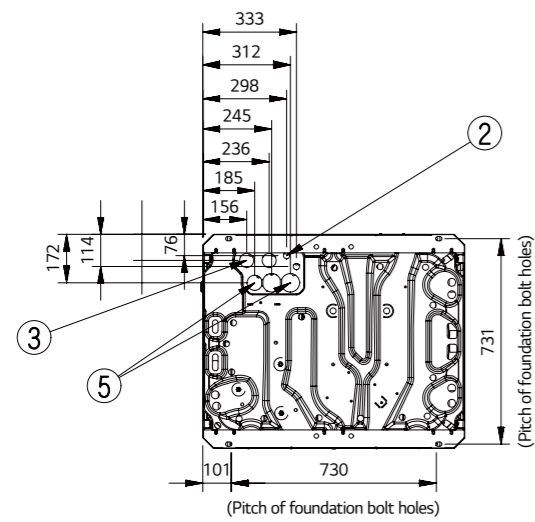
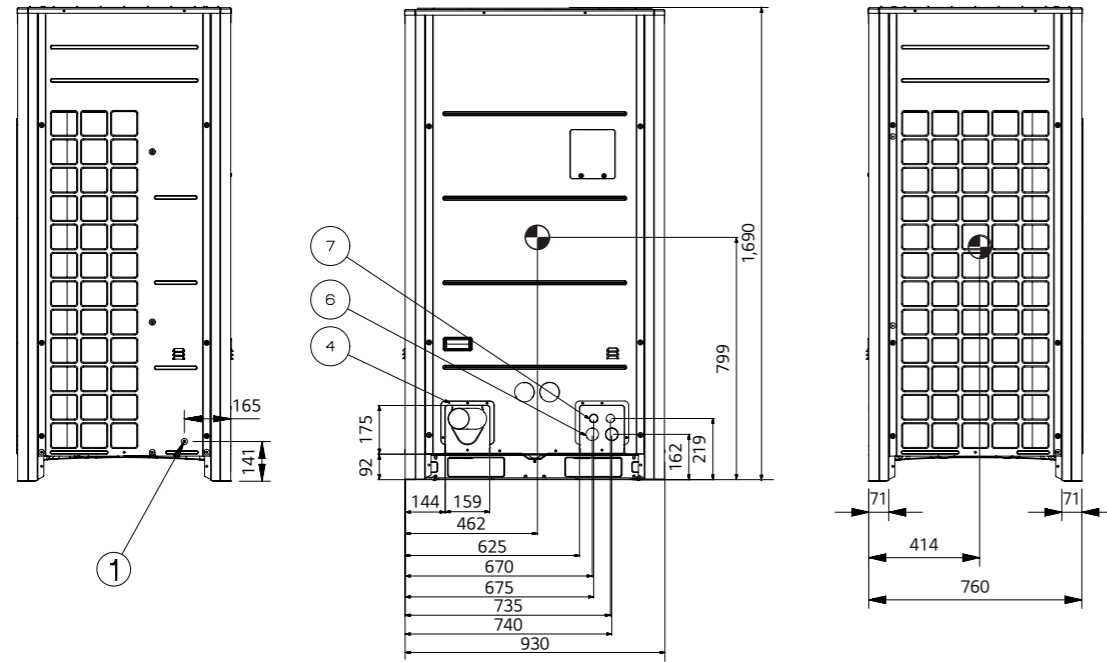

ARUM140LTE5 / ARUM160LTE5 / ARUM180LTE5 / ARUM200LTE5 / ARUM220LTE5 / ARUM240LTE5 / ARUM260LTE5

[Unit : mm]

No.	Part Name	Description
1	Leakage test hole (Side)	Ø22.2
2	Wire routing hole (Bottom)	2-Ø22.2
3	Power cord routing hole (Bottom)	2-Ø50
4	Pipe routing hole (Front)	-
5	Pipe routing hole (Bottom)	2-Ø66, Ø53.88
6	Power cord routing hole (Front)	2-Ø45
7	Wire routing hole (Front)	2-Ø30

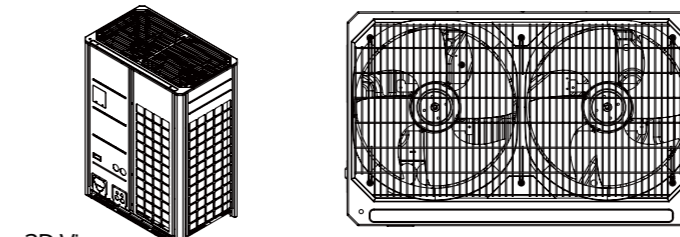

3D View

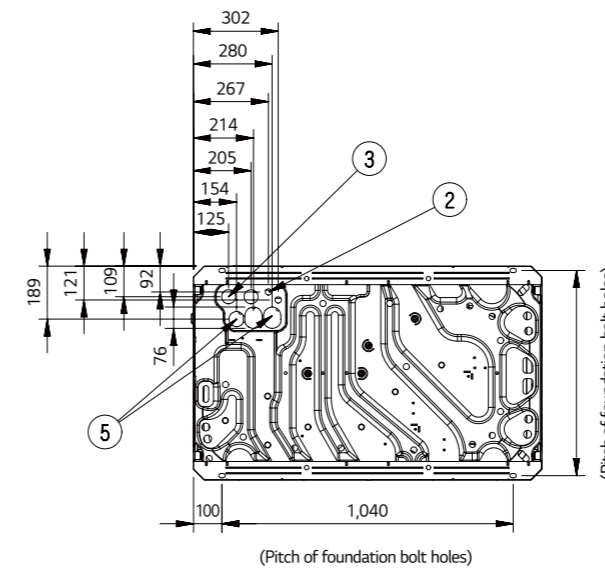
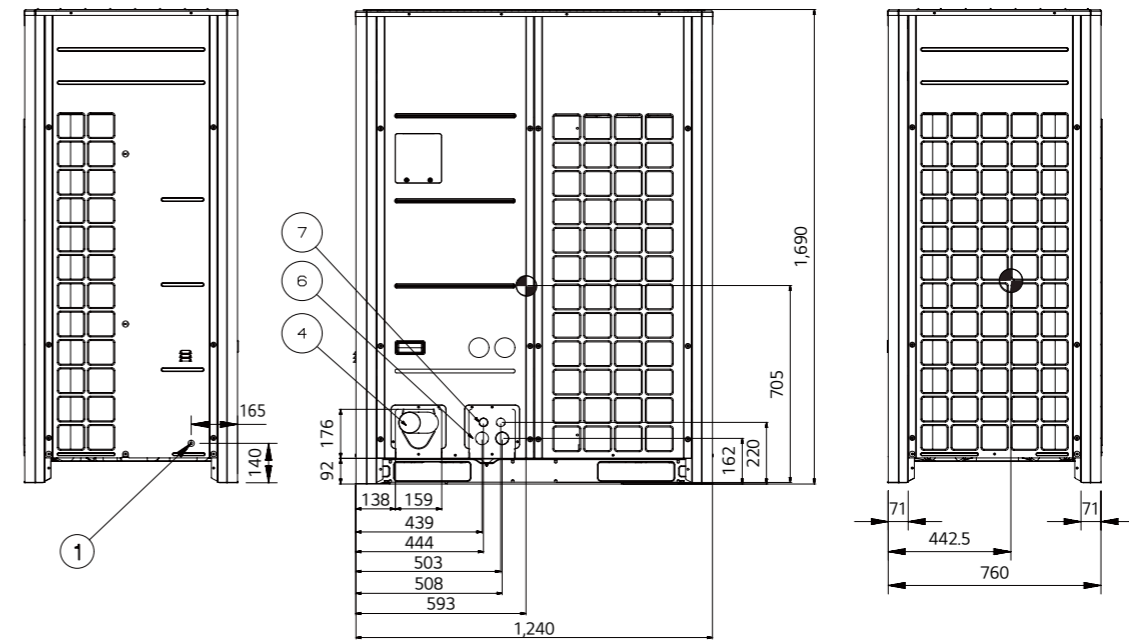

Q1 What are the differences between MULTI V IV and MULTI V 5?

Category	MULTI V IV H/P (ARUN***LTE4)	MULTI V 5 H/P & H/R (ARUM***LTE5)
Vapor Injection	○	○
HiPOR™	○	○
Smart Oil Control (Oil Level Sensor)	○	○
Active Refrigerant Control	○	○
Variable Heat Exchanger Circuit	○	○
Continuous Heating	○	○
Smart Load Control	○	○
Dual sensing (Humidity Sensor)	-	○
Comfort Cooling	○	○
Black Fin	-	○
Maximum Capacity (1 Unit / 4 Unit)	20 HP / 80 HP	26 HP / 96 HP
Height Difference (ODU - IDU / IDU - IDU)	110m / 40m	110m / 40m
Cooling Operating Range (OAT, °CDB)	-10 ~ 43	-15 ~ 48
Heating Operating Range (OAT, °CWB)	-25 ~ 18	-25 ~ 18
Combination ratio of IDU	1 Unit	50 ~ 200%
	2 Unit	50 ~ 160%
	3 or 4 Units	50 ~ 130%

※ ○ : Applied, - : Not Applied

Q2 Can MULTI V 5 ODU be connected with the 2 series indoor unit?

A2 Yes, MULTI V 5 ODU can be connected with the 2 series indoor unit. In this case, the ODU DIP Switch No.3 should be "OFF" which is default setting. Refer to the below table.

ODU	IDU	Compatibility	ODU DIP Switch No. 3	If dip switch setting is not correct	Ref.
MULTI V IV MULTI V 5	Gen. 2 (ARNU*2)	○	Must be OFF (factory default)	Can not communicate between Indoor & Outdoor unit (System will not be operated)	
	Gen. 4 (ARNU*4)	○	Must be ON to enable gen. 4 functions	When Dip Switch No. 3 is OFF, System can be operated, but some function of Gen. 4 is not available	
	Gen. 2 + Gen. 4	○	Must be OFF (factory default)	When Dip Switch No. 3 is ON, Can not communicate between Gen. 2 Indoor & Outdoor unit (Gen 2 units are not operated), only Gen 4 Units are operated.	Some functions of Gen.4 are not available

※ ○ : Applied, - : Not Applied

ODU dip switch setting procedure (No.3)

ODU main PCB dip switch is all "OFF" at default state

- (1) Check and make sure that all connected indoor units are 4 series. (ARNU*****4.)
- (2) Change Dip switch No. 3 from OFF → ON
- (3) Push the reset button.

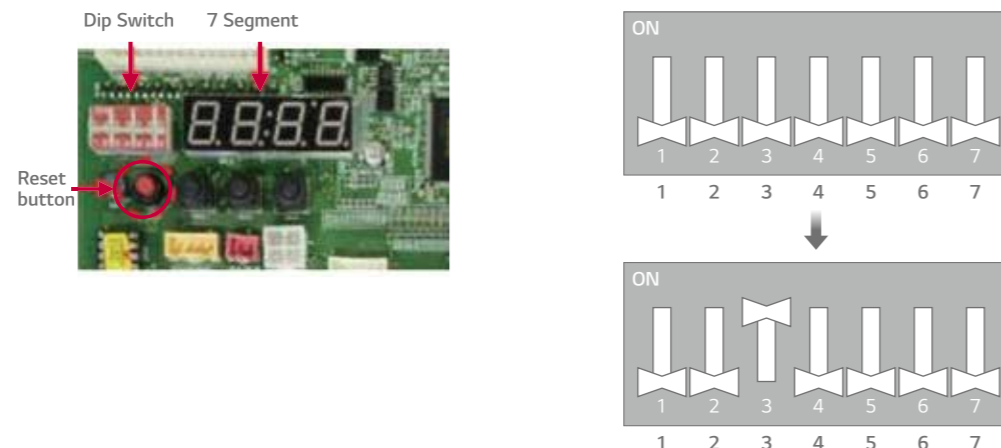

Q3 How does MULTI V 5 operate when humidity reference of the dual sensing SLC is that of the outdoor?

A3 During dual sensing SLC, outdoor unit changes target pressure of the system referring to temperature and humidity in cooling mode.
 - When the humidity of outdoor side is higher than that of indoor side, outdoor unit will lower target pressure to remove humidity, thus outdoor unit will consume more energy and indoor will be more cooled compared to SLC operation but would have higher efficiency as compared to normal operation.

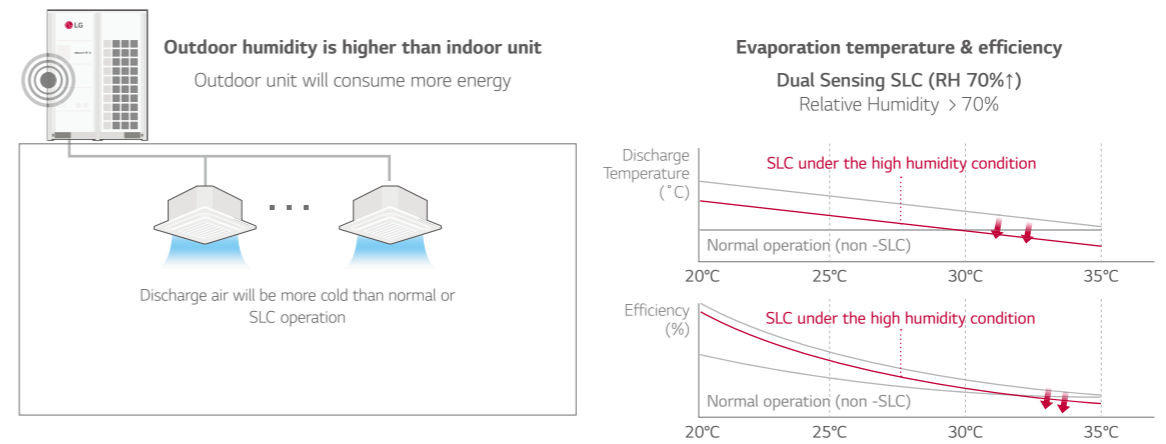

- When the humidity of outdoor side is lower than that of indoor side, outdoor unit will rise target pressure to save energy and keep comfort, but indoor humidity will be less removed compared to normal operation.

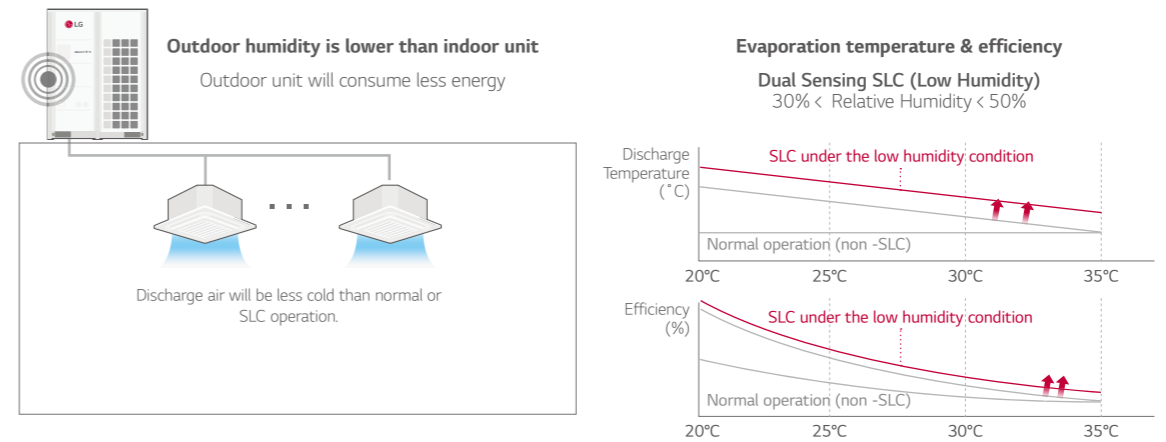

To maximize comfort and energy efficiency, the outdoor unit's humidity sensing can be turned off or a standard remote control can be installed to sense indoor humidity.

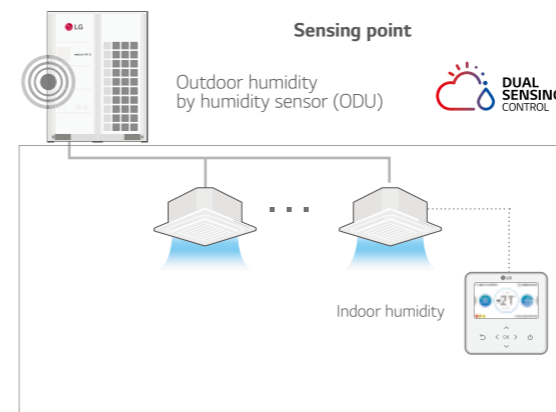

SLC Setting

CASE 1. Dual Sensing SLC with Outdoor humidity sensor in ODU Setting

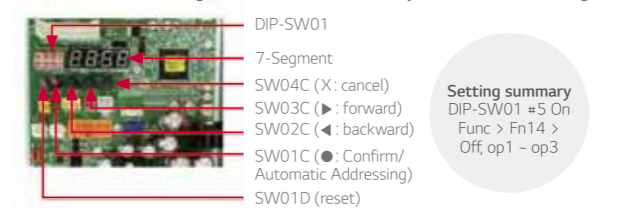

CASE 2. Dual Sensing SLC with Indoor humidity sensor in New Standard R/C setting (PREMTB100)



※ User can turn off humidity control in ODU Setting (humidity reference) <Setting summary> ODU DIP-SW01 #5 On > Func > Fn16 > Off

Q4 What is the principle and accuracy of humidity sensor?

A4 Total Tolerance (%) = Sensor measurement tolerance (%) + Location of sensor tolerance (%)

The capacitive measurement principle established and proved itself as a standard in the past. For this principle, the sensor element is built out of a capacitor. The dielectric is a polymer which absorbs or releases water proportional to the relative environmental humidity, and thus changes the capacitance of the capacitor. This change in capacitance can be measured by an electronic circuit. For humidity sensors with CMOSens® technology, a “micro-machined” finger electrode system with different protective and polymer cover layers forms the capacitance for the sensor chip, and, in addition to providing the sensor property, simultaneously protects the sensor from interference in ways previously not achieved.

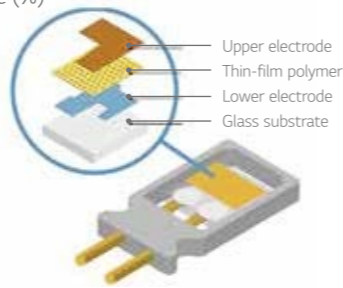

Model	Humidity Sensor of Outdoor	Humidity Sensor of R/Controller
Size (mm)	3 x 3 x 1.1	2.5 x 2.5 x 0.9
Supply voltage range	2.1 to 3.6 V	2.4 to 5.5 V
RH operating range	0 ~ 100% RH	0 ~ 100% RH
T operating range	-40 to +125°C (-40 to +257°F)	-40 to +125°C (-40 to +257°F)
RH response time	8 sec (tau 63%)	8 sec (tau 63%)

Q5 What is difference in refrigerant piping connection between heat pump and heat recovery?

A5 From MULTI V 5, Low pressure gas pipe in heat pump operation changes to high pressure gas pipe in heat recovery operation due to internal cycle. So for heat pump cycle, no. 1, 3 pipe should be connected and for heat recovery operation, No. 1, 2, 3 pipe is connected. (For the heat pump operation, DO NOT connect No.2 pipe)

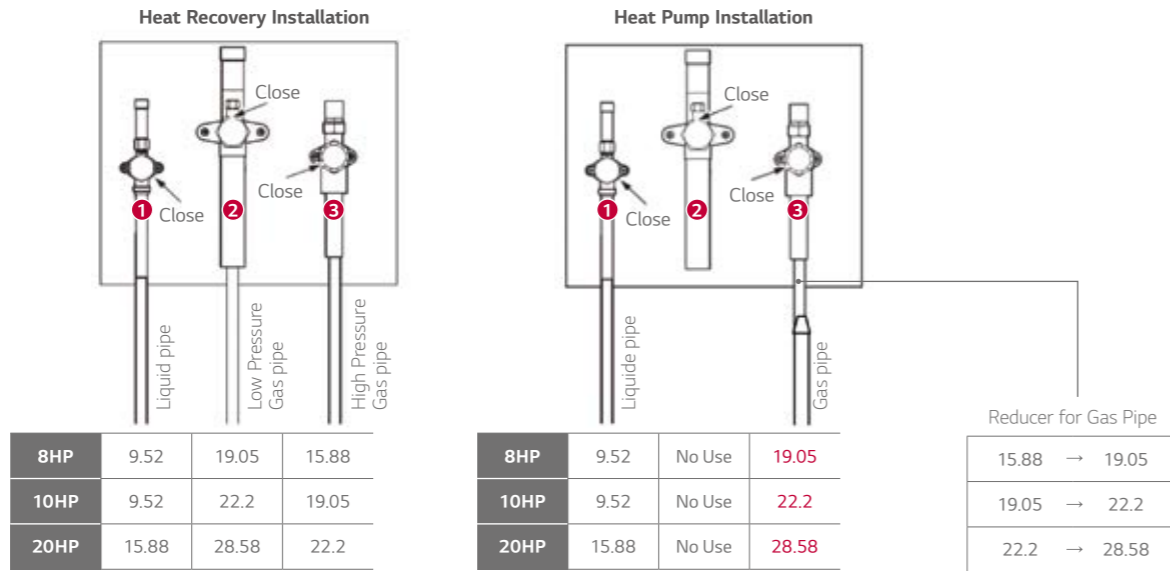

Other Questions

Item	Question	Answer
Fan	The static pressure of MULTI V 5 is Max 8 mmAq as MULTI V IV??	Yes, the static pressure of MULTI V 5 is the same as MULTI V IV.
Compressor	Is the limitation of Compressor max Hz applied by the capacity of outdoor unit?	No, the limitation of comp Hz is not applied for default. But, it can be set by option for limitation of max Hz (or current).
4 Way V/V	The usage of main & sub 4 way valve for MULTI V 5 ?	MULTI V 5 has the function of both H/P and H/R by one unit. Main valve has a function to change the operation mode. (Cooling ↔ Heating) Sub. Valve has a functions to change the product type (H/P ↔ H/R)
VI	In case of vapor injection, how much is the middle pressure?	The optimal middle pressure for vapor injection is 1.2 P _s . P _s : Suction pressure of compressor
VI	By how much is heating capacity increased by vapor injection?	Generally, the heating capacity is increased up to 15 ~ 20%.
Humidity Sensor	Where is Indoor Humidity sensor?	It is placed inside of the RS3 remote controller.
Remote Controller	Does remote controller show the humidity information (Status) as well?	Yes. It shows the current humidity information on screen. (for RS3 Only) But has no function to control the humidity
Remote Controller	Is it possible to connect the local humidity sensor with Remote controller (RS3)?	No. All of RS3 remote controller can not be connected with local humidity sensor.
SLC	Does dual sensing SLC function control the humidity ratio?	No. There is no control of humidity ratio.
SLC	Is SLC fully used on Eurovent? Isn't humidity fixed for the test? What about AHRI?	Eurovent (RH 47%) and AHRI (RH 51%) have fixed humidity test condition.
Comfort Cooling	Why is not the comfort heating applied in product?	Comfort cooling need super heating controlled and Comfort heating need sub cooling controlled. In case of controlling EEV for sub cooling, noise and stable operation may be affected and critical.
Installation	Does the IDU – Central controller direct connection for communication cable is possible? (Flat connection)	No, it is not possible.

ARUM080LTE5 / ARUM100LTE5
ARUM120LTE5 / ARUM140LTE5



LG participates in the ECP programme for EUROVENT VRF program. Check ongoing validity of certification : www.eurovent-certification.com

HP		8	10	12	14
Model Name	Combination Unit	ARUM080LTE5	ARUM100LTE5	ARUM120LTE5	ARUM140LTE5
	Independent Unit	ARUM080LTE5	ARUM100LTE5	ARUM120LTE5	ARUM140LTE5
Capacity	Cooling (Rated) kW	22.4	28.0	33.6	39.2
	Heating (Rated) kW	22.4	28.0	33.6	39.2
	Heating (Max) kW	25.2	31.5	37.8	44.1
	Cooling (Rated) kW	5.28	6.83	7.71	8.67
Input	Heating (Rated) kW	3.97	4.92	6.85	8.48
	Heating (Max) kW	4.78	5.92	8.26	9.72
	EER	4.24	4.10	4.36	4.52
SEER		9.93	9.49	9.57	8.89
COP	Rated Capacity	5.64	5.69	4.91	4.62
	Max Capacity	5.27	5.32	4.58	4.54
SCOP		4.69	4.51	5.01	4.63
Exterior	Color	Morning Gray / Dawn Gray	Morning Gray / Dawn Gray	Morning Gray / Dawn Gray	Morning Gray / Dawn Gray
	RAL Code (Classic)	RAL 7030 / RAL 7037	RAL 7030 / RAL 7037	RAL 7030 / RAL 7037	RAL 7030 / RAL 7037
Heat Exchanger	Type	Wide Louver Plus / Black Fin	Wide Louver Plus / Black Fin	Wide Louver Plus / Black Fin	Wide Louver Plus / Black Fin
	Type	Hermetically Sealed Scroll	Hermetically Sealed Scroll	Hermetically Sealed Scroll	Hermetically Sealed Scroll
Compressor	Combination x No.	(Inverter) x 1	(Inverter) x 1	(Inverter) x 1	(Inverter) x 1
	Motor Output x Number	W x No.	4,200 x 1	5,300 x 1	5,300 x 1
	Oil Type		FVC68D (PVE)	FVC68D (PVE)	FVC68D (PVE)
	Oil Charge	cc	3,900	3,900	3,900
	Fan	Type	Propeller fan	Propeller fan	Propeller fan
Fan	Motor Output x Number	W x No.	1,200 x 1	1,200 x 1	900 x 2
	Air Flow Rate (High)	m ³ /minxNo.	240 x 1	240 x 1	240 x 1
	Drive		DC INVERTER	DC INVERTER	DC INVERTER
	Discharge	Side / Top	TOP	TOP	TOP
	Pipe Connections for Heat Recovery	Liquid Pipe	mm (inch)	Ø9.52 (3/8)	Ø9.52 (3/8)
Low Pressure Gas Pipe		mm (inch)	Ø19.05 (3/4)	Ø22.2 (7/8)	Ø28.58 (1-1/8)
High Pressure Gas Pipe		mm (inch)	Ø15.88 (5/8)	Ø19.05 (3/4)	Ø22.2 (7/8)
Pipe Connections for Heat Pump	Liquid Pipe	mm (inch)	Ø9.52 (3/8)	Ø9.52 (3/8)	Ø12.7 (1/2)
	Gas Pipe	mm (inch)	Ø19.05 (3/4)	Ø22.2 (7/8)	Ø28.58 (1-1/8)
Dimensions (W x H x D)	mm x No.	(930 x 1,690 x 760) x 1	(930 x 1,690 x 760) x 1	(930 x 1,690 x 760) x 1	(1,240 x 1,690 x 760) x 1
Dimensions (W x H x D) - Shipping	mm x No.	(960 x 1,825 x 796) x 1	(960 x 1,825 x 796) x 1	(960 x 1,825 x 796) x 1	(1,280 x 1,825 x 796) x 1
Net Weight	kg x No.	198 x 1	215 x 1	215 x 1	237 x 1
Shipping Weight	kg x No.	208 x 1	225 x 1	225 x 1	250 x 1
Sound Pressure Level	Cooling	dB(A)	58.0	58.0	59.0
	Heating	dB(A)	59.0	59.0	60.0
Sound Power Level	Cooling	dB(A)	79.0	79.0	81.0
	Heating	dB(A)	79.0	79.0	81.0
Communication Cable	mm ² x No. (VCTF-SB)	1.0 - 1.5 x 2C	1.0 - 1.5 x 2C	1.0 - 1.5 x 2C	1.0 - 1.5 x 2C
Refrigerant	Refrigerant Name		R410A	R410A	R410A
	Precharged Amount in Factory	kg	7.5	9.5	9.5
	t-CO ₂ ,eq		15.656	19.831	19.831
Control			Electronic Expansion Valve	Electronic Expansion Valve	Electronic Expansion Valve
			Electronic Expansion Valve	Electronic Expansion Valve	Electronic Expansion Valve
Power Supply	Ø, V, Hz	3, 380-415, 50	3, 380-415, 50	3, 380-415, 50	3, 380-415, 50
Number of Maximum Connectable Indoor Units ¹⁾		13 (20)	16 (25)	20 (30)	23 (35)

¹⁾ Maximum numbers are prepared based on assumption that all 2.2kW indoor units are connected. The numbers in parentheses means maximum connectable indoor units in accordance with outdoor units combination (160% - 200%). The recommended ratio is 130%.

ARUM160LTE5 / ARUM180LTE5
ARUM200LTE5 / ARUM220LTE5



LG participates in the ECP programme for EUROVENT VRF program. Check ongoing validity of certification : www.eurovent-certification.com

HP		16	18	20	22
Model Name	Combination Unit	ARUM160LTE5	ARUM180LTE5	ARUM200LTE5	ARUM220LTE5
	Independent Unit	ARUM160LTE5	ARUM180LTE5	ARUM200LTE5	ARUM220LTE5
Capacity	Cooling (Rated) kW	44.8	50.4	56.0	61.6
	Heating (Rated) kW	44.8	50.4	56.0	61.6
	Heating (Max) kW	50.4	56.7	63.0	69.3
	Cooling (Rated) kW	10.90	11.03	12.76	15.92
Input	Heating (Rated) kW	10.28	10.12	12.20	14.15
	Heating (Max) kW	12.39	11.94	14.69	16.76
	EER	4.11	4.57	4.39	3.87
SEER		8.38	8.21	8.05	7.49
COP	Rated Capacity	4.36	4.98	4.59	4.35
	Max Capacity	4.07	4.75	4.29	4.13
SCOP		4.83	4.0	3.98	3.9
Exterior	Color	Morning Gray / Dawn Gray	Morning Gray / Dawn Gray	Morning Gray / Dawn Gray	Morning Gray / Dawn Gray
	RAL Code (Classic)	RAL 7030 / RAL 7037	RAL 7030 / RAL 7037	RAL 7030 / RAL 7037	RAL 7030 / RAL 7037
Heat Exchanger	Type	Wide Louver Plus / Black Fin	Wide Louver Plus / Black Fin	Wide Louver Plus / Black Fin	Wide Louver Plus / Black Fin
	Type	Hermetically Sealed Scroll	Hermetically Sealed Scroll	Hermetically Sealed Scroll	Hermetically Sealed Scroll
Compressor	Combination x No.	(Inverter) x 1	(Inverter) x 2	(Inverter) x 2	(Inverter) x 2
	Motor Output x Number	W x No.	5,300 x 1	(5,300 x 1) + (4,200 x 1)	(5,300 x 1) + (4,200 x 1)
	Oil Type		FVC68D (PVE)	FVC68D (PVE)	FVC68D (PVE)
	Oil Charge	cc	3,900	5,200	5,200
	Fan	Type	Propeller fan	Propeller fan	Propeller fan
Fan	Motor Output x Number	W x No.	900 x 2	900 x 2	900 x 2
	Air Flow Rate (High)	m ³ /minxNo.	320 x 1	320 x 1	320 x 1
	Drive		DC INVERTER	DC INVERTER	DC INVERTER
	Discharge	Side / Top	TOP	TOP	TOP
	Pipe Connections for Heat Recovery	Liquid Pipe	mm (inch)	Ø12.7 (1/2)	Ø15.88 (5/8)
Low Pressure Gas Pipe		mm (inch)	Ø28.58 (1-1/8)	Ø28.58 (1-1/8)	Ø28.58 (1-1/8)
High Pressure Gas Pipe		mm (inch)	Ø22.2 (7/8)	Ø22.2 (7/8)	Ø28.58 (1-1/8)
Pipe Connections for Heat Pump	Liquid Pipe	mm (inch)	Ø12.7 (1/2)	Ø15.88 (5/8)	Ø15.88 (5/8)
	Gas Pipe	mm (inch)	Ø28.58 (1-1/8)	Ø28.58 (1-1/8)	Ø28.58 (1-1/8)
Dimensions (W x H x D)	mm x No.	(1,240 x 1,690 x 760) x 1	(1,240 x 1,690 x 760) x 1	(1,240 x 1,690 x 760) x 1	(1,240 x 1,690 x 760) x 1
Dimensions (W x H x D) - Shipping	mm x No.	(1,280 x 1,825 x 796) x 1	(1,280 x 1,825 x 796) x 1	(1,280 x 1,825 x 796) x 1	(1,280 x 1,825 x 796) x 1
Net Weight	kg x No.	237 x 1	300 x 1	300 x 1	300 x 1
Shipping Weight	kg x No.	250 x 1	312 x 1	312 x 1	312 x 1
Sound Pressure Level	Cooling	dB(A)	60.5	61.0	62.0
	Heating	dB(A)	61.5	62.0	64.5
Sound Power Level	Cooling	dB(A)	85.0	87.0	89.0
	Heating	dB(A)	86.0	87.0	90.0
Communication Cable	mm ² x No. (VCTF-SB)	1.0 - 1.5 x 2C	1.0 - 1.5 x 2C	1.0 - 1.5 x 2C	1.0 - 1.5 x 2C
Refrigerant	Refrigerant Name		R410A	R410A	R410A
	Precharged Amount in Factory	kg	13.5	16.0	16.0
	t-CO ₂ ,eq		28.181	33.400	33.400
Control			Electronic Expansion Valve	Electronic Expansion Valve	Electronic Expansion Valve
			Electronic Expansion Valve	Electronic Expansion Valve	Electronic Expansion Valve
Power Supply	Ø, V, Hz	3, 380-415, 50	3, 380-415, 50	3, 380-415, 50	3, 380-415, 50
Number of Maximum Connectable Indoor Units ¹⁾		26 (40)	29 (45)	32 (50)	35 (56)

¹⁾ Maximum numbers are prepared based on assumption that all 2.2kW indoor units are connected. The numbers in parentheses means maximum connectable indoor units in accordance with outdoor units combination (160% - 200%). The recommended ratio is 130%.

ARUM240LTE5 / ARUM260LTE5
ARUM221LTE5 / ARUM241LTE5



2) LG participates in the ECP programme for EUROVENT VRF program. Check ongoing validity of certification : www.eurovent-certification.com

HP			24	26	22'	24'
Model Name	Combination Unit		ARUM240LTE5	ARUM260LTE5	ARUM221LTE5	ARUM241LTE5
	Independent Unit		ARUM240LTE5	ARUM260LTE5	ARUM120LTE5 ARUM100LTE5	ARUM120LTE5 ARUM120LTE5
Capacity	Cooling (Rated)	kW	67.2	72.8	61.6	67.2
	Heating (Rated)	kW	67.2	67.2	61.6	67.2
	Heating (Max)	kW	74.3	74.3	69.3	75.6
Input	Cooling (Rated)	kW	17.41	20.22	14.54	15.41
	Heating (Rated)	kW	15.89	15.89	11.77	13.70
	Heating (Max)	kW	18.80	19.15	14.18	16.52
EER		3.86	3.60	4.24	4.36	
SEER		7.88	7.55	-	-	
COP	Rated Capacity		4.23	4.23	5.23	4.91
	Max Capacity		3.95	3.88	4.89	4.58
SCOP		4.34	4.34	-	-	
Exterior	Color		Morning Gray / Dawn Gray	Morning Gray / Dawn Gray	Morning Gray / Dawn Gray	Morning Gray / Dawn Gray
	RAL Code (Classic)		RAL 7030 / RAL 7037	RAL 7030 / RAL 7037	RAL 7030 / RAL 7037	RAL 7030 / RAL 7037
Heat Exchanger	Type		Wide Louver Plus / Black Fin	Wide Louver Plus / Black Fin	Wide Louver Plus / Black Fin	Wide Louver Plus / Black Fin
	Type		Hermetically Sealed Scroll	Hermetically Sealed Scroll	Hermetically Sealed Scroll	Hermetically Sealed Scroll
Compressor	Combination x No.		(Inverter) x 2	(Inverter) x 2	(Inverter) x 2	(Inverter) x 2
	Motor Output x Number	W x No.	5,300 x 2	5,300 x 2	5,300 x 2	5,300 x 2
	Oil Type		FVC68D (PVE)	FVC68D (PVE)	FVC68D (PVE)	FVC68D (PVE)
	Oil Charge	cc	5,200	5,200	7,800	7,800
Fan	Type		Propeller fan	Propeller fan	Propeller fan	Propeller fan
	Motor Output x Number	W x No.	900 x 2	900 x 2	(1,200 x 1) + (1,200 x 1)	(1,200 x 1) + (1,200 x 1)
	Air Flow Rate (High)	m ³ /min x No.	320 x 1	320 x 1	(240 x 1) + (240 x 1)	(240 x 1) + (240 x 1)
	Drive		DC INVERTER	DC INVERTER	DC INVERTER	DC INVERTER
	Discharge	Side / Top	TOP	TOP	TOP	TOP
Pipe Connections for Heat Recovery	Liquid Pipe	mm (inch)	Ø15.88 (5/8)	Ø19.05 (3/4)	Ø15.88 (5/8)	Ø15.88 (5/8)
	Low Pressure Gas Pipe	mm (inch)	Ø34.9 (1-3/8)	Ø34.9 (1-3/8)	Ø28.58 (1-1/8)	Ø34.9 (1-3/8)
	High Pressure Gas Pipe	mm (inch)	Ø28.58 (1-1/8)	Ø28.58 (1-1/8)	Ø28.58 (1-1/8)	Ø28.58 (1-1/8)
Pipe Connections for Heat Pump	Liquid Pipe	mm (inch)	Ø15.88 (5/8)	Ø19.05 (3/4)	Ø15.88 (5/8)	Ø15.88 (5/8)
	Gas Pipe	mm (inch)	Ø34.9 (1-3/8)	Ø34.9 (1-3/8)	Ø28.58 (1-1/8)	Ø34.9 (1-3/8)
Dimensions (W x H x D)	mm x No.	(1,240 x 1,690 x 760) x 1	(1,240 x 1,690 x 760) x 1	(930 x 1,690 x 760) x 1 + (930 x 1,690 x 760) x 1	(930 x 1,690 x 760) x 1 + (930 x 1,690 x 760) x 1	
Dimensions (W x H x D) - Shipping	mm x No.	(1,280 x 1,825 x 796) x 1	(1,280 x 1,825 x 796) x 1	(960 x 1,825 x 796) x 1 + (960 x 1,825 x 796) x 1	(960 x 1,825 x 796) x 1 + (960 x 1,825 x 796) x 1	
Net Weight	kg x No.	310 x 1	310 x 1	(215 x 1) + (215 x 1)	(215 x 1) + (215 x 1)	
Shipping Weight	kg x No.	320 x 1	320 x 1	(225 x 1) + (225 x 1)	(225 x 1) + (225 x 1)	
Sound Pressure Level	Cooling	dB(A)	65.0	65.0	61.5	62.0
	Heating	dB(A)	67.0	67.0	62.5	63.0
Sound Power Level	Cooling	dB(A)	91.0	91.0	83.1	84.0
	Heating	dB(A)	93.0	93.0	83.1	84.0
Communication Cable	mm ² x No. (VCTF-SB)		1.0 - 1.5 x 2C	1.0 - 1.5 x 2C	1.0 - 1.5 x 2C	1.0 - 1.5 x 2C
Refrigerant	Refrigerant Name		R410A	R410A	R410A	R410A
	Precharged Amount in Factory	kg	17.0	17.0	19.0	19.0
	t-CO ₂ eq		35.488	35.488	39.663	39.663
	Control		Electronic Expansion Valve	Electronic Expansion Valve	Electronic Expansion Valve	Electronic Expansion Valve
Power Supply	Ø, V, Hz		3, 380-415, 50	3, 380-415, 50	3, 380-415, 50	3, 380-415, 50
Number of Maximum Connectable Indoor Units ¹⁾			39 (61)	42 (64)	35 (44)	39 (48)

1) Maximum numbers are prepared based on assumption that all 2.2kW indoor units are connected. The numbers in parentheses means maximum connectable indoor units in accordance with outdoor units combination (160% - 200%). The recommended ratio is 130%.
2) Applying to 24 and 26HP outdoor units only.

ARUM261LTE5 / ARUM280LTE5
ARUM300LTE5 / ARUM320LTE5



HP			26'	28	30	32
Model Name	Combination Unit		ARUM261LTE5	ARUM280LTE5	ARUM300LTE5	ARUM320LTE5
	Independent Unit		ARUM140LTE5 ARUM120LTE5	ARUM160LTE5 ARUM120LTE5	ARUM180LTE5 ARUM120LTE5	ARUM200LTE5 ARUM120LTE5
Capacity	Cooling (Rated)	kW	72.8	78.4	84.0	89.6
	Heating (Rated)	kW	72.8	78.4	84.0	89.6
	Heating (Max)	kW	81.9	88.2	94.5	100.8
Input	Cooling (Rated)	kW	16.38	18.61	18.73	20.46
	Heating (Rated)	kW	15.33	17.13	16.97	19.05
	Heating (Max)	kW	17.98	20.65	20.20	22.95
EER		4.44	4.21	4.48	4.38	
SEER		-	-	-	-	
COP	Rated Capacity		4.75	4.58	4.95	4.70
	Max Capacity		4.56	4.27	4.68	4.39
SCOP		-	-	-	-	
Exterior	Color		Morning Gray / Dawn Gray	Morning Gray / Dawn Gray	Morning Gray / Dawn Gray	Morning Gray / Dawn Gray
	RAL Code (Classic)		RAL 7030 / RAL 7037	RAL 7030 / RAL 7037	RAL 7030 / RAL 7037	RAL 7030 / RAL 7037
Heat Exchanger	Type		Wide Louver Plus / Black Fin	Wide Louver Plus / Black Fin	Wide Louver Plus / Black Fin	Wide Louver Plus / Black Fin
	Type		Hermetically Sealed Scroll	Hermetically Sealed Scroll	Hermetically Sealed Scroll	Hermetically Sealed Scroll
Compressor	Combination x No.		(Inverter) x 2	(Inverter) x 2	(Inverter) x 3	(Inverter) x 3
	Motor Output x Number	W x No.	5,300 x 2	5,300 x 2	(5,300 x 2) + (4,200 x 1)	(5,300 x 2) + (4,200 x 1)
	Oil Type		FVC68D (PVE)	FVC68D (PVE)	FVC68D (PVE)	FVC68D (PVE)
	Oil Charge	cc	7,800	7,800	9,100	9,100
Fan	Type		Propeller fan	Propeller fan	Propeller fan	Propeller fan
	Motor Output x Number	W x No.	(900 x 2) + (1,200 x 1)	(900 x 2) + (1,200 x 1)	(900 x 2) + (1,200 x 1)	(900 x 2) + (1,200 x 1)
	Air Flow Rate (High)	m ³ /min x No.	(320 x 1) + (240 x 1)	(320 x 1) + (240 x 1)	(320 x 1) + (240 x 1)	(320 x 1) + (240 x 1)
	Drive		DC INVERTER	DC INVERTER	DC INVERTER	DC INVERTER
	Discharge	Side / Top	TOP	TOP	TOP	TOP
Pipe Connections for Heat Recovery	Liquid Pipe	mm (inch)	Ø19.05 (3/4)	Ø19.05 (3/4)	Ø19.05 (3/4)	Ø19.05 (3/4)
	Low Pressure Gas Pipe	mm (inch)	Ø34.9 (1-3/8)	Ø34.9 (1-3/8)	Ø34.9 (1-3/8)	Ø34.9 (1-3/8)
	High Pressure Gas Pipe	mm (inch)	Ø28.58 (1-1/8)	Ø28.58 (1-1/8)	Ø28.58 (1-1/8)	Ø28.58 (1-1/8)
Pipe Connections for Heat Pump	Liquid Pipe	mm (inch)	Ø19.05 (3/4)	Ø19.05 (3/4)	Ø19.05 (3/4)	Ø19.05 (3/4)
	Gas Pipe	mm (inch)	Ø34.9 (1-3/8)	Ø34.9 (1-3/8)	Ø34.9 (1-3/8)	Ø34.9 (1-3/8)
Dimensions (W x H x D)	mm x No.	(1,240 x 1,690 x 760) x 1 + (930 x 1,690 x 760) x 1	(1,240 x 1,690 x 760) x 1 + (930 x 1,690 x 760) x 1	(1,240 x 1,690 x 760) x 1 + (930 x 1,690 x 760) x 1	(1,240 x 1,690 x 760) x 1 + (930 x 1,690 x 760) x 1	
Dimensions (W x H x D) - Shipping	mm x No.	(1,280 x 1,825 x 796) x 1 + (960 x 1,825 x 796) x 1	(1,280 x 1,825 x 796) x 1 + (960 x 1,825 x 796) x 1	(1,280 x 1,825 x 796) x 1 + (960 x 1,825 x 796) x 1	(1,280 x 1,825 x 796) x 1 + (960 x 1,825 x 796) x 1	
Net Weight	kg x No.	(237 x 1) + (215 x 1)	(237 x 1) + (215 x 1)	(300 x 1) + (215 x 1)	(300 x 1) + (215 x 1)	
Shipping Weight	kg x No.	(250 x 1) + (225 x 1)	(250 x 1) + (225 x 1)	(312 x 1) + (225 x 1)	(312 x 1) + (225 x 1)	
Sound Pressure Level	Cooling	dB(A)	62.5	62.8	63.8	63.8
	Heating	dB(A)	63.5	63.8	64.1	65.8
Sound Power Level	Cooling	dB(A)	84.0	86.5	88.0	89.6
	Heating	dB(A)	84.5	87.2	88.0	90.5
Communication Cable	mm ² x No. (VCTF-SB)		1.0 - 1.5 x 2C	1.0 - 1.5 x 2C	1.0 - 1.5 x 2C	1.0 - 1.5 x 2C
Refrigerant	Refrigerant Name		R410A	R410A	R410A	R410A
	Precharged Amount in Factory	kg	23.0	23.0	25.5	25.5
	t-CO ₂ eq		48.013	48.013	53.231	53.231
	Control		Electronic Expansion Valve	Electronic Expansion Valve	Electronic Expansion Valve	Electronic Expansion Valve
Power Supply	Ø, V, Hz		3, 380-415, 50	3, 380-415, 50	3, 380-415, 50	3, 380-415, 50
Number of Maximum Connectable Indoor Units ¹⁾			42 (52)	45 (56)	49 (60)	52 (64)

1) Maximum numbers are prepared based on assumption that all 2.2kW indoor units are connected. The numbers in parentheses means maximum connectable indoor units in accordance with outdoor units combination (160% - 200%). The recommended ratio is 130%.

ARUM340LTE5 / ARUM360LTE5
ARUM380LTE5 / ARUM400LTE5



HP		34	36	38	40
Model Name	Combination Unit	ARUM340LTE5	ARUM360LTE5	ARUM380LTE5	ARUM400LTE5
	Independent Unit	ARUM220LTE5 ARUM120LTE5	ARUM240LTE5 ARUM120LTE5	ARUM240LTE5 ARUM140LTE5	ARUM240LTE5 ARUM160LTE5
Capacity	Cooling (Rated) kW	95.2	100.8	106.4	112.0
	Heating (Rated) kW	95.2	100.8	106.4	112.0
	Heating (Max) kW	107.1	112.1	118.4	124.7
Input	Cooling (Rated) kW	23.62	25.12	26.08	28.31
	Heating (Rated) kW	21.00	22.74	24.37	26.17
	Heating (Max) kW	25.02	27.06	28.52	31.19
EER		4.03	4.01	4.08	3.96
SEER		-	-	-	-
COP	Rated Capacity	4.53	4.43	4.37	4.28
	Max Capacity	4.28	4.14	4.15	4.00
SCOP		-	-	-	-
Exterior	Color	Morning Gray / Dawn Gray	Morning Gray / Dawn Gray	Morning Gray / Dawn Gray	Morning Gray / Dawn Gray
	RAL Code (Classic)	RAL 7030 / RAL 7037	RAL 7030 / RAL 7037	RAL 7030 / RAL 7037	RAL 7030 / RAL 7037
Heat Exchanger	Type	Wide Louver Plus / Black Fin	Wide Louver Plus / Black Fin	Wide Louver Plus / Black Fin	Wide Louver Plus / Black Fin
	Type	Hermetically Sealed Scroll	Hermetically Sealed Scroll	Hermetically Sealed Scroll	Hermetically Sealed Scroll
Compressor	Combination x No.	(Inverter) x 3	(Inverter) x 3	(Inverter) x 3	(Inverter) x 3
	Motor Output x Number	W x No. (5,300 x 2) + (4,200 x 1)	5,300 x 3	5,300 x 3	5,300 x 3
	Oil Type	FVC68D (PVE)	FVC68D (PVE)	FVC68D (PVE)	FVC68D (PVE)
	Oil Charge	cc	9,100	9,100	9,100
Fan	Type	Propeller fan	Propeller fan	Propeller fan	Propeller fan
	Motor Output x Number	W x No. (900 x 2) + (1,200 x 1)	(900 x 2) + (1,200 x 1)	900 x 4	900 x 4
	Air Flow Rate (High)	m ³ /min x No. (320 x 1) + (240 x 1)	(320 x 1) + (240 x 1)	320 x 2	320 x 2
	Drive	DC INVERTER	DC INVERTER	DC INVERTER	DC INVERTER
Pipe Connections for Heat Recovery	Liquid Pipe	mm (inch) Ø19.05 (3/4)	Ø19.05 (3/4)	Ø19.05 (3/4)	Ø19.05 (3/4)
	Low Pressure Gas Pipe	mm (inch) Ø34.9 (1-3/8)	Ø41.3 (1-5/8)	Ø41.3 (1-5/8)	Ø41.3 (1-5/8)
Pipe Connections for Heat Pump	Liquid Pipe	mm (inch) Ø19.05 (3/4)	Ø19.05 (3/4)	Ø19.05 (3/4)	Ø19.05 (3/4)
	Gas Pipe	mm (inch) Ø34.9 (1-3/8)	Ø41.3 (1-5/8)	Ø41.3 (1-5/8)	Ø41.3 (1-5/8)
Dimensions (W x H x D)	mm x No.	(1,240 x 1,690 x 760) x 1 + (930 x 1,690 x 760) x 1	(1,240 x 1,690 x 760) x 1 + (930 x 1,690 x 760) x 1	(1,240 x 1,690 x 760) x 2	(1,240 x 1,690 x 760) x 2
Dimensions (W x H x D) - Shipping	mm x No.	(1,280 x 1,825 x 796) x 1 + (960 x 1,825 x 796) x 1	(1,280 x 1,825 x 796) x 1 + (960 x 1,825 x 796) x 1	(1,280 x 1,825 x 796) x 2	(1,280 x 1,825 x 796) x 2
Net Weight	kg x No.	(300 x 1) + (215 x 1)	(310 x 1) + (215 x 1)	(310 x 1) + (237 x 1)	(310 x 1) + (237 x 1)
Shipping Weight	kg x No.	(312 x 1) + (225 x 1)	(320 x 1) + (225 x 1)	(320 x 1) + (250 x 1)	(320 x 1) + (250 x 1)
Sound Pressure Level	Cooling	dB(A) 65.6	66.0	66.2	66.3
	Heating	dB(A) 66.6	67.8	68.0	68.1
Sound Power Level	Cooling	dB(A) 91.4	91.4	91.4	92.0
	Heating	dB(A) 93.3	93.3	93.3	93.8
Communication Cable	mm ² x No. (VCTF-SB)	1.0 - 1.5 x 2C	1.0 - 1.5 x 2C	1.0 - 1.5 x 2C	1.0 - 1.5 x 2C
Refrigerant	Refrigerant Name	R410A	R410A	R410A	R410A
	Precharged Amount in Factory	kg	25.5	26.5	30.5
	t-CO ₂ eq		53.231	55.319	63.669
	Control		Electronic Expansion Valve	Electronic Expansion Valve	Electronic Expansion Valve
Power Supply	Ø, V, Hz	3, 380-415, 50	3, 380-415, 50	3, 380-415, 50	3, 380-415, 50
Number of Maximum Connectable Indoor Units ¹⁾		55 (64)	58 (64)	61 (64)	64

¹⁾ Maximum numbers are prepared based on assumption that all 2.2kW indoor units are connected. The numbers in parentheses means maximum connectable indoor units in accordance with outdoor units combination (160% - 200%). The recommended ratio is 130%.

ARUM420LTE5 / ARUM440LTE5
ARUM460LTE5 / ARUM480LTE5



HP		42	44	46	48
Model Name	Combination Unit	ARUM420LTE5	ARUM440LTE5	ARUM460LTE5	ARUM480LTE5
	Independent Unit	ARUM240LTE5 ARUM180LTE5	ARUM240LTE5 ARUM200LTE5	ARUM240LTE5 ARUM220LTE5	ARUM240LTE5 ARUM240LTE5
Capacity	Cooling (Rated) kW	117.6	123.2	128.8	134.4
	Heating (Rated) kW	117.6	123.2	128.8	134.4
	Heating (Max) kW	131.0	137.3	143.6	148.5
Input	Cooling (Rated) kW	28.44	30.17	33.33	34.82
	Heating (Rated) kW	26.01	28.09	30.04	31.78
	Heating (Max) kW	30.74	33.48	35.56	37.60
EER		4.14	4.08	3.86	3.86
SEER		-	-	-	-
COP	Rated Capacity	4.52	4.39	4.29	4.23
	Max Capacity	4.26	4.10	4.04	3.95
SCOP		-	-	-	-
Exterior	Color	Morning Gray / Dawn Gray	Morning Gray / Dawn Gray	Morning Gray / Dawn Gray	Morning Gray / Dawn Gray
	RAL Code (Classic)	RAL 7030 / RAL 7037	RAL 7030 / RAL 7037	RAL 7030 / RAL 7037	RAL 7030 / RAL 7037
Heat Exchanger	Type	Wide Louver Plus / Black Fin	Wide Louver Plus / Black Fin	Wide Louver Plus / Black Fin	Wide Louver Plus / Black Fin
	Type	Hermetically Sealed Scroll	Hermetically Sealed Scroll	Hermetically Sealed Scroll	Hermetically Sealed Scroll
Compressor	Combination x No.	(Inverter) x 4	(Inverter) x 4	(Inverter) x 4	(Inverter) x 4
	Motor Output x Number	W x No. (5,300 x 3) + (4,200 x 1)	(5,300 x 3) + (4,200 x 1)	(5,300 x 3) + (4,200 x 1)	5,300 x 4
	Oil Type	FVC68D (PVE)	FVC68D (PVE)	FVC68D (PVE)	FVC68D (PVE)
	Oil Charge	cc	10,400	10,400	10,400
Fan	Type	Propeller fan	Propeller fan	Propeller fan	Propeller fan
	Motor Output x Number	W x No. 900 x 4	900 x 4	900 x 4	900 x 4
	Air Flow Rate (High)	m ³ /min x No. 320 x 2	320 x 2	320 x 2	320 x 2
	Drive	DC INVERTER	DC INVERTER	DC INVERTER	DC INVERTER
Pipe Connections for Heat Recovery	Liquid Pipe	mm (inch) Ø19.05 (3/4)	Ø19.05 (3/4)	Ø19.05 (3/4)	Ø19.05 (3/4)
	Low Pressure Gas Pipe	mm (inch) Ø41.3 (1-5/8)	Ø41.3 (1-5/8)	Ø41.3 (1-5/8)	Ø41.3 (1-5/8)
Pipe Connections for Heat Pump	Liquid Pipe	mm (inch) Ø19.05 (3/4)	Ø19.05 (3/4)	Ø19.05 (3/4)	Ø19.05 (3/4)
	Gas Pipe	mm (inch) Ø41.3 (1-5/8)	Ø41.3 (1-5/8)	Ø41.3 (1-5/8)	Ø41.3 (1-5/8)
Dimensions (W x H x D)	mm x No.	(1,240 x 1,690 x 760) x 2	(1,240 x 1,690 x 760) x 2	(1,240 x 1,690 x 760) x 2	(1,240 x 1,690 x 760) x 2
Dimensions (W x H x D) - Shipping	mm x No.	(1,280 x 1,825 x 796) x 2	(1,280 x 1,825 x 796) x 2	(1,280 x 1,825 x 796) x 2	(1,280 x 1,825 x 796) x 2
Net Weight	kg x No.	(310 x 1) + (300 x 1)	(310 x 1) + (300 x 1)	(310 x 1) + (300 x 1)	310 x 2
Shipping Weight	kg x No.	(320 x 1) + (312 x 1)	(320 x 1) + (312 x 1)	(320 x 1) + (312 x 1)	320 x 2
Sound Pressure Level	Cooling	dB(A) 66.5	66.8	67.8	68.0
	Heating	dB(A) 68.2	68.9	69.3	70.0
Sound Power Level	Cooling	dB(A) 92.5	93.1	94.0	94.0
	Heating	dB(A) 94.0	94.8	96.0	96.0
Communication Cable	mm ² x No. (VCTF-SB)	1.0 - 1.5 x 2C	1.0 - 1.5 x 2C	1.0 - 1.5 x 2C	1.0 - 1.5 x 2C
Refrigerant	Refrigerant Name	R410A	R410A	R410A	R410A
	Precharged Amount in Factory	kg	33.0	33.0	34.0
	t-CO ₂ eq		68.888	68.888	70.975
	Control		Electronic Expansion Valve	Electronic Expansion Valve	Electronic Expansion Valve
Power Supply	Ø, V, Hz	3, 380-415, 50	3, 380-415, 50	3, 380-415, 50	3, 380-415, 50
Number of Maximum Connectable Indoor Units ¹⁾		64	64	64	64

¹⁾ Maximum numbers are prepared based on assumption that all 2.2kW indoor units are connected. The numbers in parentheses means maximum connectable indoor units in accordance with outdoor units combination (160% - 200%). The recommended ratio is 130%.

ARUM500LTE5 / ARUM520LTE5
ARUM540LTE5 / ARUM560LTE5



HP		50	52	54	56
Model Name	Combination Unit	ARUM500LTE5	ARUM520LTE5	ARUM540LTE5	ARUM560LTE5
	Independent Unit	ARUM240LTE5 ARUM140LTE5 ARUM120LTE5	ARUM240LTE5 ARUM160LTE5 ARUM120LTE5	ARUM240LTE5 ARUM180LTE5 ARUM120LTE5	ARUM240LTE5 ARUM200LTE5 ARUM120LTE5
Capacity	Cooling (Rated) kW	140	145.6	151.2	156.8
	Heating (Rated) kW	140	145.6	151.2	156.8
	Heating (Max) kW	156.2	162.5	168.8	175.1
Input	Cooling (Rated) kW	33.79	36.02	36.14	37.87
	Heating (Rated) kW	31.22	33.02	32.86	34.94
	Heating (Max) kW	36.78	39.45	39.00	41.74
EER		4.14	4.04	4.18	4.14
SEER		-	-	-	-
COP	Rated Capacity	4.48	4.41	4.60	4.49
	Max Capacity	4.25	4.12	4.33	4.19
SCOP		-	-	-	-
Exterior	Color	Morning Gray / Dawn Gray	Morning Gray / Dawn Gray	Morning Gray / Dawn Gray	Morning Gray / Dawn Gray
	RAL Code (Classic)	RAL 7030 / RAL 7037	RAL 7030 / RAL 7037	RAL 7030 / RAL 7037	RAL 7030 / RAL 7037
Heat Exchanger	Type	Wide Louver Plus / Black Fin	Wide Louver Plus / Black Fin	Wide Louver Plus / Black Fin	Wide Louver Plus / Black Fin
	Type	Hermetically Sealed Scroll	Hermetically Sealed Scroll	Hermetically Sealed Scroll	Hermetically Sealed Scroll
Compressor	Combination x No.	(Inverter) x 4	(Inverter) x 4	(Inverter) x 5	(Inverter) x 5
	Motor Output x Number	W x No. 5,300 x 4	5,300 x 4	(5,300 x 4) + (4,200 x 1)	(5,300 x 4) + (4,200 x 1)
	Oil Type	FVC68D (PVE)	FVC68D (PVE)	FVC68D (PVE)	FVC68D (PVE)
	Oil Charge	cc 13,000	13,000	14,300	14,300
Fan	Type	Propeller fan	Propeller fan	Propeller fan	Propeller fan
	Motor Output x Number	W x No. (900 x 4) + (1,200 x 1)	(900 x 4) + (1,200 x 1)	(900 x 4) + (1,200 x 1)	(900 x 4) + (1,200 x 1)
	Air Flow Rate (High)	m ³ /min x No. (320 x 2) + (240 x 1)	(320 x 2) + (240 x 1)	(320 x 2) + (240 x 1)	(320 x 2) + (240 x 1)
	Drive	DC INVERTER	DC INVERTER	DC INVERTER	DC INVERTER
Pipe Connections for Heat Recovery	Liquid Pipe	mm (inch) Ø19.05 (3/4)	Ø19.05 (3/4)	Ø19.05 (3/4)	Ø19.05 (3/4)
	Low Pressure Gas Pipe	mm (inch) Ø41.3 (1-5/8)	Ø41.3 (1-5/8)	Ø41.3 (1-5/8)	Ø41.3 (1-5/8)
Pipe Connections for Heat Pump	Liquid Pipe	mm (inch) Ø19.05 (3/4)	Ø19.05 (3/4)	Ø19.05 (3/4)	Ø19.05 (3/4)
	Gas Pipe	mm (inch) Ø41.3 (1-5/8)	Ø41.3 (1-5/8)	Ø41.3 (1-5/8)	Ø41.3 (1-5/8)
Dimensions (W x H x D)	mm x No.	(1,240 x 1,690 x 760) x 2 + (930 x 1,690 x 760) x 1	(1,240 x 1,690 x 760) x 2 + (930 x 1,690 x 760) x 1	(1,240 x 1,690 x 760) x 2 + (930 x 1,690 x 760) x 1	(1,240 x 1,690 x 760) x 2 + (930 x 1,690 x 760) x 1
Dimensions (W x H x D) - Shipping	mm x No.	(1,280 x 1,825 x 796) x 2 + (960 x 1,825 x 796) x 1	(1,280 x 1,825 x 796) x 2 + (960 x 1,825 x 796) x 1	(1,280 x 1,825 x 796) x 2 + (960 x 1,825 x 796) x 1	(1,280 x 1,825 x 796) x 2 + (960 x 1,825 x 796) x 1
Net Weight	kg x No.	(310 x 1) + (237 x 1) + (215 x 1)	(310 x 1) + (237 x 1) + (215 x 1)	(310 x 1) + (300 x 1) + (215 x 1)	(310 x 1) + (300 x 1) + (215 x 1)
Shipping Weight	kg x No.	(320 x 1) + (250 x 1) + (225 x 1)	(320 x 1) + (250 x 1) + (225 x 1)	(320 x 1) + (312 x 1) + (225 x 1)	(320 x 1) + (312 x 1) + (225 x 1)
Sound Pressure Level	Cooling	dB(A) 67.0	67.1	67.2	67.4
	Heating	68.6	68.7	68.8	69.5
Sound Power Level	Cooling	dB(A) 91.8	92.3	92.8	93.4
	Heating	93.6	94.0	94.2	94.9
Communication Cable	mm ² x No. (VCTF-SB)	1.0 - 1.5 x 2C	1.0 - 1.5 x 2C	1.0 - 1.5 x 2C	1.0 - 1.5 x 2C
Refrigerant	Refrigerant Name	R410A	R410A	R410A	R410A
	Precharged Amount in Factory	kg 40	40	42.5	42.5
	t-CO ₂ eq	83.500	83.500	88.719	88.719
Control		Electronic Expansion Valve	Electronic Expansion Valve	Electronic Expansion Valve	Electronic Expansion Valve
Power Supply	Ø, V, Hz	3, 380-415, 50	3, 380-415, 50	3, 380-415, 50	3, 380-415, 50
Number of Maximum Connectable Indoor Units ¹⁾		64	64	64	64

¹⁾ Maximum numbers are prepared based on assumption that all 2.2kW indoor units are connected. The numbers in parentheses means maximum connectable indoor units in accordance with outdoor units combination (160% - 200%). The recommended ratio is 130%.

ARUM580LTE5 / ARUM600LTE5 / ARUM620LTE5
ARUM640LTE5 / ARUM660LTE5



HP		58	60	62	64	66
Model Name	Combination Unit	ARUM580LTE5	ARUM600LTE5	ARUM620LTE5	ARUM640LTE5	ARUM660LTE5
	Independent Unit	ARUM240LTE5 ARUM220LTE5 ARUM120LTE5	ARUM240LTE5 ARUM240LTE5 ARUM120LTE5	ARUM240LTE5 ARUM240LTE5 ARUM140LTE5	ARUM240LTE5 ARUM240LTE5 ARUM160LTE5	ARUM240LTE5 ARUM240LTE5 ARUM180LTE5
Capacity	Cooling (Rated) kW	162.4	168.0	173.6	179.2	184.8
	Heating (Rated) kW	162.4	168.0	173.6	179.2	184.8
	Heating (Max) kW	181.4	186.3	192.6	198.9	205.2
Input	Cooling (Rated) kW	41.03	42.53	43.49	45.72	45.85
	Heating (Rated) kW	36.89	38.63	40.26	42.06	41.90
	Heating (Max) kW	43.82	45.86	47.32	49.99	49.54
EER		3.96	3.95	3.99	3.92	4.03
SEER		-	-	-	-	-
COP	Rated Capacity	4.40	4.35	4.31	4.26	4.41
	Max Capacity	4.14	4.06	4.07	3.98	4.14
SCOP		-	-	-	-	-
Exterior	Color	Morning Gray / Dawn Gray	Morning Gray / Dawn Gray	Morning Gray / Dawn Gray	Morning Gray / Dawn Gray	Morning Gray / Dawn Gray
	RAL Code (Classic)	RAL 7030 / RAL 7037	RAL 7030 / RAL 7037	RAL 7030 / RAL 7037	RAL 7030 / RAL 7037	RAL 7030 / RAL 7037
Heat Exchanger	Type	Wide Louver Plus / Black Fin	Wide Louver Plus / Black Fin	Wide Louver Plus / Black Fin	Wide Louver Plus / Black Fin	Wide Louver Plus / Black Fin
	Type	Hermetically Sealed Scroll	Hermetically Sealed Scroll	Hermetically Sealed Scroll	Hermetically Sealed Scroll	Hermetically Sealed Scroll
Compressor	Combination x No.	(Inverter) x 5	(Inverter) x 5	(Inverter) x 5	(Inverter) x 5	(Inverter) x 6
	Motor Output x Number	W x No. (5,300 x 4) + (4,200 x 1)	5,300 x 5	5,300 x 5	5,300 x 5	(5,300 x 5) + (4,200 x 1)
	Oil Type	FVC68D (PVE)	FVC68D (PVE)	FVC68D (PVE)	FVC68D (PVE)	FVC68D (PVE)
	Oil Charge	cc 14,300	14,300	14,300	14,300	15,600
Fan	Type	Propeller fan	Propeller fan	Propeller fan	Propeller fan	Propeller fan
	Motor Output x Number	W x No. (900 x 4) + (1,200 x 1)	(900 x 4) + (1,200 x 1)	900 x 6	900 x 6	900 x 6
	Air Flow Rate (High)	m ³ /min x No. (320 x 2) + (240 x 1)	(320 x 2) + (240 x 1)	320 x 3	320 x 3	320 x 3
	Drive	DC INVERTER	DC INVERTER	DC INVERTER	DC INVERTER	DC INVERTER
Pipe Connections for Heat Recovery	Liquid Pipe	mm (inch) Ø19.05 (3/4)	Ø19.05 (3/4)	Ø22.2 (7/8)	Ø22.2 (7/8)	Ø22.2 (7/8)
	Low Pressure Gas Pipe	mm (inch) Ø41.3 (1-5/8)	Ø41.3 (1-5/8)	Ø44.5 (1-3/4)	Ø44.5 (1-3/4)	Ø53.98 (2-1/8)
Pipe Connections for Heat Pump	Liquid Pipe	mm (inch) Ø19.05 (3/4)	Ø19.05 (3/4)	Ø22.2 (7/8)	Ø22.2 (7/8)	Ø22.2 (7/8)
	Gas Pipe	mm (inch) Ø41.3 (1-5/8)	Ø41.3 (1-5/8)	Ø44.5 (1-3/4)	Ø44.5 (1-3/4)	Ø53.98 (2-1/8)
Dimensions (W x H x D)	mm x No.	(1,240 x 1,690 x 760) x 2 + (930 x 1,690 x 760) x 1	(1,240 x 1,690 x 760) x 2 + (930 x 1,690 x 760) x 1	(1,240 x 1,690 x 760) x 3	(1,240 x 1,690 x 760) x 3	(1,240 x 1,690 x 760) x 3
Dimensions (W x H x D) - Shipping	mm x No.	(1,280 x 1,825 x 796) x 2 + (960 x 1,825 x 796) x 1	(1,280 x 1,825 x 796) x 2 + (960 x 1,825 x 796) x 1	(1,280 x 1,825 x 796) x 3	(1,280 x 1,825 x 796) x 3	(1,280 x 1,825 x 796) x 3
Net Weight	kg x No.	(310 x 1) + (300 x 1) + (215 x 1)	(310 x 2) + (215 x 1)	(310 x 2) + (237 x 1)	(310 x 2) + (237 x 1)	(310 x 2) + (300 x 1)
Shipping Weight	kg x No.	(320 x 1) + (312 x 1) + (225 x 1)	(320 x 2) + (225 x 1)	(320 x 2) + (250 x 1)	(320 x 2) + (250 x 1)	(320 x 2) + (312 x 1)
Sound Pressure Level	Cooling	dB(A) 68.3	68.5	68.6	68.7	68.8
	Heating	69.8	70.4	70.5	70.6	70.6
Sound Power Level	Cooling	dB(A) 94.2	94.2	94.2	94.5	94.8
	Heating	96.1	96.1	96.2	96.4	96.5
Communication Cable	mm ² x No. (VCTF-SB)	1.0 - 1.5 x 2C	1.0 - 1.5 x 2C	1.0 - 1.5 x 2C	1.0 - 1.5 x 2C	1.0 - 1.5 x 2C
Refrigerant	Refrigerant Name	R410A	R410A	R410A	R410A	R410A
	Precharged Amount in Factory	kg 42.5	43.5	47.5	47.5	50.0
	t-CO ₂ eq	88.719	90.806	99.156	99.156	104.375
Control		Electronic Expansion Valve	Electronic Expansion Valve	Electronic Expansion Valve	Electronic Expansion Valve	Electronic Expansion Valve
Power Supply	Ø, V, Hz	3, 380-415, 50	3, 380-415, 50	3, 380-415, 50	3, 380-415, 50	3, 380-415, 50
Number of Maximum Connectable Indoor Units ¹⁾		64	64	64	64	64

¹⁾ Maximum numbers are prepared based on assumption that all 2.2kW indoor units are connected. The numbers in parentheses means maximum connectable indoor units in accordance with outdoor units combination (160% - 200%). The recommended ratio is 130%.

ARUM680LTE5 / ARUM700LTE5 / ARUM720LTE5
ARUM740LTE5 / ARUM760LTE5



HP			68	70	72	74	76
Model Name	Combination Unit		ARUM680LTE5	ARUM700LTE5	ARUM720LTE5	ARUM740LTE5	ARUM760LTE5
	Independent Unit		ARUM240LTE5 ARUM240LTE5 ARUM200LTE5	ARUM240LTE5 ARUM240LTE5 ARUM220LTE5	ARUM240LTE5 ARUM240LTE5 ARUM240LTE5	ARUM240LTE5 ARUM240LTE5 ARUM140LTE5 ARUM120LTE5	ARUM240LTE5 ARUM240LTE5 ARUM160LTE5 ARUM140LTE5
Capacity	Cooling (Rated)	kW	190.4	196.0	201.6	207.2	212.8
	Heating (Rated)	kW	190.4	196.0	201.6	207.2	212.8
	Heating (Max)	kW	211.5	217.8	222.8	230.4	236.7
Input	Cooling (Rated)	kW	47.57	50.74	52.23	51.20	53.43
	Heating (Rated)	kW	43.98	45.93	47.67	47.11	48.91
	Heating (Max)	kW	52.28	54.36	56.40	55.58	58.25
EER		4.00	3.86	3.86	4.05	3.98	
SEER		-	-	-	-	-	
COP	Rated Capacity		4.33	4.27	4.23	4.40	4.35
	Max Capacity		4.05	4.01	3.95	4.15	4.06
SCOP		-	-	-	-	-	
Exterior	Color		Morning Gray / Dawn Gray	Morning Gray / Dawn Gray	Morning Gray / Dawn Gray	Morning Gray / Dawn Gray	Morning Gray / Dawn Gray
	RAL Code (Classic)		RAL 7030 / RAL 7037	RAL 7030 / RAL 7037	RAL 7030 / RAL 7037	RAL 7030 / RAL 7037	RAL 7030 / RAL 7037
Heat Exchanger	Type		Wide Louver Plus / Black Fin	Wide Louver Plus / Black Fin	Wide Louver Plus / Black Fin	Wide Louver Plus / Black Fin	Wide Louver Plus / Black Fin
	Type		Hermetically Sealed Scroll	Hermetically Sealed Scroll	Hermetically Sealed Scroll	Hermetically Sealed Scroll	Hermetically Sealed Scroll
Compressor	Combination x No.		(Inverter) x 6	(Inverter) x 6	(Inverter) x 6	(Inverter) x 6	(Inverter) x 6
	Motor Output x Number	W x No.	(5,300 x 5) + (4,200 x 1)	(5,300 x 5) + (4,200 x 1)	5,300 x 6	5,300 x 6	5,300 x 6
	Oil Type		FVC68D (PVE)	FVC68D (PVE)	FVC68D (PVE)	FVC68D (PVE)	FVC68D (PVE)
	Oil Charge	cc	15,600	15,600	15,600	18,200	18,200
	Type		Propeller fan	Propeller fan	Propeller fan	Propeller fan	Propeller fan
Fan	Motor Output x Number	W x No.	900 x 6	900 x 6	900 x 6	(900 x 6) + (1,200 x 1)	(900 x 6) + (1,200 x 1)
	Air Flow Rate (High)	m³/min x No.	320 x 3	320 x 3	320 x 3	(320 x 3) + (240 x 1)	(320 x 3) + (240 x 1)
	Drive		DC INVERTER	DC INVERTER	DC INVERTER	DC INVERTER	DC INVERTER
Pipe Connections for Heat Recovery	Liquid Pipe	mm (inch)	Ø22.2 (7/8)	Ø22.2 (7/8)	Ø22.2 (7/8)	Ø22.2 (7/8)	Ø22.2 (7/8)
	Low Pressure Gas Pipe	mm (inch)	Ø53.98 (2-1/8)	Ø53.98 (2-1/8)	Ø53.98 (2-1/8)	Ø53.98 (2-1/8)	Ø53.98 (2-1/8)
	High Pressure Gas Pipe	mm (inch)	Ø44.5 (1-3/4)	Ø44.5 (1-3/4)	Ø44.5 (1-3/4)	Ø44.5 (1-3/4)	Ø44.5 (1-3/4)
Pipe Connections for Heat Pump	Liquid Pipe	mm (inch)	Ø22.2 (7/8)	Ø22.2 (7/8)	Ø22.2 (7/8)	Ø22.2 (7/8)	Ø22.2 (7/8)
	Gas Pipe	mm (inch)	Ø53.98 (2-1/8)	Ø53.98 (2-1/8)	Ø53.98 (2-1/8)	Ø53.98 (2-1/8)	Ø53.98 (2-1/8)
Dimensions (W x H x D)	mm x No.	(1,240 x 1,690 x 760) x 3	(1,240 x 1,690 x 760) x 3	(1,240 x 1,690 x 760) x 3	(1,240 x 1,690 x 760) x 3 + (930 x 1,690 x 760) x 1	(1,240 x 1,690 x 760) x 3 + (930 x 1,690 x 760) x 1	
Dimensions (W x H x D) - Shipping	mm x No.	(1,280 x 1,825 x 796) x 3	(1,280 x 1,825 x 796) x 3	(1,280 x 1,825 x 796) x 3	(1,280 x 1,825 x 796) x 3 + (960 x 1,825 x 796) x 1	(1,280 x 1,825 x 796) x 3 + (960 x 1,825 x 796) x 1	
Net Weight	kg x No.	(310 x 2) + (300 x 1)	(310 x 2) + (300 x 1)	310 x 3	(310 x 2) + (237 x 1) + (215 x 1)	(310 x 2) + (237 x 1) + (215 x 1)	
Shipping Weight	kg x No.	(320 x 2) + (312 x 1)	(320 x 2) + (312 x 1)	320 x 3	(320 x 2) + (250 x 1) + (225 x 1)	(320 x 2) + (250 x 1) + (225 x 1)	
Sound Pressure Level	Cooling	dB(A)	69.0	69.6	69.8	69.1	69.2
	Heating	dB(A)	71.1	71.3	71.8	70.9	70.9
Sound Power Level	Cooling	dB(A)	95.2	95.8	95.8	94.4	94.7
	Heating	dB(A)	97.0	97.8	97.8	96.3	96.5
Communication Cable	mm² x No. (VCTF-SB)		1.0 - 1.5 x 2C	1.0 - 1.5 x 2C	1.0 - 1.5 x 2C	1.0 - 1.5 x 2C	1.0 - 1.5 x 2C
Refrigerant	Refrigerant Name		R410A	R410A	R410A	R410A	R410A
	Precharged Amount in Factory	kg	50.0	50.0	51.0	57.0	57.0
	t-CO ₂ eq		104.375	104.375	106.463	118.988	118.988
Power Supply	Control		Electronic Expansion Valve	Electronic Expansion Valve	Electronic Expansion Valve	Electronic Expansion Valve	Electronic Expansion Valve
	Ø, V, Hz		3, 380-415, 50	3, 380-415, 50	3, 380-415, 50	3, 380-415, 50	3, 380-415, 50
Number of Maximum Connectable Indoor Units ¹⁾		64	64	64	64	64	

1) Maximum numbers are prepared based on assumption that all 2.2kW indoor units are connected. The numbers in parentheses means maximum connectable indoor units in accordance with outdoor units combination (160% - 200%). The recommended ratio is 130%.

ARUM780LTE5 / ARUM800LTE5 / ARUM820LTE5
ARUM840LTE5 / ARUM860LTE5



HP			78	80	82	84	86
Model Name	Combination Unit		ARUM780LTE5	ARUM800LTE5	ARUM820LTE5	ARUM840LTE5	ARUM860LTE5
	Independent Unit		ARUM240LTE5 ARUM240LTE5 ARUM180LTE5 ARUM120LTE5	ARUM240LTE5 ARUM240LTE5 ARUM200LTE5 ARUM120LTE5	ARUM240LTE5 ARUM240LTE5 ARUM220LTE5 ARUM120LTE5	ARUM240LTE5 ARUM240LTE5 ARUM240LTE5 ARUM120LTE5	ARUM240LTE5 ARUM240LTE5 ARUM240LTE5 ARUM140LTE5
Capacity	Cooling (Rated)	kW	218.4	224.0	229.6	235.2	240.8
	Heating (Rated)	kW	218.4	224.0	229.6	235.2	240.8
	Heating (Max)	kW	243.0	249.3	255.6	260.6	266.9
Input	Cooling (Rated)	kW	53.55	55.28	58.44	59.93	60.90
	Heating (Rated)	kW	48.75	50.83	52.78	54.52	56.15
	Heating (Max)	kW	57.80	60.54	62.62	64.66	66.12
EER		4.08	4.05	3.93	3.92	3.95	
SEER		-	-	-	-	-	
COP	Rated Capacity		4.48	4.41	4.35	4.31	4.29
	Max Capacity		4.20	4.12	4.08	4.03	4.04
SCOP		-	-	-	-	-	
Exterior	Color		Morning Gray / Dawn Gray	Morning Gray / Dawn Gray	Morning Gray / Dawn Gray	Morning Gray / Dawn Gray	Morning Gray / Dawn Gray
	RAL Code (Classic)		RAL 7030 / RAL 7037	RAL 7030 / RAL 7037	RAL 7030 / RAL 7037	RAL 7030 / RAL 7037	RAL 7030 / RAL 7037
Heat Exchanger	Type		Wide Louver Plus / Black Fin	Wide Louver Plus / Black Fin	Wide Louver Plus / Black Fin	Wide Louver Plus / Black Fin	Wide Louver Plus / Black Fin
	Type		Hermetically Sealed Scroll	Hermetically Sealed Scroll	Hermetically Sealed Scroll	Hermetically Sealed Scroll	Hermetically Sealed Scroll
Compressor	Combination x No.		(Inverter) x 7	(Inverter) x 7	(Inverter) x 7	(Inverter) x 7	(Inverter) x 7
	Motor Output x Number	W x No.	(5,300 x 6) + (4,200 x 1)	(5,300 x 6) + (4,200 x 1)	(5,300 x 6) + (4,200 x 1)	5,300 x 7	5,300 x 7
	Oil Type		FVC68D (PVE)	FVC68D (PVE)	FVC68D (PVE)	FVC68D (PVE)	FVC68D (PVE)
	Oil Charge	cc	19,500	19,500	19,500	19,500	19,500
	Type		Propeller fan	Propeller fan	Propeller fan	Propeller fan	Propeller fan
Fan	Motor Output x Number	W x No.	(900 x 6) + (1,200 x 1)	(900 x 6) + (1,200 x 1)	(900 x 6) + (1,200 x 1)	(900 x 6) + (1,200 x 1)	900 x 8
	Air Flow Rate (High)	m³/min x No.	(320 x 3) + (240 x 1)	(320 x 3) + (240 x 1)	(320 x 3) + (240 x 1)	(320 x 3) + (240 x 1)	320 x 4
	Drive		DC INVERTER	DC INVERTER	DC INVERTER	DC INVERTER	DC INVERTER
Pipe Connections for Heat Recovery	Liquid Pipe	mm (inch)	Ø22.2 (7/8)	Ø22.2 (7/8)	Ø22.2 (7/8)	Ø22.2 (7/8)	Ø22.2 (7/8)
	Low Pressure Gas Pipe	mm (inch)	Ø53.98 (2-1/8)	Ø53.98 (2-1/8)	Ø53.98 (2-1/8)	Ø53.98 (2-1/8)	Ø53.98 (2-1/8)
	High Pressure Gas Pipe	mm (inch)	Ø44.5 (1-3/4)	Ø44.5 (1-3/4)	Ø44.5 (1-3/4)	Ø44.5 (1-3/4)	Ø44.5 (1-3/4)
Pipe Connections for Heat Pump	Liquid Pipe	mm (inch)	Ø22.2 (7/8)	Ø22.2 (7/8)	Ø22.2 (7/8)	Ø22.2 (7/8)	Ø22.2 (7/8)
	Gas Pipe	mm (inch)	Ø53.98 (2-1/8)	Ø53.98 (2-1/8)	Ø53.98 (2-1/8)	Ø53.98 (2-1/8)	Ø53.98 (2-1/8)
Dimensions (W x H x D)	mm x No.	(1,240 x 1,690 x 760) x 3 + (930 x 1,690 x 760) x 1	(1,240 x 1,690 x 760) x 3 + (930 x 1,690 x 760) x 1	(1,240 x 1,690 x 760) x 3 + (930 x 1,690 x 760) x 1	(1,240 x 1,690 x 760) x 3 + (930 x 1,690 x 760) x 1	(1,240 x 1,690 x 760) x 3 + (930 x 1,690 x 760) x 1	
Dimensions (W x H x D) - Shipping	mm x No.	(1,280 x 1,825 x 796) x 3 + (960 x 1,825 x 796) x 1	(1,280 x 1,825 x 796) x 3 + (960 x 1,825 x 796) x 1	(1,280 x 1,825 x 796) x 3 + (960 x 1,825 x 796) x 1	(1,280 x 1,825 x 796) x 3 + (960 x 1,825 x 796) x 1	(1,280 x 1,825 x 796) x 3 + (960 x 1,825 x 796) x 1	
Net Weight	kg x No.	(310 x 2) + (300 x 1) + (215 x 1)	(310 x 2) + (300 x 1) + (215 x 1)	(310 x 2) + (300 x 1) + (215 x 1)	(310 x 2) + (300 x 1) + (215 x 1)	(310 x 2) + (300 x 1) + (215 x 1)	
Shipping Weight	kg x No.	(320 x 2) + (312 x 1) + (225 x 1)	(320 x 2) + (312 x 1) + (225 x 1)	(320 x 2) + (312 x 1) + (225 x 1)	(320 x 2) + (312 x 1) + (225 x 1)	(320 x 2) + (312 x 1) + (225 x 1)	
Sound Pressure Level	Cooling	dB(A)	69.2	69.4	70.0	70.1	70.2
	Heating	dB(A)	71.0	71.4	71.6	72.1	72.1
Sound Power Level	Cooling	dB(A)	95.0	95.4	95.9	95.9	95.9
	Heating	dB(A)	96.6	97.1	97.9	97.9	97.9
Communication Cable	mm² x No. (VCTF-SB)		1.0 - 1.5 x 2C	1.0 - 1.5 x 2C	1.0 - 1.5 x 2C	1.0 - 1.5 x 2C	1.0 - 1.5 x 2C
Refrigerant	Refrigerant Name		R410A	R410A	R410A	R410A	R410A
	Precharged Amount in Factory	kg	59.5	59.5	59.5	60.5	64.5
	t-CO ₂ eq		124.206	124.206	124.206	126.294	134.644
Power Supply	Control		Electronic Expansion Valve	Electronic Expansion Valve	Electronic Expansion Valve	Electronic Expansion Valve	Electronic Expansion Valve
	Ø, V, Hz		3, 380-415, 50	3, 380-415, 50	3, 380-415, 50	3, 380-415, 50	3, 380-415, 50
Number of Maximum Connectable Indoor Units ¹⁾		64	64	64	64	64	

1) Maximum numbers are prepared based on assumption that all 2.2kW indoor units are connected. The numbers in parentheses means maximum connectable indoor units in accordance with outdoor units combination (160% - 200%). The recommended ratio is 130%.

ARUM880LTE5 / ARUM900LTE5 / ARUM920LTE5
ARUM940LTE5 / ARUM960LTE5



HP		88	90	92	94	96	
Model Name	Combination Unit	ARUM880LTE5	ARUM900LTE5	ARUM920LTE5	ARUM940LTE5	ARUM960LTE5	
	Independent Unit	ARUM240LTE5 ARUM240LTE5 ARUM240LTE5 ARUM160LTE5	ARUM240LTE5 ARUM240LTE5 ARUM180LTE5	ARUM240LTE5 ARUM240LTE5 ARUM240LTE5 ARUM200LTE5	ARUM240LTE5 ARUM240LTE5 ARUM240LTE5 ARUM220LTE5	ARUM240LTE5 ARUM240LTE5 ARUM240LTE5 ARUM240LTE5	
Capacity	Cooling (Rated) kW	246.4	252.0	257.6	263.2	268.8	
	Heating (Rated) kW	246.4	252.0	257.6	263.2	268.8	
	Heating (Max) kW	273.2	279.5	285.8	292.1	297.0	
Input	Cooling (Rated) kW	63.13	63.26	64.98	68.15	69.64	
	Heating (Rated) kW	57.95	57.79	59.87	61.82	63.56	
	Heating (Max) kW	68.79	68.34	71.08	73.16	75.19	
EER		3.90	3.98	3.96	3.86	3.86	
SEER		-	-	-	-	-	
COP	Rated Capacity	4.25	4.36	4.30	4.26	4.23	
	Max Capacity	3.97	4.09	4.02	3.99	3.95	
SCOP		-	-	-	-	-	
Exterior	Color	Morning Gray / Dawn Gray	Morning Gray / Dawn Gray	Morning Gray / Dawn Gray	Morning Gray / Dawn Gray	Morning Gray / Dawn Gray	
	RAL Code (Classic)	RAL 7030 / RAL 7037	RAL 7030 / RAL 7037	RAL 7030 / RAL 7037	RAL 7030 / RAL 7037	RAL 7030 / RAL 7037	
Heat Exchanger	Type	Wide Louver Plus / Black Fin	Wide Louver Plus / Black Fin	Wide Louver Plus / Black Fin	Wide Louver Plus / Black Fin	Wide Louver Plus / Black Fin	
	Type	Hermetically Sealed Scroll	Hermetically Sealed Scroll	Hermetically Sealed Scroll	Hermetically Sealed Scroll	Hermetically Sealed Scroll	
Compressor	Combination x No.	(Inverter) x 7	(Inverter) x 8	(Inverter) x 8	(Inverter) x 8	(Inverter) x 8	
	Motor Output x Number	W x No.	5,300 x 7	(5,300 x 7) + (4,200 x 1)	(5,300 x 7) + (4,200 x 1)	(5,300 x 7) + (4,200 x 1)	5,300 x 8
	Oil Type	FVC68D (PVE)	FVC68D (PVE)	FVC68D (PVE)	FVC68D (PVE)	FVC68D (PVE)	
	Oil Charge cc	19,500	20,800	20,800	20,800	20,800	
Fan	Type	Propeller fan	Propeller fan	Propeller fan	Propeller fan	Propeller fan	
	Motor Output x Number	W x No.	900 x 8	900 x 8	900 x 8	900 x 8	
	Air Flow Rate (High)	m³/min x No.	320 x 4	320 x 4	320 x 4	320 x 4	320 x 4
	Drive	DC INVERTER	DC INVERTER	DC INVERTER	DC INVERTER	DC INVERTER	
Pipe Connections for Heat Recovery	Liquid Pipe	mm (inch)	Ø22.2 (7/8)	Ø22.2 (7/8)	Ø22.2 (7/8)	Ø22.2 (7/8)	
	Low Pressure Gas Pipe	mm (inch)	Ø53.98 (2-1/8)	Ø53.98 (2-1/8)	Ø53.98 (2-1/8)	Ø53.98 (2-1/8)	
Pipe Connections for Heat Pump	High Pressure Gas Pipe	mm (inch)	Ø44.5 (1-3/4)	Ø44.5 (1-3/4)	Ø44.5 (1-3/4)	Ø44.5 (1-3/4)	
	Liquid Pipe	mm (inch)	Ø22.2 (7/8)	Ø22.2 (7/8)	Ø22.2 (7/8)	Ø22.2 (7/8)	
Dimensions (W x H x D)	Gas Pipe	mm (inch)	Ø53.98 (2-1/8)	Ø53.98 (2-1/8)	Ø53.98 (2-1/8)	Ø53.98 (2-1/8)	
	mm x No.	(1,240 x 1,690 x 760) x 4	(1,240 x 1,690 x 760) x 4	(1,240 x 1,690 x 760) x 4	(1,240 x 1,690 x 760) x 4	(1,240 x 1,690 x 760) x 4	
Dimensions (W x H x D) - Shipping	mm x No.	(1,280 x 1,825 x 796) x 4	(1,280 x 1,825 x 796) x 4	(1,280 x 1,825 x 796) x 4	(1,280 x 1,825 x 796) x 4	(1,280 x 1,825 x 796) x 4	
	kg x No.	(310 x 3) + (237 x 1)	(310 x 3) + (300 x 1)	(310 x 3) + (300 x 1)	(310 x 3) + (300 x 1)	310 x 4	
Shipping Weight	kg x No.	(320 x 3) + (250 x 1)	(320 x 3) + (312 x 1)	(320 x 3) + (312 x 1)	(320 x 3) + (312 x 1)	320 x 4	
	kg x No.	(320 x 3) + (250 x 1)	(320 x 3) + (312 x 1)	(320 x 3) + (312 x 1)	(320 x 3) + (312 x 1)	320 x 4	
Sound Pressure Level	Cooling dB(A)	70.3	70.3	70.4	70.9	71.0	
	Heating dB(A)	72.2	72.2	72.5	72.7	73.0	
Sound Power Level	Cooling dB(A)	96.1	96.3	96.6	97.0	97.0	
	Heating dB(A)	98.1	98.1	98.4	99.0	99.0	
Communication Cable	mm² x No. (VCTF-SB)	1.0 - 1.5 x 2C	1.0 - 1.5 x 2C	1.0 - 1.5 x 2C	1.0 - 1.5 x 2C	1.0 - 1.5 x 2C	
	mm² x No. (VCTF-SB)	1.0 - 1.5 x 2C	1.0 - 1.5 x 2C	1.0 - 1.5 x 2C	1.0 - 1.5 x 2C	1.0 - 1.5 x 2C	
Refrigerant	Refrigerant Name	R410A	R410A	R410A	R410A	R410A	
	Precharged Amount in Factory	kg	64.5	67.0	67.0	68.0	
	t-CO ₂ eq	134.644	139.863	139.863	139.863	141.950	
	Control	Electronic Expansion Valve	Electronic Expansion Valve	Electronic Expansion Valve	Electronic Expansion Valve	Electronic Expansion Valve	
Power Supply	Ø, V, Hz	3, 380-415, 50	3, 380-415, 50	3, 380-415, 50	3, 380-415, 50	3, 380-415, 50	
Number of Maximum Connectable Indoor Units ¹⁾		64	64	64	64	64	

1) Maximum numbers are prepared based on assumption that all 2.2kW indoor units are connected. The numbers in parentheses means maximum connectable indoor units in accordance with outdoor units combination (160% - 200%). The recommended ratio is 130%.

1. Eurovent Test Condition : For more info regarding program consult www.eurovent-certification.com

2. Capacities are based on the following conditions :

- Cooling Temperature : Indoor 27°C (80.6°F) DB / 19°C (66.2°F) WB Outdoor 35°C (95°F) DB / 24°C (75.2°F) WB
- Heating Temperature : Indoor 20°C (68°F) DB / 15°C (59°F) WB Outdoor 7°C (44.6°F) DB / 6°C (42.8°F) WB
- Piping Length : Interconnected Pipe Length = 7.5m
- Difference Limit of Elevation (Outdoor - Indoor Unit) is 0m.

3. Wiring cable size must comply with the applicable local and national code.

4. Sound pressure level is measured on the rated condition in the anechoic rooms by ISO 3745 standard. Sound power level is measured on the rated condition in the reverberation rooms by ISO 3741 standard. Therefore, these values can be increased owing to ambient conditions during operation.

5. Explanation of Terms

- EER : Energy Efficiency Ratio (Cooling)
- SEER : Seasonal Energy Efficiency Ratio (Refer to Typical Cooling Season)
- COP : Coefficient Of Performance (Heating)
- SCOP : Seasonal Coefficient Of Performance (Refer to Typical Heating Season)

6. Due to our policy of innovation some specifications may be changed without notification.

7. This product contains Fluorinated greenhouse gases. (R410A, GWP (Global warming potential) = 2,087.5)

MULTI VTM S

Highlight

- Air cooled VRF Heat pump & Heat Recovery
- 12.1 ~ 33.6kW (Cooling capacity based)
- Both 1Ø, 220 ~ 240V, 50Hz and 3Ø, 380 ~ 415V, 50Hz
- Side discharge outdoor unit
- Includes the industry's first single phase Heat Recovery system
- Includes the industry's first R32 side discharge



Energy savings



Reliability



Convenience

How does it work?

Available in Heat Pump and Heat Recovery Configurations

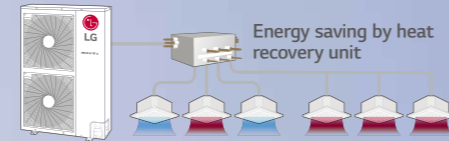

Combination of Cooling, Heating and Hot Water Solution

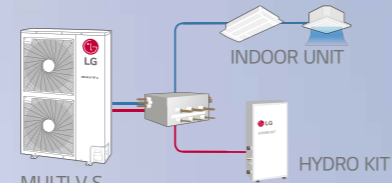

※ Heat Pump and Recovery are separated models.



OUTDOOR UNITS

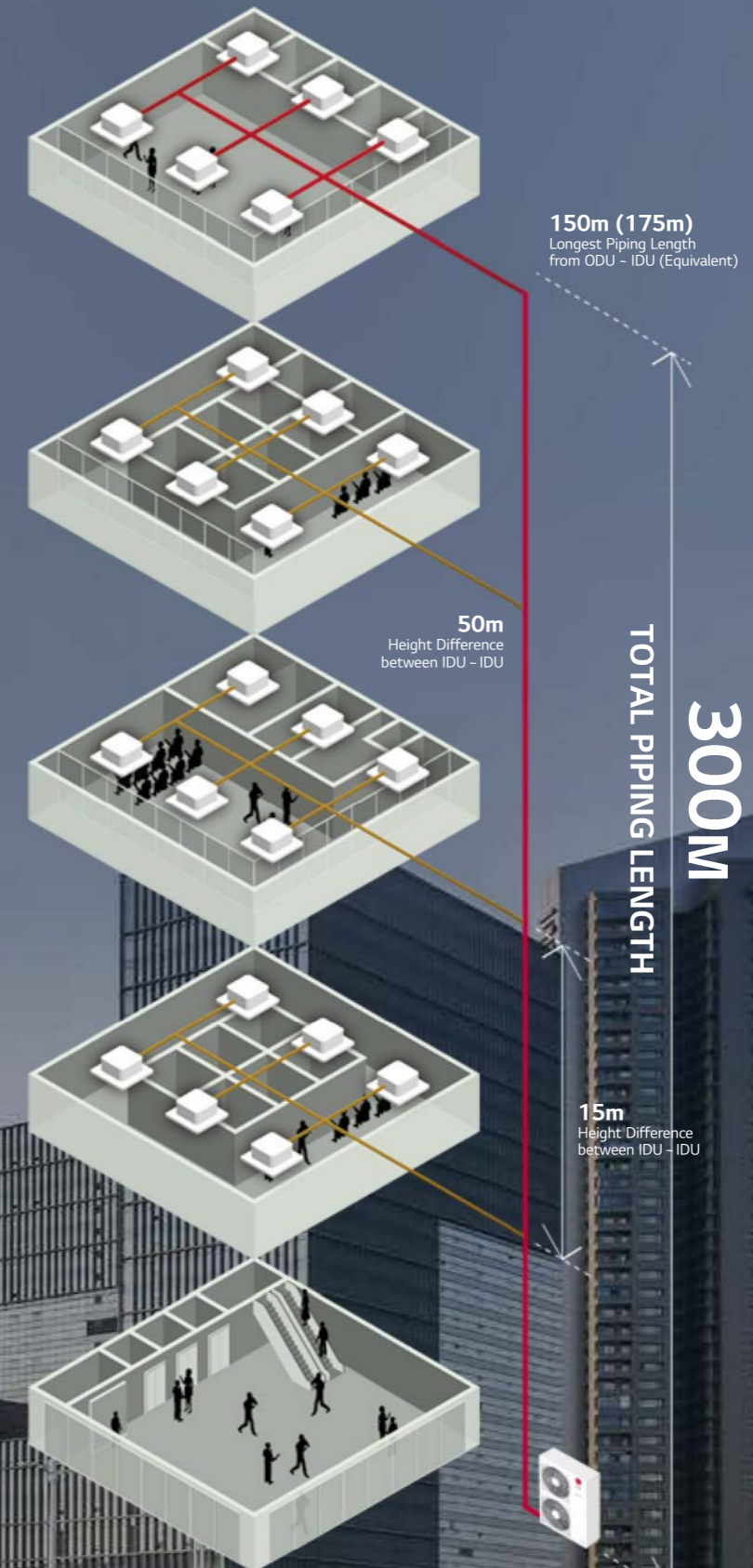

※ Only applies to Multi V S with R410A refrigerant.

EER / COP / Part Load

Cost savings with energy efficiency

Heat Pump

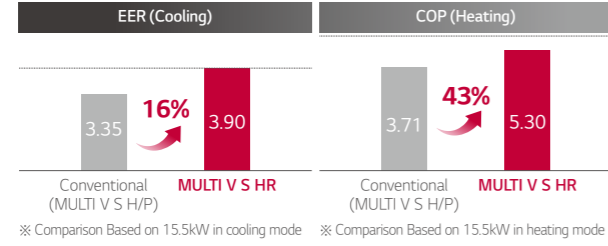

Heat Recovery

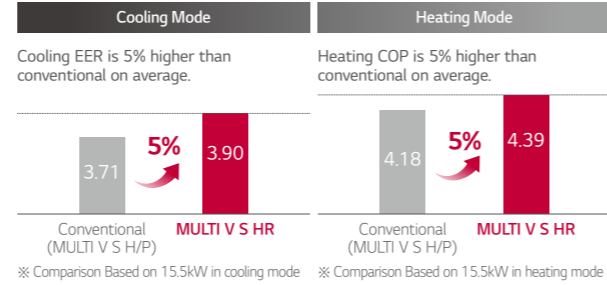

Smart Load Control Applied

Enhanced comfort and up to 23% energy savings with MULTI V load control

MULTI V S changes indoor discharge air temperature continuously according to load, to save energy.

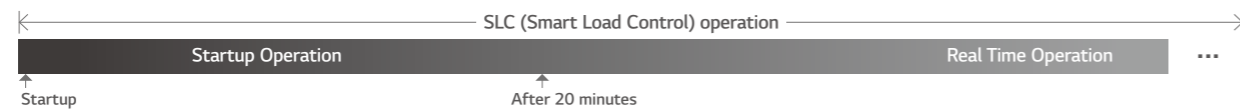

Startup Operation

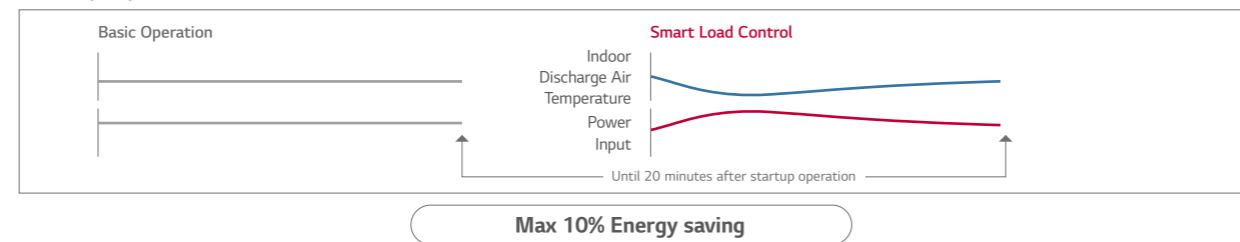

※ Indoor air discharge temperature
 - Energy efficiency increased by 3-step Smart Load Control during startup phase
 - Discharge air temperature adjusted according to outdoor and indoor temperature
 - Comfort level in cooling / heating operations ensured

Real Time Operation

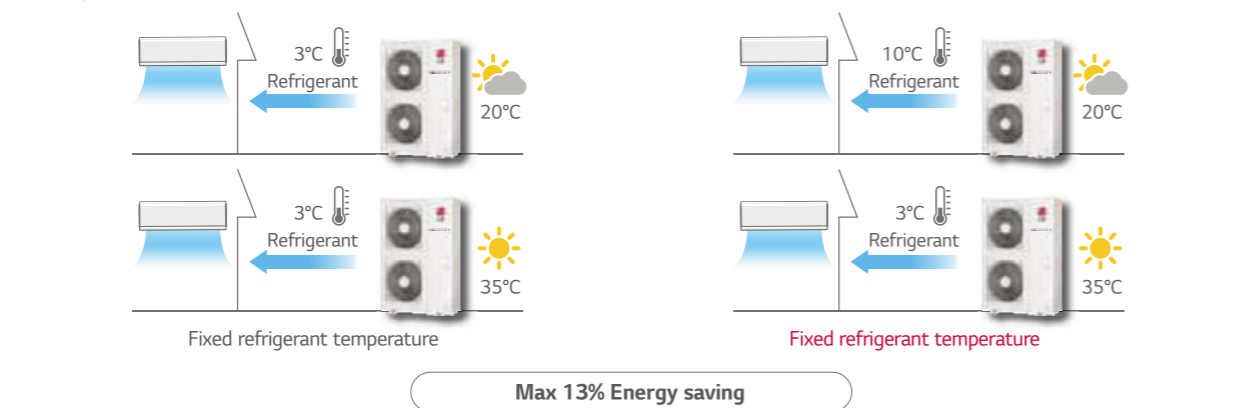

※ How to set up : By dip switch in outdoor unit (Referred to Product Data Book) Factory default setting is Off
 - Outdoor temperature condition : EER 100% / 75% / 50% / 25% = 35°C (DB) / 30°C (DB) / 25°C (DB) / 20°C (DB)
 - Indoor temperature condition : 27°C (DB) / 19°C (WB)
 ※ Dual sensing (Temperature & humidity) smart load control is possible with Remote controller PTMTB100 (White) / PREMTBB10 (Black)

Inverter Twin Rotary & Inverter Scroll Compressor

Adapted High Efficient Compressor according to Capacity

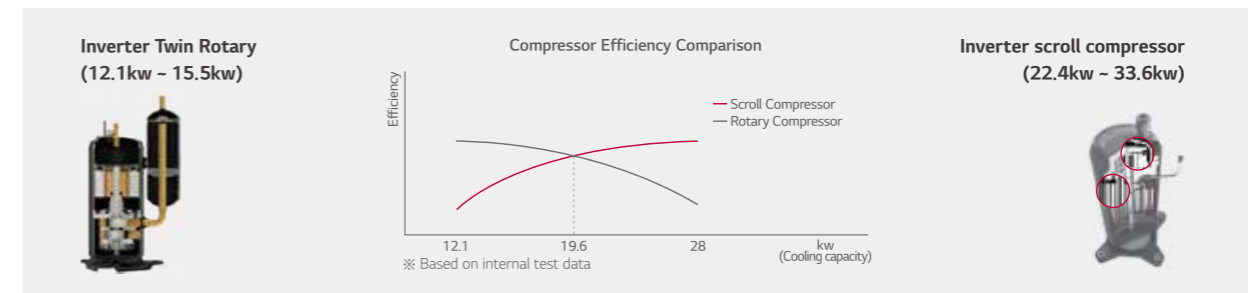

Inverter Twin Rotary

Concentrated Winding Motor

Oil path area is improved by over 50% by increasing the extra stator cavity. Due to this, caloric value of motor is reduced, improving the cooling function of stator coil.



Twin Rotary Rotor

Upper and lower part rotor offset imbalance in shaft rotor rotation. Vibration and noise is reduced. Max torque load decreased by 45% compared to single rotor.



Surface Coating

Surface coating of outstanding abrasion resistance property on vane and crank shaft.



Inverter scroll compressor

Best-in-class Compressor Speed

- Rapid response capability
 - Compact core design (Concentrated motor)
 - Down to 15Hz : Part load efficiency improvement

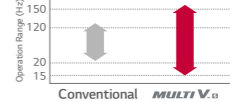

6 Bypass Valve

Compressor reliability is maximized with 6 Bypass Valve
 - Prevent compressor damage due to excessively compressed refrigerant more efficiently than 4 Bypass valve



Direct Oil Injection

- Eliminate suction refrigerant gas heat loss through direct oil injection into compression chamber (Efficiency increases)
 - Increased reliability with regulated oil supply

Scroll Profile

- The enhanced reliability by increased reliability with regulated oil supply
 - Efficiency increases by expanding 96% Bypass area and 17% improved volume ratio by non-uniform scroll thickness

Optimal Heat Exchanger

Maximize Efficiency according to different Heat Exchanger path by cooling and heating

Variable Heat Exchanger Circuit intelligently selects the optimal. With this smart path selection technology, an average of 6% increase in the efficiency of both operations has been achieved.

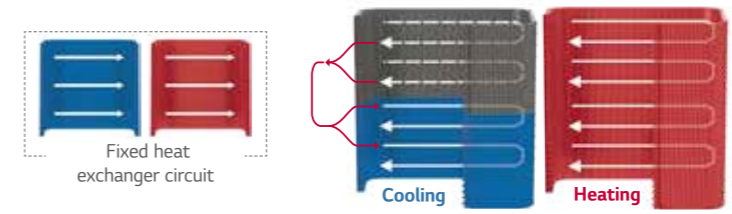

Efficiency performance

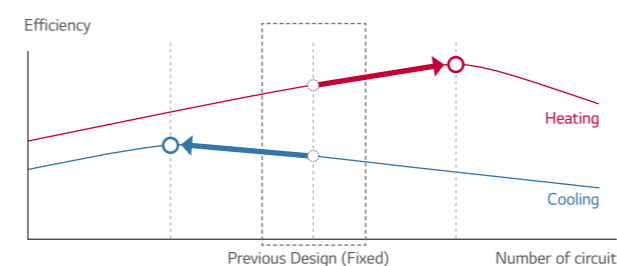

Efficiency up due to Fin shape

Improved heat exchanger efficiency of up to 28%

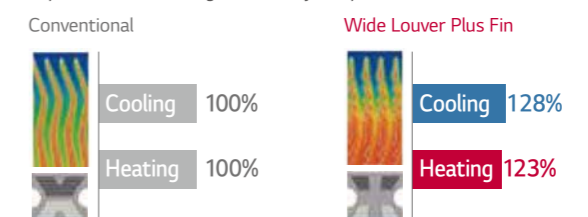

Reliable Refrigerant Components

LG technology allows for superior performance and component durability

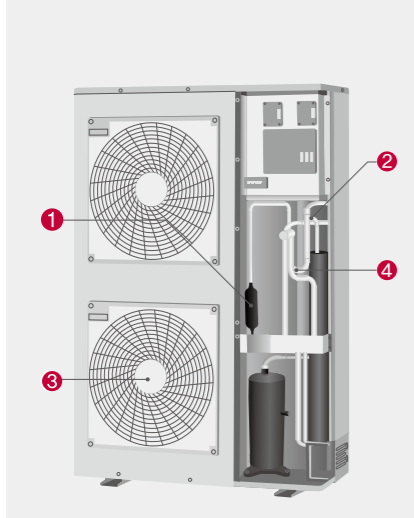

MULTI V S improved reliability with advanced technology :

- Oil separator
- Accumulator
- Sub-cooling

- ### 1 Cyclonic oil separator

 - Highly reliable and efficient oil separation by centrifuge using cyclonic methods
 - High collection efficiency as well as outstanding resistance to high temperature and pressure
- ### 2 Large Volume Accumulator

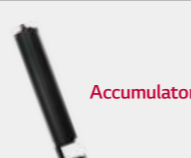
 - Improved reliability by adopting the large volume accumulator (38% volume up compared to conventional)
 - Prevents the liquid refrigerant entering the compressor suction
 - Maximize efficiency by optimal amount of refrigerant
 - Protects compressor breakdown to increase product lifetime
- ### 3 BLDC Fan Motor

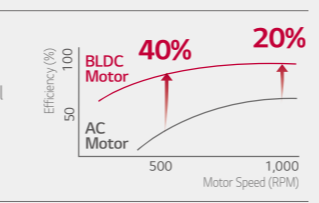
 - The BLDC Fan motor is more efficient than a conventional AC motor, offering an additional 40% energy savings at low speeds and 20% at high speeds
- ### 4 Double Sub-cool Interchanger

 - Reliability is enhanced by minimizing pressure drop due to high efficiency spiral structure and 2 times larger size
 - Long pipe is possible (up to* 175m) and high elevation (up to* 50m)
 - Reduction of indoor refrigerant noise level

* Based on equivalent pipe length

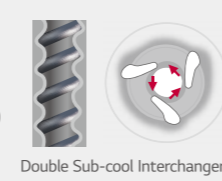

Smart Control

Pressure control applied for smart, quick and precise response to user's temperature request

Temperature + Pressure Control

Senses and controls pressure directly using pressure sensor for faster and more exact response to load variation.



Quick Operating Response

Desired temperature can be reached up to 14% faster in cooling mode with pressure control, allowing more accurate control of indoor environment for maximized comfort.

※ Specifications may vary for each model

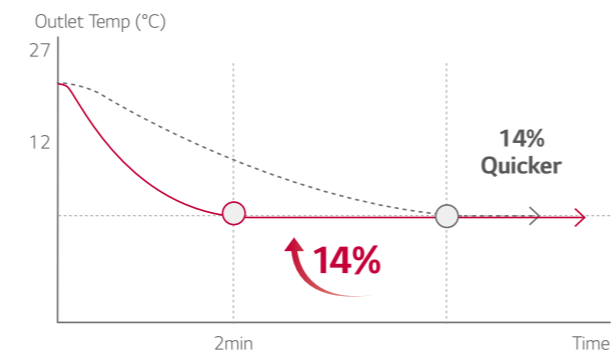

○ Pressure + Temperature Control
○ Temperature Control

Corrosion Resistance Black Fin

Strong Durability against high salinity and heavily polluted air

Black Fin ensures continued operation of MULTI V S in highly corrosive environments like salt concentration in coastal towns or severe air pollution in industrial cities keeps. This improvement in durability prolongs the product's lifespan and lowers both the operational and maintenance costs.

Corrosion Resistance Proven by Certified Tests

LG Corrosion Resistance solution passed ISO 21207 accelerated corrosion test conducted by an independent test organization and the result has been certified by prestigious global certification organization, TUV.



Certified protection

※ Verification of corrosion resistance performance

- Declared by TUV Rheinland
- Test Method B of ISO21207
- Test condition : Salt contaminated condition + severe industrial / traffic environment (NO₂ / SO₂)

Enhanced Coating Layers

The black coating with enhanced epoxy resin is applied for strong protection from various corrosive external conditions such as salt contamination and air pollution. Moreover, the hydrophilic film keeps water from accumulating on the heat exchanger's fin, minimizing moisture buildup and eventually making it even more corrosion resistant.

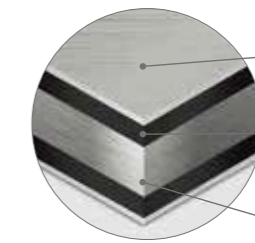

Hydrophilic film (Water flow)
The Hydrophilic coating minimizes moisture buildup on the fin.

Acryl + Epoxy + Melamine resin (Corrosion resistant)
The Black coating provides strong protection from corrosion.

Aluminum fin

Sufficient Piping Length

Increased piping length allows for flexible design and installation

MULTI V S inverter technology and sub cooling control circuit technology allows greater piping length and outstanding elevation differences. A cooling system can be implemented more flexibly in a shop, office and even high-rise building, reducing the designer's work time and providing more efficient design.

Piping Capabilities

300m Total piping length

150m (175m) Longest pipe length (Equivalent)

50m ODU - IDU Height difference

15m IDU - IDU Height difference

4 Way Piping

- Free design and installation by 4 way piping.

Low Noise Operation

Decreased noise during operation with low noise functionality

At night mode, noise reduced maximum 14% compared to normal mode.

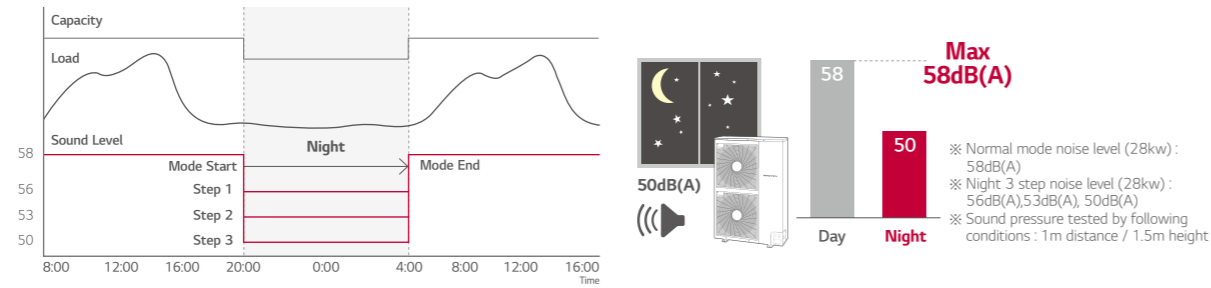

Fan Technology and RPM Control

External static pressure control for outdoor unit fan to adapt more flexibly to various installation conditions of outdoor unit

For enhanced efficiency, new axial fan boasts higher air volume, increased static pressure and decreased noise.

Fan Technology

The new axial fan has a mogul trailing edge, narrow hub blade and reverse hub, this provides a high efficiency, low noise, wide fan, as well as improving the air flow rate.

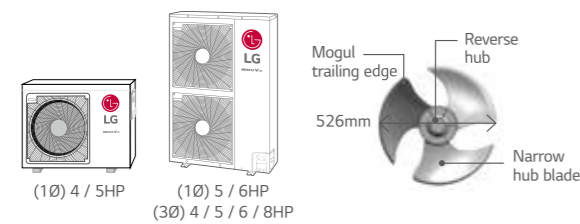

Super canon fan increases the air volume in 50 CMM and the noise level is decreased by 4dB(A).

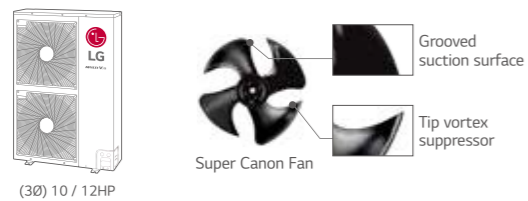

Fan RPM control

Flow of air is straight due to fan shroud and Fan RPM control even in high-rise building.

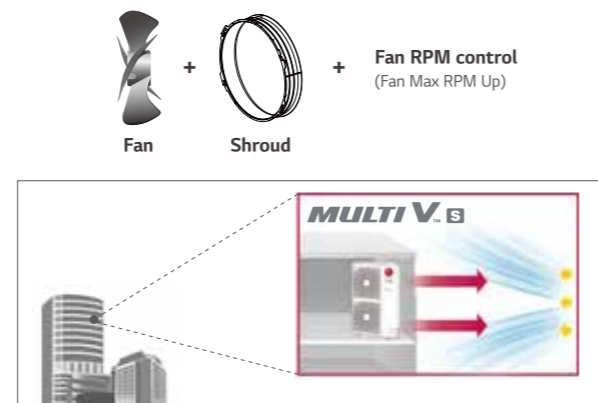

- Straight air flow
- New shroud adopted
- Performs high static pressure

Upgraded Fault Detection and Diagnosis

Easy and convenient maintenance with self-diagnosis

The inclusion of FDD elements - Auto start-up, auto refrigerant check, black box functionality, simultaneous evaluation, and auto refrigerant collection, provides the optimal solution for user reliability and ease of maintenance.

- Auto commissioning Mode
- Auto Refrigerant Collection
- Auto evaluation of refrigerant amount and charging
- Able to access LGMV (LG Monitoring View) by smartphone
- Black box function
- Piping & wiring error check-up

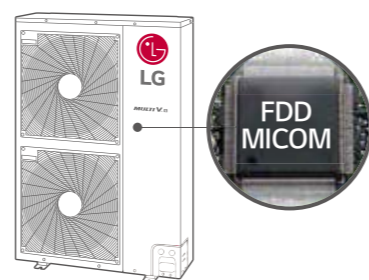

Nomenclature

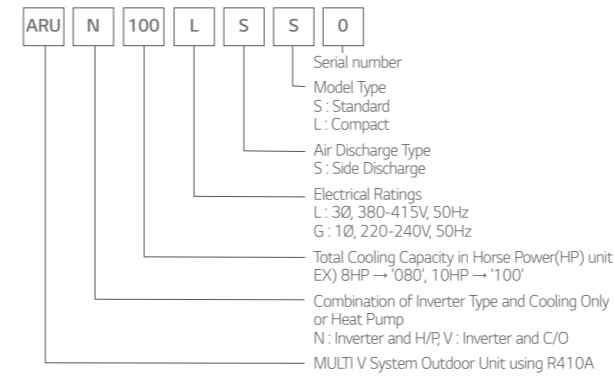

Outdoor Units Function

Category	Functions	MULTI V S	
Key Refrigerant Components	Variable Path of Outdoor Unit HEX	-	
	HiPOR™ (High Pressure Oil Return)	-	
	Humidity Sensor	ARUB060GSS4 only	
	Corrosion Resistance Black Fin	○	
	Oil Sensor	-	
Special Function	Dual Sensing	ARUB060GSS4 only	
	Low Noise Operation	○	
	High Static Mode of Outdoor Unit Fan	○	
	Partial Defrosting	-	
Basic Function	Auto Dust Removal of Outdoor Unit (Fan reverse rotation)	-	
	Indoor Cooling Comfort Mode Based Outdoor Temperature	○	
	Smart Load Control (SLC) (Changing indoor discharge air temperature according to load)	○	
	Outdoor Unit Control Refer to Humidity	ARUB060GSS4 only	
	Defrost / Deicing	○	
	High Pressure Switch	○	
	Phase Protection	○	
	Restart Delay (3-minutes)	○	
	Self Diagnosis	○	
	Soft Start	○	
Central Controller	Test Run Function	-	
	AC Ez (Simple Controller)	PQCSZ250S0	
	AC Ez Touch	PACEZA000	
	AC Smart IV	PACS4B000	
	AC Smart 5	PACSSA000	
	ACP (Advanced Control Platform) IV	PACP4B000	
	ACP (Advanced Control Platform) S	PACPSA000	
	AC Manager 5	PACMSA000	
	BNU (Building Network Unit)	ACPNLON000	
	ACPNBAC000	PQNF17C0	
IO Module (ODU Dry Contact)	PVDSMN000	PVDSMN000	
	PDI (Power Distribution Indicator)	Standard	PPWRDB000
	Premium	PQNUD1S40	
Cool / Heat Selector	PRDSBM	PRDSBM	
	PRCTILO	PRCTILO	
Cycle Monitoring Device	LGMV	PLGMVW100	
	Mobile LGMV	PLGMVW100	
Additional kit	Refrigerant Charging Kit	○ (Logical operation) Not applied to ARUB060GSS4	
	Low Ambient Kit	-	
	Variable Water Flow Valve Control Kit	-	

※ ○ : Applied, - : Not Applied

ARUN040GSS0

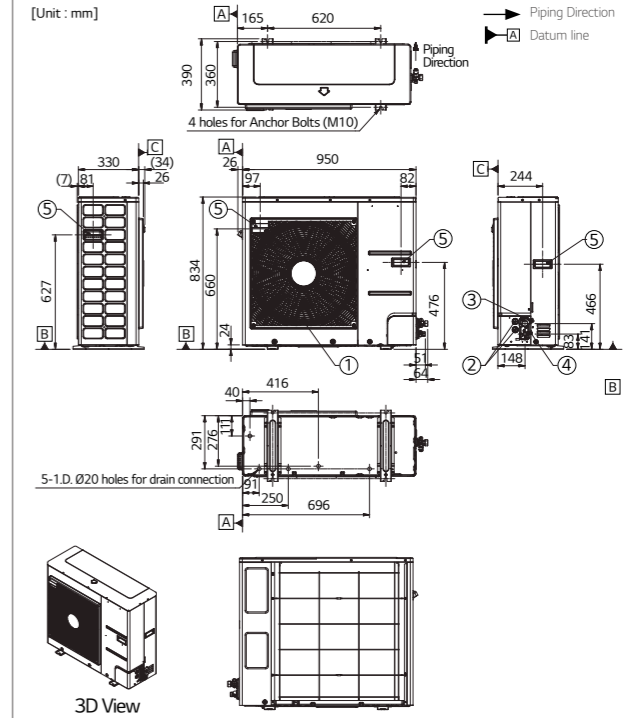

ARUN080LSS0

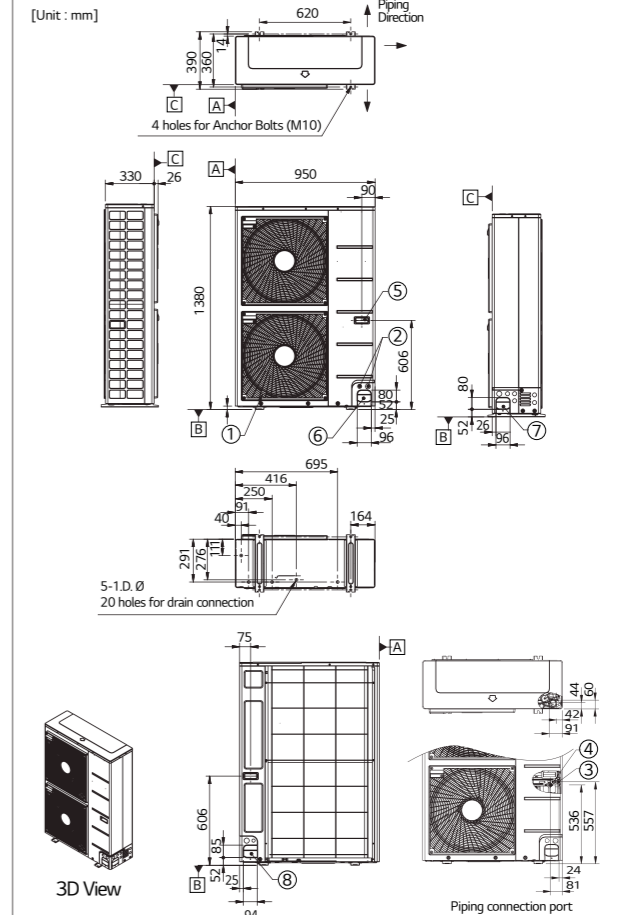

Note

- Unit should be installed in compliance with the installation manual in the product box.
- Unit should be grounded in accordance with the local regulation or applicable national codes.
- All electrical components and materials to be supplied from the site must comply with the local regulations or international codes.
- Electrical characteristics chapter should be considered for electrical work and design. Especially the power cable and circuit breaker should be selected in accordance with that.

No.	Part Name	Description
1	Air Outlet	-
2	Power and communication cable Hole	-
3	Gas Pipe Connection	Welding joint
4	Liquid Pipe Connection	Welding joint
5	Handle	-
6	Pipe routing hole (front)	-
7	Pipe routing hole (side)	-
8	Pipe routing hole (back)	-

Heat Pump

Cooling

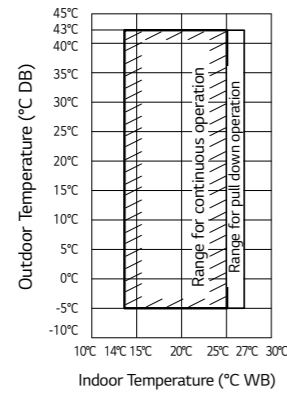

Heating

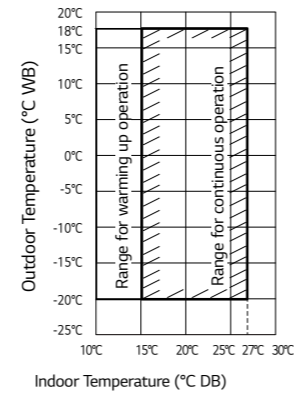

Heat Recovery

Cooling

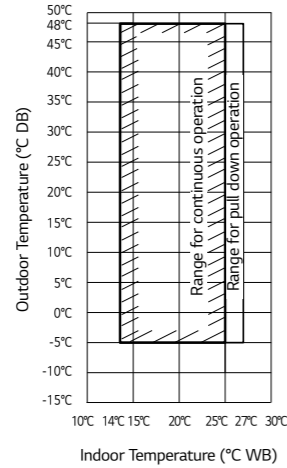

Heating

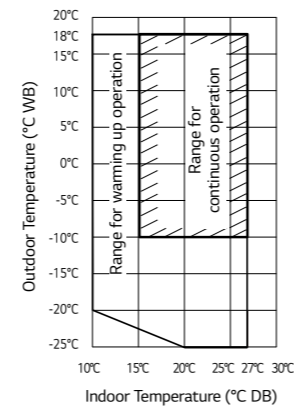

Simultaneous Cooling

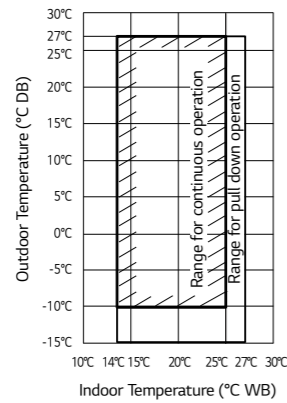

Simultaneous Heating

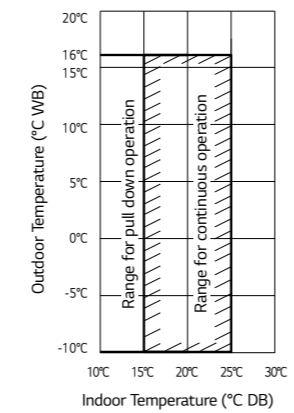

Note
 1. These figures assume the following operating conditions : Equivalent piping length : 7.5m
 Level difference : 0m
 2. Range of pull down operation : If the relative humidity is too high, cooling capacity can be decreased by the sensible

Position of Sound Level Measuring

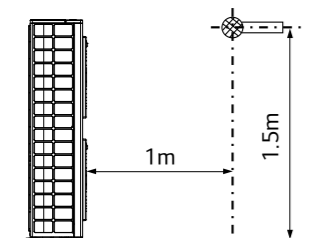

Note
 1. These figures assume the following operating conditions :
 Equivalent piping length : 7.5m
 Level difference : 0m

ARUN040GSS0 / ARUN050GSL0



LG participates in the ECP programme for EUROVENT VRF program. Check ongoing validity of certification : www.eurovent-certification.com

HP		4	5	
Model Name		ARUN040GSS0	ARUN050GSL0	
Capacity	Cooling (Rated)	kW	12.1	14.0
	Heating (Rated)	kW	12.5	15.0
Input	Cooling (Rated)	kW	3.78	4.38
	Heating (Rated)	kW	2.10	2.65
EER			3.20	3.20
SEER			5.98	6.60
COP	Rated Capacity		5.9	5.7
SCOP			5.15	4.96
Exterior	Color (General)		Warm Gray	Warm Gray
	RAL Code (Classic)		RAL 7044	RAL 7044
Heat Exchanger	Type		Wide Louver Plus / Black Fin	Wide Louver Plus / Black Fin
	Type		BLDC Inverter Twin Rotary	BLDC Inverter Twin Rotary
Compressor	Combination x No.		(Inverter) x 1	(Inverter) x 1
	Motor Output x Number	W x No.	4,000 x 1	4,000 x 1
	Oil Type		FVC68D (PVE)	FVC68D (PVE)
Oil Charge	cc		1,300	1,300
	Type		Axial Flow Fan	Axial Flow Fan
Fan	Motor Output x Number	W x No.	124 x 1	124 x 1
	Air Flow Rate (High)	m ³ /min x No.	60 x 1	60 x 1
	Drive		DC INVERTER	DC INVERTER
Pipe Connection	Discharge	Side / Top	Side	Side
	Liquid Pipe	mm (inch)	Ø9.52 (3/8)	Ø9.52 (3/8)
Dimensions (W x H x D)	Gas Pipe	mm (inch)	Ø15.88 (5/8)	Ø15.88 (5/8)
	mm x No.		(950 x 834 x 330) x 1	(950 x 834 x 330) x 1
Dimensions (W x H x D) - Shipping	mm x No.		(1,065 x 918 x 461) x 1	(1,065 x 918 x 461) x 1
Net Weight	kg x No.		70 x 1	73 x 1
Shipping Weight	kg x No.		77 x 1	81 x 1
Sound Pressure Level	Cooling	dB(A)	50.0	52.0
	Heating	dB(A)	52.0	58.0
Sound Power Level	Cooling	dB(A)	72.0	72.0
	Heating	dB(A)	76.0	75.0
Communication Cable	mm ² x No. (VCTF-SB)		1.0 - 1.5 x 2C	1.0 - 1.5 x 2C
Refrigerant	Refrigerant Name		R410A	R410A
	Precharged Amount in factory	kg	1.8	2.4
	t-CO ₂ eq		3.758	5.010
Control			Electronic Expansion Valve	Electronic Expansion Valve
Power Supply	Ø, V, Hz		1, 220-240, 50	1, 220-240, 50
Number of Maximum Connectable Indoor Units			8	8*

* In case of ARUN050GSL0, maximum combination ratio is 130%.

- Note
- Eurovent Test Condition : Type of indoor unit connected is only Ceiling Concealed Duct.
 - Refer to EUROVENT certification regulation for more detail test conditions.
 - Refer to EUROVENT website for test values connected Ceiling Cassette type indoors.
 - Performances are based on the following conditions :
 - Cooling Temperature : Indoor 27°C (80.6°F) DB / 19°C (66.2°F) WB / Outdoor 35°C (95°F) DB / 24°C (75.2°F) WB
 - Heating Temperature : Indoor 20°C (68°F) DB / 15°C (59°F) WB / Outdoor 7°C (44.6°F) DB / 6°C (42.8°F) WB
 - The maximum combination ratio is 160% (the maximum combination ratio of ARUN050GSL0 is 130%).
 - Wiring cable size must comply with the applicable local and national codes.
 - Due to our policy of innovation some specifications may be changed without notification.
 - Sound pressure level is measured on the rated condition in the anechoic rooms by ISO 3745 standard. Sound power level is measured on the rated condition in the reverberation rooms by ISO 3741 standard. Therefore, these values can be increased owing to ambient conditions during operation.
 - Power factor could vary less than ±1% according to the operating conditions.
 - This product contains Fluorinated greenhouse gases. (R410A, GWP(Global warming potential) = 2087.5)

ARUN050GSS0 / ARUN060GSS0



LG participates in the ECP programme for EUROVENT VRF program. Check ongoing validity of certification : www.eurovent-certification.com

HP			5	6
Model Name			ARUN050GSS0	ARUN060GSS0
Capacity	Cooling (Rated)	kW	14.0	15.5
	Heating (Rated)	kW	16.0	18.0
Input	Cooling (Rated)	kW	3.33	3.97
	Heating (Rated)	kW	2.77	3.40
EER			4.20	3.90
SEER			6.56	6.65
COP Rated Capacity			5.77	5.30
SCOP			5.23	5.19
Exterior	Color (General)		Warm Gray	Warm Gray
	RAL Code (Classic)		RAL 7044	RAL 7044
Heat Exchanger	Type		Wide Louver Plus / Black Fin	Wide Louver Plus / Black Fin
	Type		BLDC Inverter Twin Rotary	BLDC Inverter Twin Rotary
Compressor	Combination x No.		(Inverter) x 1	(Inverter) x 1
	Motor Output x Number	W x No.	4,000 x 1	4,000 x 1
	Oil Type		FVC68D (PVE)	FVC68D (PVE)
	Oil Charge	cc	1,300	1,300
	Type		Axial Flow Fan	Axial Flow Fan
Fan	Motor Output x Number	W x No.	124 x 2	124 x 2
	Air Flow Rate (High)	m ³ /min x No.	110 x 1	110 x 1
	Drive		DC INVERTER	DC INVERTER
	Discharge	Side / Top	Side	Side
Pipe Connection	Liquid Pipe	mm (inch)	Ø9.52 (3/8)	Ø9.52 (3/8)
	Gas Pipe	mm (inch)	Ø15.88 (5/8)	Ø19.05 (3/4)
Dimensions (W x H x D)		mm x No.	(950 x 1,380 x 330) x 1	(950 x 1,380 x 330) x 1
Dimensions (W x H x D) - Shipping		mm x No.	(1,140 x 1,462 x 461) x 1	(1,140 x 1,462 x 461) x 1
Net Weight		kg x No.	94 x 1	94 x 1
Shipping Weight		kg x No.	106 x 1	106 x 1
Sound Pressure Level	Cooling	dB(A)	51.0	52.0
	Heating	dB(A)	53.0	54.0
Sound Power Level	Cooling	dB(A)	72.0	72.0
	Heating	dB(A)	76.0	77.0
Communication Cable		mm ² x No. (VCTF-SB)	1.0 - 1.5 x 2C	1.0 - 1.5 x 2C
Refrigerant	Refrigerant Name		R410A	R410A
	Precharged Amount in factory	kg	3.0	3.0
	t-CO ₂ eq		6.263	6.263
	Control		Electronic Expansion Valve	Electronic Expansion Valve
Power Supply		Ø, V, Hz	1, 220-240, 50	1, 220-240, 50
Number of Maximum Connectable Indoor Units			10	13

Note
 1. Eurovent Test Condition : Type of indoor unit connected is only Ceiling Concealed Duct.
 - Refer to EUROVENT certification regulation for more detail test conditions.
 - Refer to EUROVENT website for test values connected Ceiling Cassette type indoors.
 2. Performances are based on the following conditions :
 - Cooling Temperature : Indoor 27°C (80.6°F) DB / 19°C (66.2°F) WB / Outdoor 35°C (95°F) DB / 24°C (75.2°F) WB
 - Heating Temperature : Indoor 20°C (68°F) DB / 15°C (59°F) WB / Outdoor 7°C (44.6°F) DB / 6°C (42.8°F) WB
 3. The maximum combination ratio is 160% (the maximum combination ratio of ARUN050GSS0 is 130%).
 4. Wiring cable size must comply with the applicable local and national codes.
 5. Due to our policy of innovation some specifications may be changed without notification.
 6. Sound pressure level is measured on the rated condition in the anechoic rooms by ISO 3745 standard. Sound power level is measured on the rated condition in the reverberation rooms by ISO 3741 standard. Therefore, these values can be increased owing to ambient conditions during operation.
 7. Power factor could vary less than ±1% according to the operating conditions.
 8. This product contains Fluorinated greenhouse gases. (R410A, GWP(Global warming potential) = 2087.5)

ARUN040LSS0 / ARUN050LSS0
ARUN060LSS0



LG participates in the ECP programme for EUROVENT VRF program. Check ongoing validity of certification : www.eurovent-certification.com

HP			4	5	6
Model Name			ARUN040LSS0	ARUN050LSS0	ARUN060LSS0
Capacity	Cooling (Rated)	kW	12.1	14.0	15.5
	Heating (Rated)	kW	12.5	16.0	18.0
Input	Cooling (Rated)	kW	2.37	3.33	3.97
	Heating (Rated)	kW	1.93	2.77	3.40
EER			5.10	4.20	3.90
SEER			6.46	6.56	6.65
COP Rated Capacity			6.49	5.77	5.30
SCOP			5.02	5.23	5.19
Exterior	Color (General)		Warm Gray	Warm Gray	Warm Gray
	RAL Code (Classic)		RAL 7044	RAL 7044	RAL 7044
Heat Exchanger	Type		Wide Louver Plus / Black Fin	Wide Louver Plus / Black Fin	Wide Louver Plus / Black Fin
	Type		BLDC Inverter Twin Rotary	BLDC Inverter Twin Rotary	BLDC Inverter Twin Rotary
Compressor	Combination x No.		(Inverter) x 1	(Inverter) x 1	(Inverter) x 1
	Motor Output x Number	W x No.	4,000 x 1	4,000 x 1	4,000 x 1
	Oil Type		FVC68D (PVE)	FVC68D (PVE)	FVC68D (PVE)
	Oil Charge	cc	1,300	1,300	1,300
	Type		Axial Flow Fan	Axial Flow Fan	Axial Flow Fan
Fan	Motor Output x Number	W x No.	124 x 2	124 x 2	124 x 2
	Air Flow Rate (High)	m ³ /min x No.	110 x 1	110 x 1	110 x 1
	Drive		DC INVERTER	DC INVERTER	DC INVERTER
	Discharge	Side / Top	Side	Side	Side
Pipe Connection	Liquid Pipe	mm (inch)	Ø9.52 (3/8)	Ø9.52 (3/8)	Ø9.52 (3/8)
	Gas Pipe	mm (inch)	Ø15.88 (5/8)	Ø15.88 (5/8)	Ø19.05 (3/4)
Dimensions (W x H x D)		mm x No.	(950 x 1,380 x 330) x 1	(950 x 1,380 x 330) x 1	(950 x 1,380 x 330) x 1
Dimensions (W x H x D) - Shipping		mm x No.	(1,140 x 1,462 x 461) x 1	(1,140 x 1,462 x 461) x 1	(1,140 x 1,462 x 461) x 1
Net Weight		kg x No.	96 x 1	96 x 1	96 x 1
Shipping Weight		kg x No.	108 x 1	106 x 1	106 x 1
Sound Pressure Level	Cooling	dB(A)	50.0	51.0	52.0
	Heating	dB(A)	52.0	53.0	54.0
Sound Power Level	Cooling	dB(A)	72.0	72.0	72.0
	Heating	dB(A)	76.0	76.0	77.0
Communication Cable		mm ² x No. (VCTF-SB)	1.0 - 1.5 x 2C	1.0 - 1.5 x 2C	1.0 - 1.5 x 2C
Refrigerant	Refrigerant Name		R410A	R410A	R410A
	Precharged Amount in factory	kg	3.0	3.0	3.0
	t-CO ₂ eq		6.263	6.263	6.263
	Control		Electronic Expansion Valve	Electronic Expansion Valve	Electronic Expansion Valve
Power Supply		Ø, V, Hz	3, 380-415, 50	3, 380-415, 50	3, 380-415, 50
Number of Maximum Connectable Indoor Units			8	10	13

Note
 1. Eurovent Test Condition : Type of indoor unit connected is only Ceiling Concealed Duct.
 - Refer to EUROVENT certification regulation for more detail test conditions.
 - Refer to EUROVENT website for test values connected Ceiling Cassette type indoors.
 2. Performances are based on the following conditions :
 - Cooling Temperature : Indoor 27°C (80.6°F) DB / 19°C (66.2°F) WB / Outdoor 35°C (95°F) DB / 24°C (75.2°F) WB
 - Heating Temperature : Indoor 20°C (68°F) DB / 15°C (59°F) WB / Outdoor 7°C (44.6°F) DB / 6°C (42.8°F) WB
 3. The maximum combination ratio is 160% (the maximum combination ratio of ARUN050GSS0 is 130%).
 4. Wiring cable size must comply with the applicable local and national codes.
 5. Due to our policy of innovation some specifications may be changed without notification.
 6. Sound pressure level is measured on the rated condition in the anechoic rooms by ISO 3745 standard. Sound power level is measured on the rated condition in the reverberation rooms by ISO 3741 standard. Therefore, these values can be increased owing to ambient conditions during operation.
 7. Power factor could vary less than ±1% according to the operating conditions.
 8. This product contains Fluorinated greenhouse gases. (R410A, GWP(Global warming potential) = 2087.5)

ARUN080LSS0 / ARUN100LSS0
ARUN120LSS0



LG participates in the ECP programme for EUROVENT VRF program. Check ongoing validity of certification : www.eurovent-certification.com

HP			8	10	12
Model Name			ARUN080LSS0	ARUN100LSS0	ARUN120LSS0
Capacity	Cooling (Rated)	kW	22.4	28.0	33.6
	Heating (Rated)	kW	24.5	30.6	36.7
Input	Cooling (Rated)	kW	8.30	8.75	14.00
	Heating (Rated)	kW	6.62	8.12	7.46
EER			2.70	3.20	2.40
SEER			6.03	6.59	5.72
COP Rated Capacity			3.70	3.77	4.92
SCOP			4.33	4.17	3.86
Exterior	Color (General)		Warm Gray	Warm Gray	Warm Gray
	RAL Code (Classic), General		RAL 7044	RAL 7044	RAL 7044
Heat Exchanger	Type		Wide Louver Plus / Black Fin	Wide Louver Plus / Black Fin	Wide Louver Plus / Black Fin
	Type		Hermetically Sealed Scroll	Hermetically Sealed Scroll	Hermetically Sealed Scroll
Compressor	Combination x No.		(Inverter) x 1	(Inverter) x 1	(Inverter) x 1
	Motor Output x Number	W x No.	4,200 x 1	5,300 x 1	5,300 x 1
	Oil Type		FVC68D (PVE)	FVC68D (PVE)	FVC68D (PVE)
	Oil Charge	cc	2,400	2,600	3,400
	Type		Propeller fan	Propeller fan	Propeller fan
Fan	Motor Output x Number	W x No.	124 x 2	250 x 2	250 x 2
	Air Flow Rate (High)	m ³ /min x No.	140 x 1	190 x 1	190 x 1
	Drive		DC INVERTER	DC INVERTER	DC INVERTER
	Discharge	Side / Top	Side	Side	Side
	Liquid Pipe	mm (inch)	Ø9.52 (3/8)	Ø9.52 (3/8)	Ø12.7 (1/2)
Pipe Connection	Gas Pipe	mm (inch)	Ø19.05 (3/4)	Ø22.2 (7/8)	Ø28.58 (1-1/8)
	Dimensions (W x H x D)	mm x No.	(950 x 1,380 x 330) x 1	(1,090 x 1,625 x 380) x 1	(1,090 x 1,625 x 380) x 1
Dimensions (W x H x D) - Shipping		mm x No.	(1,140 x 1,462 x 461) x 1	(1,215 x 1,795 x 500) x 1	(1,215 x 1,795 x 500) x 1
Net Weight		kg x No.	115 x 1	144 x 1	157 x 1
Shipping Weight		kg x No.	127 x 1	160 x 1	173 x 1
Sound Pressure Level	Cooling	dB(A)	57.0	58.0	60.0
	Heating	dB(A)	57.0	58.0	60.0
Sound Power Level	Cooling	dB(A)	81.0	80.0	81.0
	Heating	dB(A)	84.0	84.0	85.0
Communication Cable		mm ² x No. (VCTF-SB)	1.0 - 1.5 x 2C	1.0 - 1.5 x 2C	1.0 - 1.5 x 2C
Refrigerant	Refrigerant Name		R410A	R410A	R410A
	Precharged Amount in factory	kg	3.5	4.5	6.0
	t-CO ₂ eq		7.306	9.394	12.525
	Control		Electronic Expansion Valve	Electronic Expansion Valve	Electronic Expansion Valve
Power Supply		Ø, V, Hz	3, 380-415, 50	3, 380-415, 50	3, 380-415, 50
Number of Maximum Connectable Indoor Units			13	16	20

Note

- Eurovent Test Condition : Type of indoor unit connected is only Ceiling Concealed Duct.
 - Refer to EUROVENT certification regulation for more detail test conditions.
 - Refer to EUROVENT website for test values connected Ceiling Cassette type indoors.
- Performances are based on the following conditions :
 - Cooling Temperature : Indoor 27°C (80.6°F) DB / 19°C (66.2°F) WB / Outdoor 35°C (95°F) DB / 24°C (75.2°F) WB
 - Heating Temperature : Indoor 20°C (68°F) DB / 15°C (59°F) WB / Outdoor 7°C (44.6°F) DB / 6°C (42.8°F) WB
- The maximum combination ratio is 160% (the maximum combination ratio of ARUN050GSL0 is 130%).
- Wiring cable size must comply with the applicable local and national codes.
- Due to our policy of innovation some specifications may be changed without notification.
- Sound pressure level is measured on the rated condition in the anechoic rooms by ISO 3745 standard. Sound power level is measured on the rated condition in the reverberation rooms by ISO 3741 standard. Therefore, these values can be increased owing to ambient conditions during operation.
- Power factor could vary less than ±1% according to the operating conditions.
- This product contains Fluorinated greenhouse gases. (R410A, GWP(Global warming potential) = 2087.5)

ARUB060GSS4



LG participates in the ECP programme for EUROVENT VRF program. Check ongoing validity of certification : www.eurovent-certification.com

HP			6
Model Name			ARUB060GSS4
Capacity	Cooling (Rated)	kW	15.5
	Heating (Rated)	kW	18.0
Input	Cooling (Rated)	kW	3.83
	Heating (Rated)	kW	3.64
EER			4.05
SEER			6.84
COP Rated Capacity			4.94
SCOP			4.38
Exterior	Color		Warm Gray
	RAL Code (Classic)		RAL 7044
Heat Exchanger	Type		Wide Louver Plus
	Type		Hermetically Sealed Scroll
Compressor	Combination x No.		(Inverter) x 1
	Motor Output x Number	W x No.	4,200 x 1
	Oil Type		FVC68D (PVE)
	Oil Charge	cc	1,700
	Type		Axial Flow Fan
Fan	Motor Output x Number	W x No.	124 x 2
	Air Flow Rate (High)	m ³ /min x No.	110 x 1
	Drive		DC INVERTER
	Discharge	Side / Top	Side
	Liquid Pipe	mm (inch)	Ø9.52 (3/8)
Pipe Connection #1	Low Pressure Gas Pipe	mm (inch)	Ø19.05 (3/4)
	High Pressure Gas Pipe	mm (inch)	Ø15.88 (5/8)
	Dimensions (W x H x D)	mm x No.	(950 x 1,380 x 330) x 1
Dimensions (W x H x D) - shipping		mm x No.	(1,140 x 1,549 x 466) x 1
Net Weight		kg x No.	118 x 1
Shipping Weight		kg x No.	132 x 1
Sound Pressure Level	Cooling	dB(A)	56
	Heating	dB(A)	58
Sound Power Level	Cooling	dB(A)	69
	Heating	dB(A)	71
Communication Cable		mm ² x No. (VCTF-SB)	1.0 - 1.5 x 2C
Refrigerant	Refrigerant Name		R410A
	Precharged Amount in factory	kg	3.5
	t-CO ₂ eq		7.306
	Control		Electronic Expansion Valve
Power Supply		Ø, V, Hz	1, 220-240, 50
Number of Maximum Connectable Indoor Units			13

Note

- Eurovent Test Condition : Type of indoor unit connected is only Ceiling Concealed Duct.
 - Refer to EUROVENT certification regulation for more detail test conditions.
 - Refer to EUROVENT website for test values connected Ceiling Cassette type indoors.
- Performances are based on the following conditions :
 - Cooling Temperature : Indoor 27°C (80.6°F) DB / 19°C (66.2°F) WB / Outdoor 35°C (95°F) DB / 24°C (75.2°F) WB
 - Heating Temperature : Indoor 20°C (68°F) DB / 15°C (59°F) WB / Outdoor 7°C (44.6°F) DB / 6°C (42.8°F) WB
- The maximum combination ratio is 160% (the maximum combination ratio of ARUN050GSL0 is 130%).
- Wiring cable size must comply with the applicable local and national codes.
- Due to our policy of innovation some specifications may be changed without notification.
- Sound pressure level is measured on the rated condition in the anechoic rooms by ISO 3745 standard. Sound power level is measured on the rated condition in the reverberation rooms by ISO 3741 standard. Therefore, these values can be increased owing to ambient conditions during operation.
- Power factor could vary less than ±1% according to the operating conditions.
- This product contains Fluorinated greenhouse gases. (R410A, GWP(Global warming potential) = 2087.5)

Energy Savings

Energy consumption can be reduced as indoor heat is absorbed and transferred to hot water supply.

Conventional

Absorbed heat is released to outdoor air.

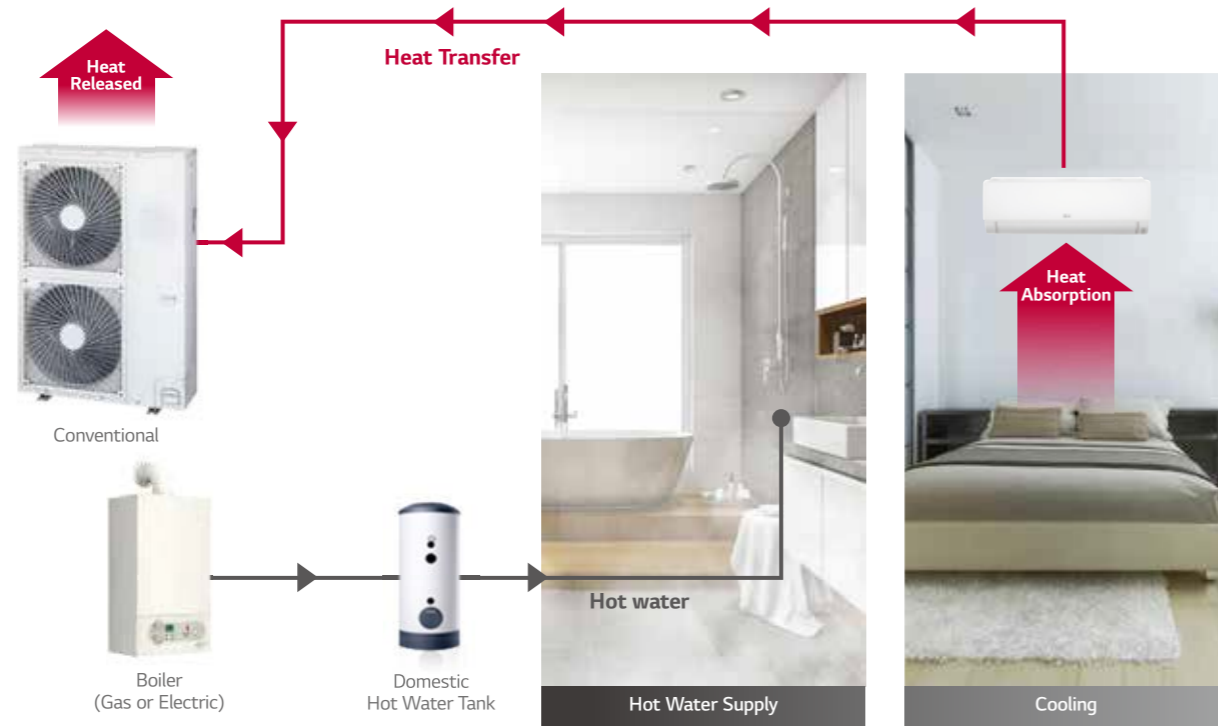

Energy Savings

Energy consumption can be reduced as indoor heat is absorbed and transferred to hot water supply.

MULTI V S Heat Recovery with HYDRO KIT

Absorbed heat from indoor space is used for making hot water.



MULTI V™ S R32

- Air cooled VRF Heat pump
- 12.1 ~ 15.5kW (Cooling capacity based)
- Both 1Ø, 220 ~ 240V, 50Hz and 3Ø, 380 ~ 415V, 50Hz
- Side discharge outdoor unit



Higher Efficiency

LG Multi V S achieved high efficiency through technology of biomimetic fan and revolutionary scroll compressor.

EER 3.65
COP 4.10

VS



Superior to competitor's

EER 4.20
COP 5.15

EER 15% ↑ COP 25% ↑

※ The values based on 5HP model

Compact Size & Light Weight

Its compact size and light weight make it easy to install and optimize space. (5/6HP)



546mm ↓

23% ↓
Light Weight



Previous



New

Less Refrigerant Charge

LG reduced refrigerant charge by applying environment-conscious refrigerant R32.

Total amount : 5.6 kg
Factory Charging : 3 kg



Previous

Total amount : 4.3 kg 23% ↓
Factory Charging : 2 kg



New

※ IDU (Wall Mounted Unit) : 5 kBTu/h, 8 EA
※ This result can be different depending on actual environment

Corrosion Resistance Black Fin

Enhanced Coating Layers

The black coating with enhanced epoxy resin is applied for strong protection from various corrosive external conditions such as salt contamination and air pollution. Moreover, the hydrophilic film keeps water from accumulating on the heat exchanger's fin, minimizing moisture buildup and eventually making it even more corrosion resistant.



Hydrophilic film (Water flow)
The Hydrophilic coating minimizes moisture buildup on the fin.

Acryl + Epoxy + Melamine resin (Corrosion resistant)
The Black coating provides strong protection from corrosion.

Aluminum fin

Lower Global Warming Potential (GWP)

What is GWP?

Global Warming Potential is a measure that allows for an accurate comparison of the environmental impact of different gases. GWP measures how much energy the emissions of 1 ton of a gas will absorb over a given period of time, relative to the emissions of 1 ton of carbon dioxide (CO₂).

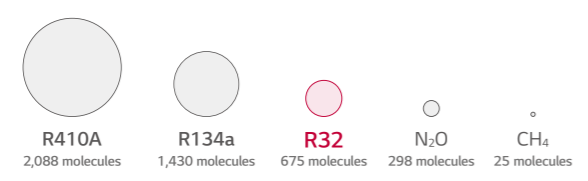

Global Trend and EU Regulation for F-Gas

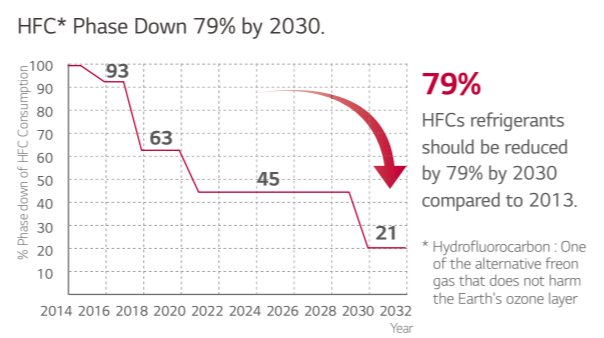

Cost Savings with R32

Higher Efficiency

Savings on cost of energy consumption.



Reduced Equipment Sizes

Savings on product purchase and labor cost for installation and maintenance.



Less Refrigerant Charge

Savings on cost of injecting & replacing refrigerant.



Less Refrigerant Charge

Savings on cost of injecting & replacing refrigerant.



ZRUN040GSS0 / ZRUN050GSS0
ZRUN060GSS0



LG participates in the ECP programme for EUROVENT VRF program. Check ongoing validity of certification : www.eurovent-certification.com

HP			4	5	6
Model Name			ZRUN040GSS0	ZRUN050GSS0	ZRUN060GSS0
Capacity	Cooling (Rated)	kW	12.1	14.0	15.5
	Heating (Rated)	kW	12.1	14.0	15.5
	Heating (Max)	kW	14.2	16.0	18.0
Input	Cooling (Rated)	kW	3.43	3.33	3.97
	Heating (Rated)	kW	2.30	2.72	3.23
	Heating (Max)	kW	2.93	3.48	4.29
EER (Rated)			3.53	4.20	3.90
SEER			8.10	8.70	8.50
COP (Rated)			5.26	5.15	4.80
COP (Max)			4.84	4.60	4.20
SCOP			4.70	4.80	5.00
Exterior	Color		Warm Gray	Warm Gray	Warm Gray
	RAL Code		RAL 7044	RAL 7044	RAL 7044
Heat Exchanger	Type		Wide Louver Plus / Black Fin	Wide Louver Plus / Black Fin	Wide Louver Plus / Black Fin
	Type		LG Inverter Scroll (R1)	LG Inverter Scroll (R1)	LG Inverter Scroll (R1)
Compressor	Combination x No.		(Inverter) x 1	(Inverter) x 1	(Inverter) x 1
	Motor Output x Number	W x No.	3,198 x 1	3,198 x 1	3,198 x 1
	Oil Type		FW68D	FW68D	FW68D
	Oil Charge	cc	1,100	1,100	1,100
	Type		Axial Flow Fan	Axial Flow Fan	Axial Flow Fan
Fan	Motor Output x Number	W x No.	124 x 1	200 x 1	200 x 1
	Air Flow Rate (High)	m ³ /min x No.	60 x 1	80 x 1	80 x 1
	Drive		DC INVERTER	DC INVERTER	DC INVERTER
	Discharge	Side / Top	Side	Side	Side
Pipe Connection	Liquid Pipe	mm (inch)	Ø9.52 (3/8)	Ø9.52 (3/8)	Ø9.52 (3/8)
	Gas Pipe	mm (inch)	Ø15.88 (5/8)	Ø15.88 (5/8)	Ø19.05 (3/4)
Dimensions (W x H x D)			mm x No. (950 x 834 x 330) x 1	mm x No. (950 x 834 x 330) x 1	mm x No. (950 x 834 x 330) x 1
Dimensions (W x H x D) - Shipping			mm x No. (1,147 x 919 x 461) x 1	mm x No. (1,147 x 919 x 461) x 1	mm x No. (1,147 x 919 x 461) x 1
Net Weight			kg x No. 64.7 x 1	kg x No. 71.6 x 1	kg x No. 71.6 x 1
Shipping Weight			kg x No. 73.7 x 1	kg x No. 79.6 x 1	kg x No. 79.6 x 1
Sound Pressure Level	Cooling	dB(A)	50	51	52
	Heating	dB(A)	52	53	54
Sound Power Level	Cooling	dB(A)	67	70	71
	Heating	dB(A)	71	74	75
Communication Cable			mm ² x No. (VCTF-SB) 1.0 - 1.5 x 2C	mm ² x No. (VCTF-SB) 1.0 - 1.5 x 2C	mm ² x No. (VCTF-SB) 1.0 - 1.5 x 2C
Refrigerant	Refrigerant name		R32	R32	R32
	Precharged Amount	kg	1.5	2.0	2.0
	t-CO ₂ eq		1.010	1.350	1.350
	Control		Electronic Expansion Valve	Electronic Expansion Valve	Electronic Expansion Valve
Power Supply			Ø, V, Hz 1, 220-240, 50	Ø, V, Hz 1, 220-240, 50	Ø, V, Hz 1, 220-240, 50
Number of maximum connectable indoor units			8	10	13

Note

- Due to our policy of innovation some specifications may be changed without notification.
- Wiring cable size must comply with the applicable local and national codes. And "Electric characteristics" chapter should be considered for electrical work and design. Especially the power cable and circuit breaker should be selected in accordance with that.
- Sound pressure level is measured on the rated condition in the anechoic rooms by ISO 3745 standard. Sound power level is measured on the rated condition in the reverberation rooms by ISO 3741 standard. Therefore, these values can be increased owing to ambient conditions during operation.
- Performances are based on the following conditions :

- Cooling : Indoor Ambient Temp 27°CDB / 19°CWB, Outdoor Ambient Temp 35°CDB / 24°CWB
- Heating : Indoor Ambient Temp 20°CDB / 15°CWB, Outdoor Ambient Temp 7°CDB / 6°CWB
- Interconnected Pipe Length is 7.5m and difference of Elevation (Outdoor - Indoor Unit) is 0m.
- EUROVENT Test Condition :
- Performance values on the this PDB are based on Ceiling mounted cassette combination.
- Refer to EUROVENT web site(www.eurovent-certification.com) for other indoor unit combination and more detail test conditions.
- The maximum combination ratio is 160%.
- This product contains Fluorinated greenhouse gases. (R32, GWP (Global warming potential) = 675)

ZRUN040LSS0 / ZRUN050LSS0
ZRUN060LSS0



LG participates in the ECP programme for EUROVENT VRF program. Check ongoing validity of certification : www.eurovent-certification.com

HP			4	5	6
Model Name			ZRUN040LSS0	ZRUN050LSS0	ZRUN060LSS0
Capacity	Cooling (Rated)	kW	12.1	14.0	15.5
	Heating (Rated)	kW	12.1	14.0	15.5
	Heating (Max)	kW	14.2	16.0	18.0
Input	Cooling (Rated)	kW	3.43	3.33	3.97
	Heating (Rated)	kW	2.30	2.72	3.23
	Heating (Max)	kW	2.93	3.48	4.29
EER (Rated)			3.53	4.20	3.90
SEER			8.10	8.70	8.50
COP (Rated)			5.26	5.15	4.80
COP (Max)			4.84	4.60	4.20
SCOP			4.70	4.80	5.00
Exterior	Color		Warm Gray	Warm Gray	Warm Gray
	RAL Code		RAL 7044	RAL 7044	RAL 7044
Heat Exchanger	Type		Wide Louver Plus / Black Fin	Wide Louver Plus / Black Fin	Wide Louver Plus / Black Fin
	Type		LG Inverter Scroll (R1)	LG Inverter Scroll (R1)	LG Inverter Scroll (R1)
Compressor	Combination x No.		(Inverter) x 1	(Inverter) x 1	(Inverter) x 1
	Motor Output x Number	W x No.	3,198 x 1	3,198 x 1	3,198 x 1
	Oil Type		FW68D	FW68D	FW68D
	Oil Charge	cc	1,100	1,100	1,100
	Type		Axial Flow Fan	Axial Flow Fan	Axial Flow Fan
Fan	Motor Output x Number	W x No.	124 x 1	200 x 1	200 x 1
	Air Flow Rate (High)	m ³ /min x No.	60 x 1	80 x 1	80 x 1
	Drive		DC INVERTER	DC INVERTER	DC INVERTER
	Discharge	Side / Top	Side	Side	Side
Pipe Connection	Liquid Pipe	mm (inch)	Ø9.52 (3/8)	Ø9.52 (3/8)	Ø9.52 (3/8)
	Gas Pipe	mm (inch)	Ø15.88 (5/8)	Ø15.88 (5/8)	Ø19.05 (3/4)
Dimensions (W x H x D)			mm x No. (950 x 834 x 330) x 1	mm x No. (950 x 834 x 330) x 1	mm x No. (950 x 834 x 330) x 1
Dimensions (W x H x D) - Shipping			mm x No. (1,147 x 919 x 461) x 1	mm x No. (1,147 x 919 x 461) x 1	mm x No. (1,147 x 919 x 461) x 1
Net Weight			kg x No. 64.7 x 1	kg x No. 71.6 x 1	kg x No. 71.6 x 1
Shipping Weight			kg x No. 73.7 x 1	kg x No. 79.6 x 1	kg x No. 79.6 x 1
Sound Pressure Level	Cooling	dB(A)	51	57	57
	Heating	dB(A)	55	60	60
Sound Power Level	Cooling	dB(A)	67	70	71
	Heating	dB(A)	71	74	75
Communication Cable			mm ² x No. (VCTF-SB) 1.0 - 1.5 x 2C	mm ² x No. (VCTF-SB) 1.0 - 1.5 x 2C	mm ² x No. (VCTF-SB) 1.0 - 1.5 x 2C
Refrigerant	Refrigerant name		R32	R32	R32
	Precharged Amount	kg	1.5	2.0	2.0
	t-CO ₂ eq		1.013	1.350	1.350
	Control		Electronic Expansion Valve	Electronic Expansion Valve	Electronic Expansion Valve
Power Supply			Ø, V, Hz 3, 380-415, 50	Ø, V, Hz 3, 380-415, 50	Ø, V, Hz 3, 380-415, 50
Number of maximum connectable indoor units			8	10	13

Note

- Due to our policy of innovation some specifications may be changed without notification.
- Wiring cable size must comply with the applicable local and national codes. And "Electric characteristics" chapter should be considered for electrical work and design. Especially the power cable and circuit breaker should be selected in accordance with that.
- Sound pressure level is measured on the rated condition in the anechoic rooms by ISO 3745 standard. Sound power level is measured on the rated condition in the reverberation rooms by ISO 3741 standard. Therefore, these values can be increased owing to ambient conditions during operation.
- Performances are based on the following conditions :

- Cooling : Indoor Ambient Temp 27°CDB / 19°CWB, Outdoor Ambient Temp 35°CDB / 24°CWB
- Heating : Indoor Ambient Temp 20°CDB / 15°CWB, Outdoor Ambient Temp 7°CDB / 6°CWB
- Interconnected Pipe Length is 7.5m and difference of Elevation (Outdoor - Indoor Unit) is 0m.
- EUROVENT Test Condition :
- Performance values on the this PDB are based on Ceiling mounted cassette combination.
- Refer to EUROVENT web site(www.eurovent-certification.com) for other indoor unit combination and more detail test conditions.
- The maximum combination ratio is 160%.
- This product contains Fluorinated greenhouse gases. (R32, GWP (Global warming potential) = 675)

MULTI V™ M

Highlight

- Air Cooled VRF Heat Pump
- 14kW (Cooling capacity based)
- 3Ø, 380 ~ 415V, 50Hz (Compressor Module)
- 1Ø, 220 ~ 240V, 50Hz (Heat Exchanger Module)
- Outdoor unit is installed inside building

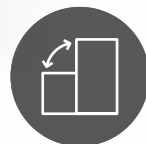

Flexible design



Cost savings



Space savings



Easy maintenance



How does it work?

Direct Inlet / Outlet Case

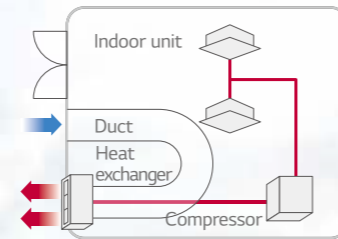

Duct Connected Case

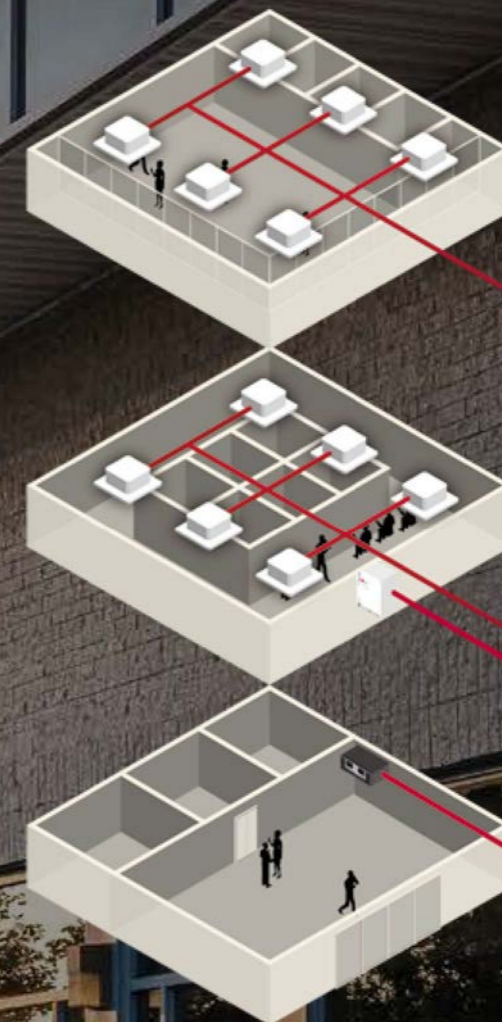
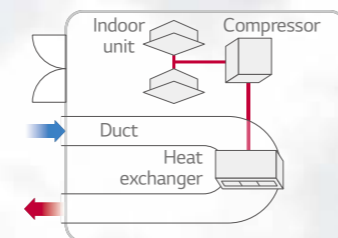

70m
Longest piping length from Compressor Module to Indoor unit

140M
TOTAL PIPING LENGTH

30m
Longest piping length from Heat Exchanger Module to Compressor Module

Energy Efficiency

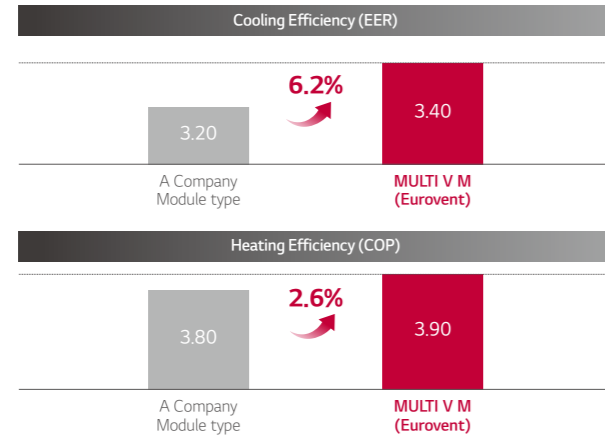

R1 Compressor™

MULTI V M ensures world-class efficiency with innovative technology including R1 Compressor.

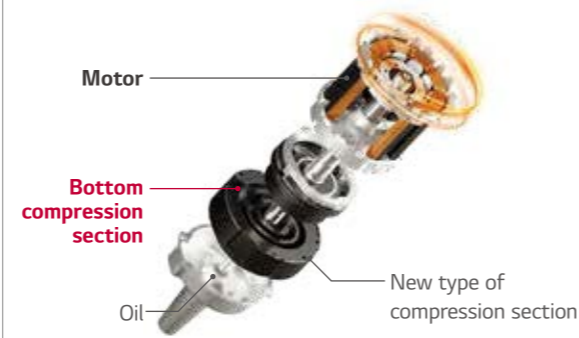

Wide Louver Plus Fin + Corrosion Resistance

Wide Louver Plus fin technology increases efficiency and heating performance compared to conventional fin.

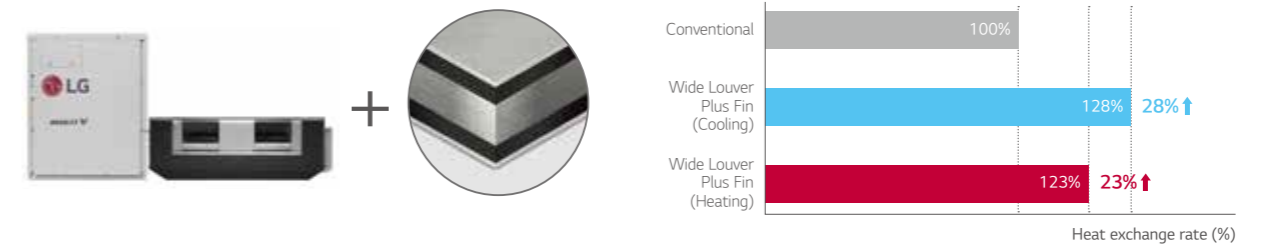

Smart Load Control

To save operation energy consumption, automatically controls the refrigerant temperature according to outdoor temperature.

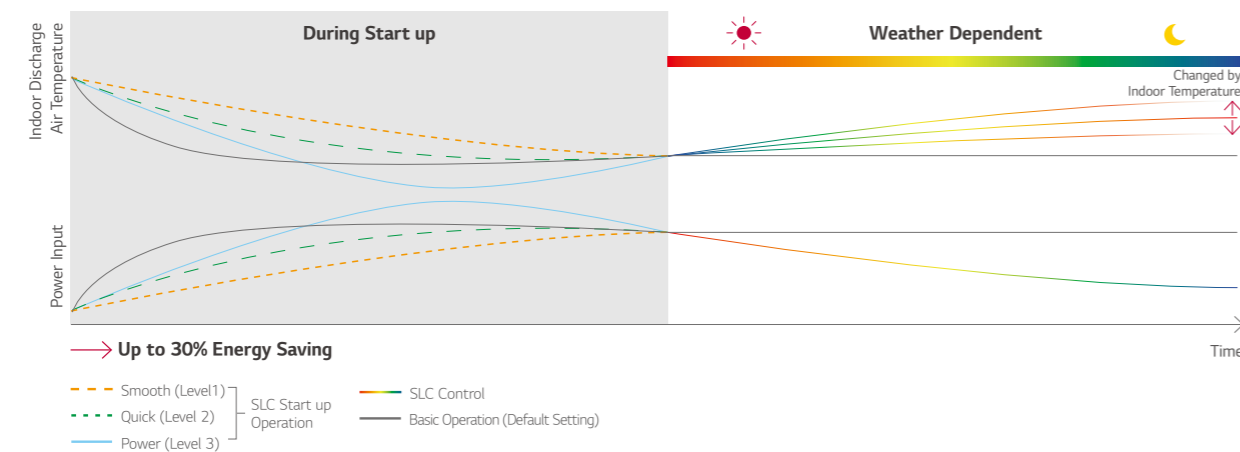
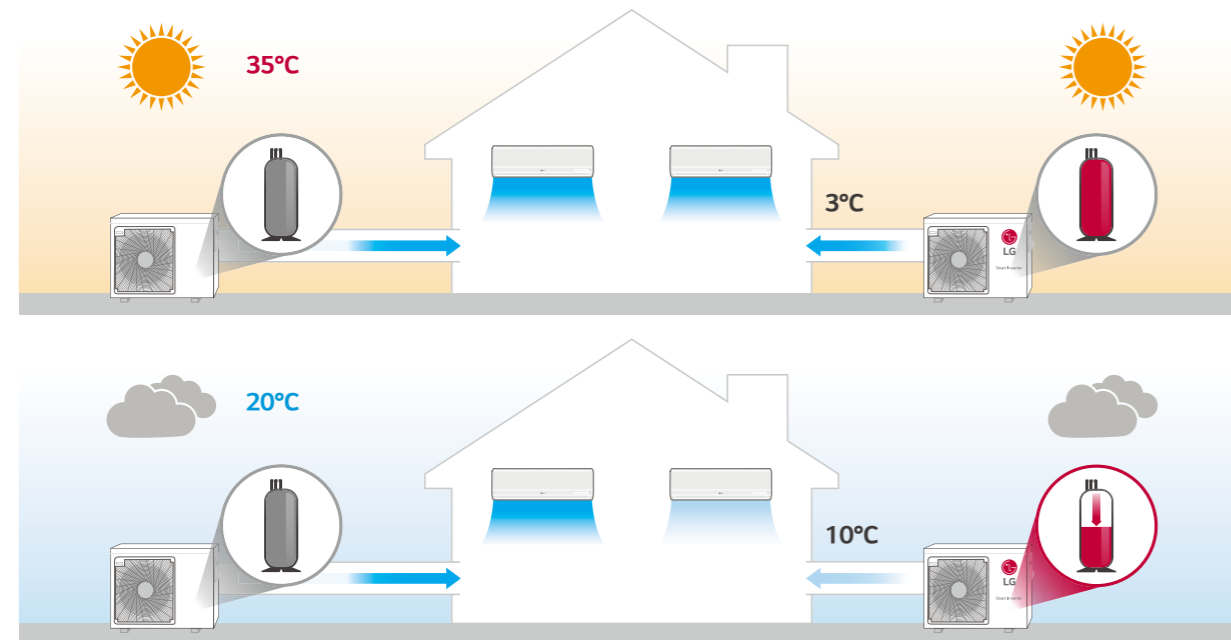

Quiet Operation

Low sound level of both compressor module and heat exchanger module allows outdoor units to be installed and operated inside.

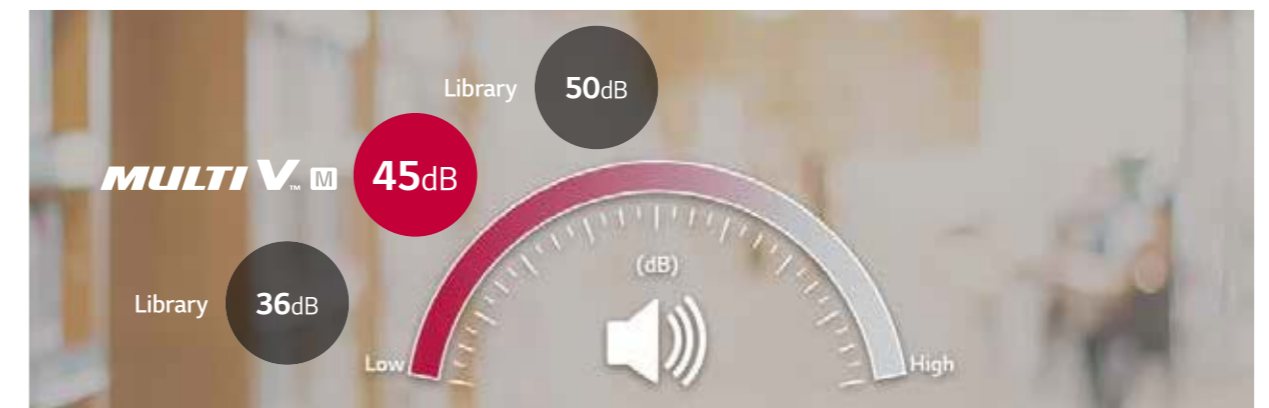

Regulatory Compliance

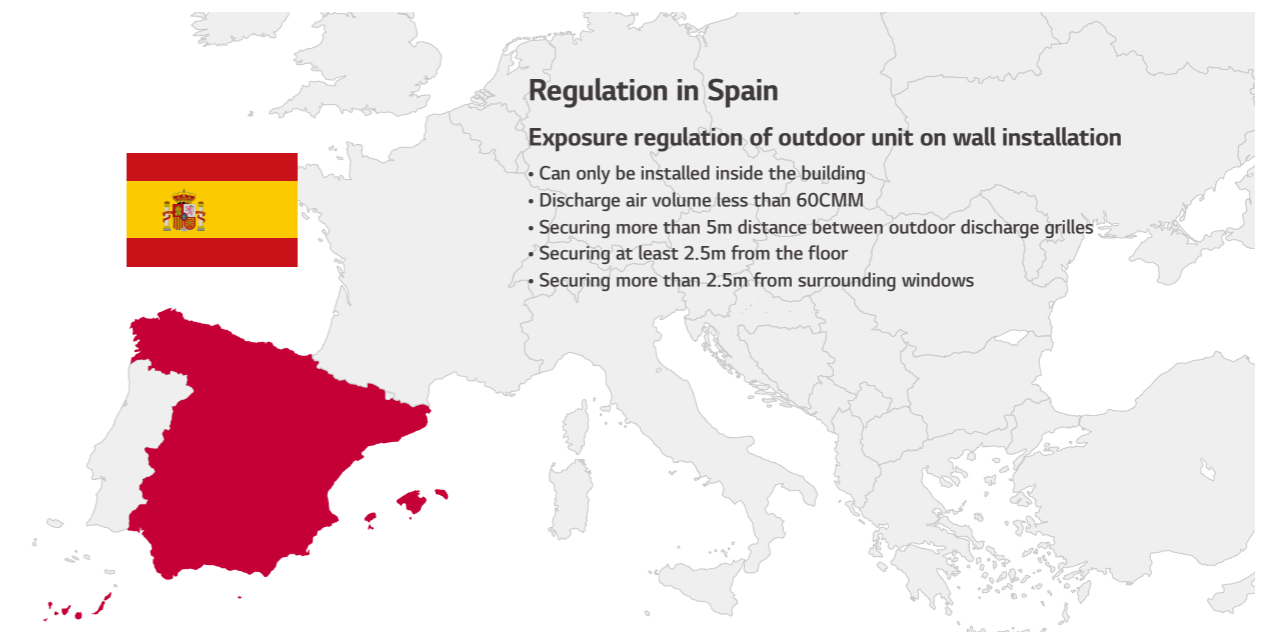

Volume

Compressor Module

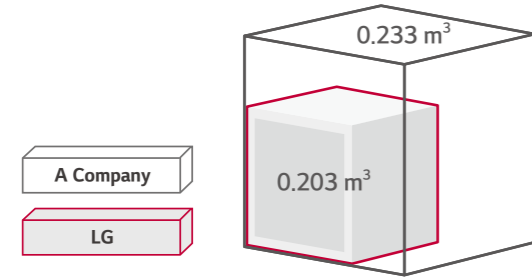

Heat Exchanger Module

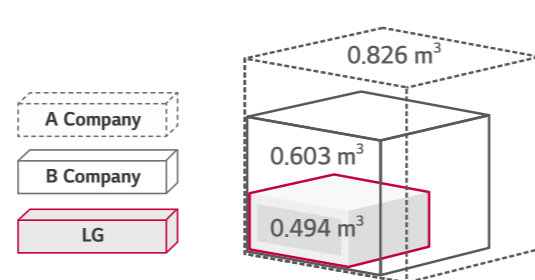

ESP Control

(External Static Pressure)

up to 30 Pa



Normal Mode

up to 157 Pa (max)

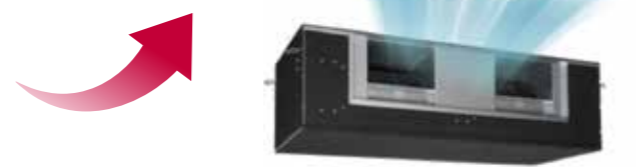

High Static Pressure Mode

Module Type

Increased design freedom

- Additional structure installation and ceiling construction not required
- Ease of service
- Compressor replacement
- Low noise with module
- Ease of service (Replacement of the comp)
- Low noise by module (vs Integrated Type)

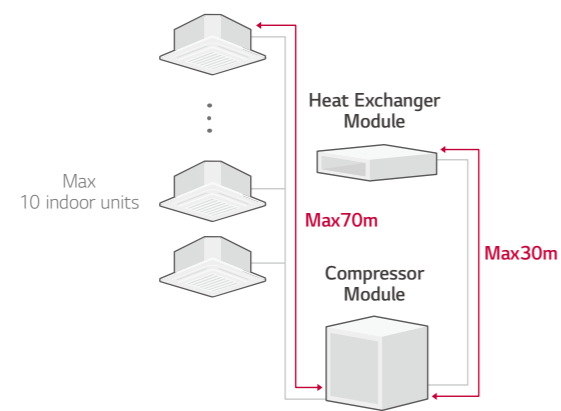

Flexible Piping Location

Tidy & simple installation with flexible piping location.

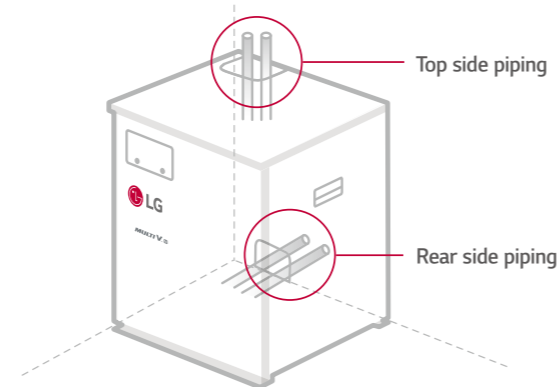

Increased Design Freedom

Additional structure installation nor ceiling construction is required, making compressor replacement and general maintenance easier. Split module provides low noise operation compared to integrated type.



Conventional Outdoor Unit



MULTI V M

Heat exchanger module can be installed in false ceiling spaces

Compressor module can be installed anywhere indoors



Nomenclature

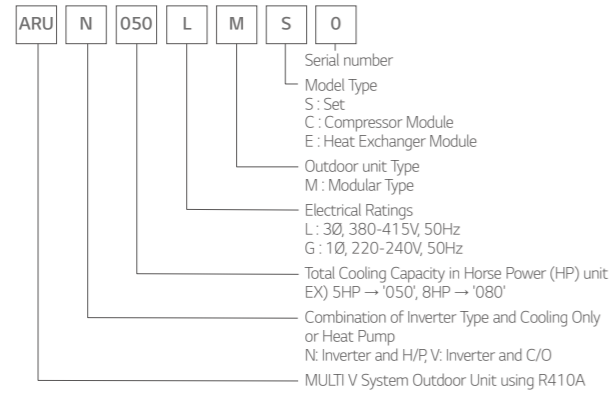

Outdoor Units Function

Category	Functions	Modular
Key Refrigerant Components	Variable Path of Outdoor Unit HEX	-
	HiPOR™ (High Pressure Oil Return)	-
	Humidity Sensor	-
	Corrosion Resistance Black Fin	○
Useful Function	Oil Sensor	-
	Dual Sensing	-
	Low Noise Operation	-
	High Static Mode of Outdoor Unit Fan	○
	Partial Defrosting	-
	Auto Dust Cleaning of Outdoor Unit (Fan reverse rotation)	-
	Indoor Cooling Comfort Mode	-
	Based Outdoor Temperature Smart Load Control (SLC) (Changing indoor discharge air temperature according to load)	○
	Outdoor Unit Control Refer to Humidity	-
	Defrost / Deicing	○
Reliability	High Pressure Switch	○
	Phase Protection	○
	Restart Delay (3-minutes)	○
	Self Diagnosis	○
Central Controller	Soft Start	○
	Test Run Function	-
	AC Ez (Simple Controller)	PQCSZ250S0
	AC Ez Touch	PACEZA000
	AC Smart IV	PACS4B000
BNU (Building Network Unit)	AC Smart 5	PACSSA000
	ACP (Advanced Control Platform) IV	PACP4B000
	ACP (Advanced Control Platform) 5	PACP5A000
	AC Manager 5	PACM5A000
Installation	ACP Lonworks	PLNWKB000
	ACP BACnet	PQNFB17C0
PDI (Power Distribution Indicator)	Refrigerant Charging Kit	-
	Variable Water Flow Valve Control Kit	-
Cool / Heat Selector	Standard	-
	Premium	-
IO Module (ODU Dry Contact)	PRDSBM	-
	PVDSMN000	-
Cycle Monitoring Device	LGMV	PRCTILO
	Mobile LGMV	PLGMVV100

※ ○ : Applied, - : Not Applied

Heat Pump

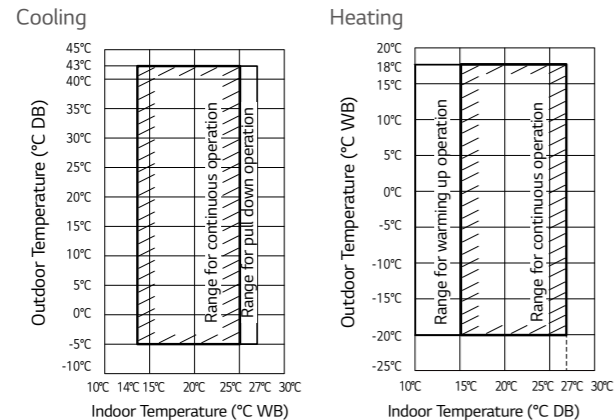

Compressor Module

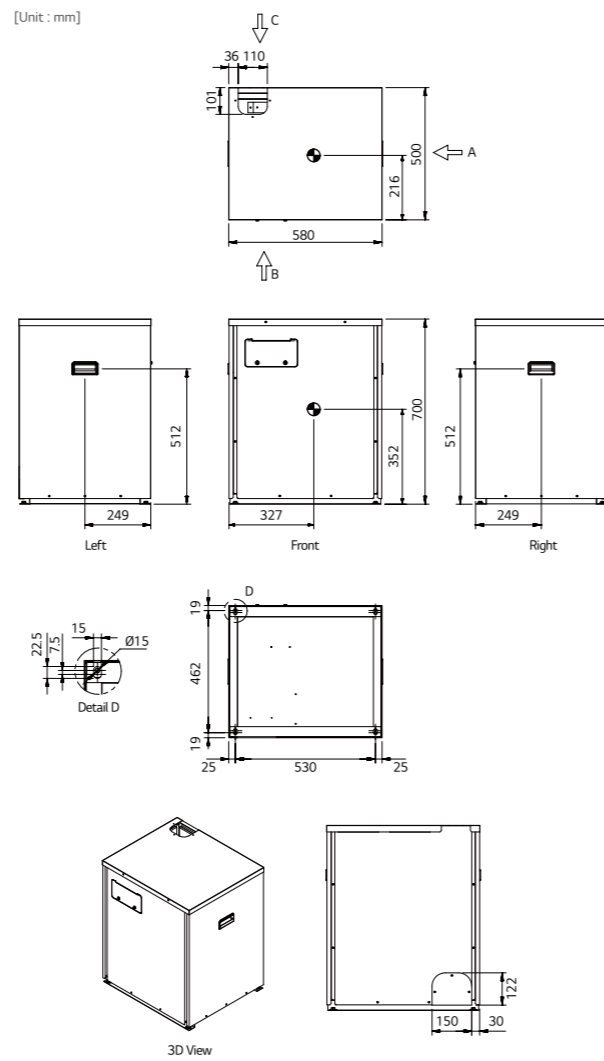

Heat Exchanger Module

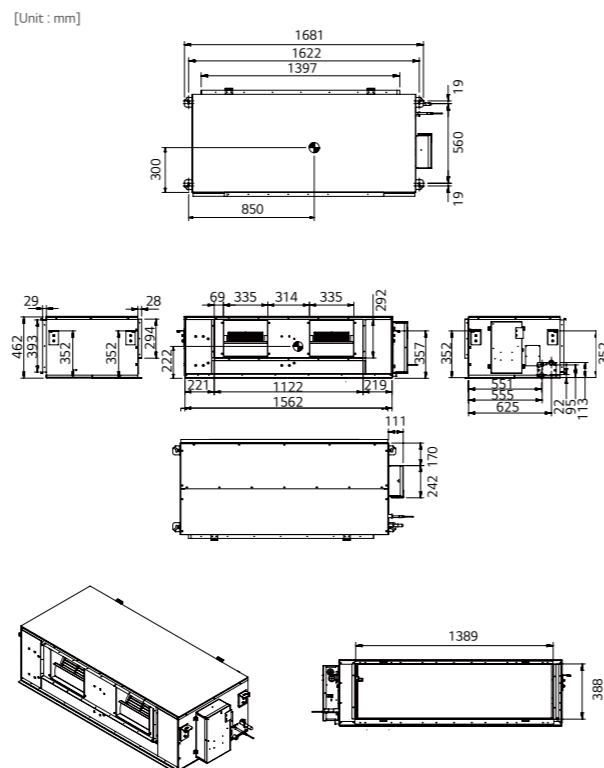

Position of Sound Pressure Level Measuring

Compressor Module

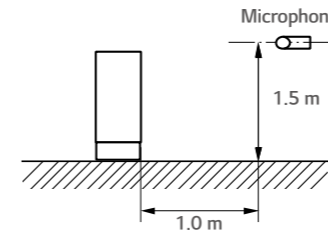

※ Measuring place : Anechoic chamber

Heat Exchanger Module

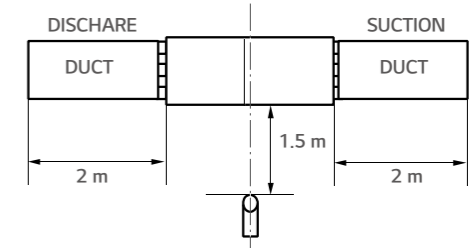

※ Measuring place : Anechoic chamber

Installation Space for Compressor Module

Top View

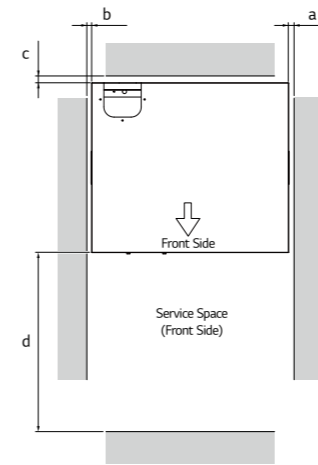

Front View

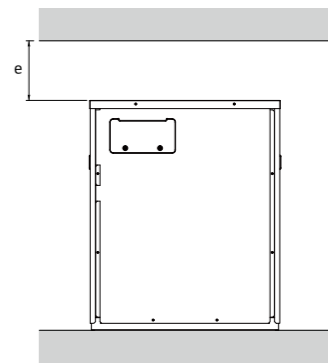

Category	Mark	Description	Installation Space (mm)
Compressor Module	a	Right	10 or More
	b	Left	10 or More
	c	Rear	10 or More
	d	Front	500 or More
	e	Top	200 or More

Installation Space for Heat Exchanger Module

Top View

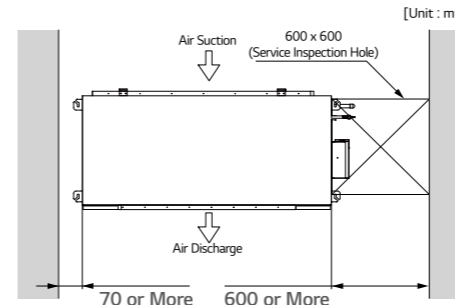

Front View

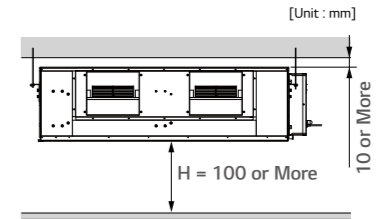

ARUN050LMCO / ARUN050GMEO



LG participates in the ECP programme for EUROVENT VRF program. Check ongoing validity of certification : www.eurovent-certification.com

System

HP		5	
Model Name	Set	ARUN050LMSO	
	Compressor Module	ARUN050LMCO	
	Heat Exchanger Module	ARUN050GMEO	
Capacity	Cooling (Rated) kW	14.0	
	Heating (Rated) kW	14.0	
	Heating (Max) kW	16.0	
Input	Cooling (Rated) kW	4.12	
	Heating (Rated) kW	3.59	
	Heating (Max) kW	4.32	
EER	Based on Rated Capacity	3.40	
SEER		7.03	
COP	Based on Rated Capacity	3.90	
	Based on Max Capacity	3.70	
SCOP		4.12	
Number of Maximum Connectable Indoor Units		10	

※ ○ : Applied, - : Not Applied
Note

- Due to our policy of innovation some specifications may be changed without notification.
- Wiring cable size must comply with the applicable local and national codes. And "Electric characteristics" chapter should be considered for electrical work and design. Especially the power cable and circuit breaker should be selected in accordance with that.
- Power factor could vary less than ±1% according to the operating conditions.
- Sound pressure level is measured on the rated condition in the anechoic rooms by ISO 3745 standard. Sound power level is measured on the rated condition in the reverberation rooms by ISO 3741 standard. Therefore, these values can be increased owing to ambient conditions during operation.
- Performances are based on the following conditions :
 - Cooling : Indoor Ambient Temp 27°CDB / 19°CWB, Outdoor Ambient Temp 35°CDB / 24°CWB
 - Heating : Indoor Ambient Temp 20°CDB / 15°CWB, Outdoor Ambient Temp 7°CDB / 6°CWB
 - Interconnected Pipe Length and Difference of Elevation : - Heat Exchanger Module - Compressor Module = 5m
 - Compressor Module - Indoor Unit = 7.5m
 - Difference of Elevation (Heat Exchanger Module- Compressor Moduler - Indoor Unit) is Zero
- The maximum combination ratio is 130%.
- This product contains Fluorinated greenhouse gases. (R410A, GWP(Global warming potential) = 2,087.5)

ARUN050LMCO / ARUN050GMEO



LG participates in the ECP programme for EUROVENT VRF program. Check ongoing validity of certification : www.eurovent-certification.com

Module

HP		5	
Model Name		Compressor Module	Heat Exchanger Module
		ARUN050LMCO	ARUN050GMEO
Exterior	Color	Morning Gray	-
	RAL Code (Classic)	RAL 7030	-
Dimensions (W x H x D)	Net	mm x No.	580 x 700 x 500
	Shipping	mm x No.	618 x 833 x 564
Weight	Net	kg x No.	69 x 1
	Shipping	kg x No.	76 x 1
Compressor	Type	Hermetic Motor Compressor	
	Combination x No.	(Inverter) x 1	
	Motor Output	W x No.	3,200
	Oil Type	FVC68D (PVE)	
Heat Exchanger	Oil Charge	cc	1,300
	Type	-	Wide Louver Plus / Black Fin
Fan	Type	-	Sirocco Fan
	Motor Output x Number	W x No.	400 x 2
	Air Flow Rate (Rated)	m³/min x No.	60
External Static Pressure	Nominal (Rated, Factory Set)	mmAq (Pa)	3 (29)
	Max	mmAq (Pa)	16 (157)
Pipe Connection	Liquid	mm (inch)	Ø9.52 (3/8) to IDU
	Gas	mm (inch)	Ø15.88 (5/8) to IDU
	Drain	mm (inch)	Ø25 (1)
Sound Pressure Level	Cooling (Rated)	dB(A)	45.0
	Heating (Rated)	dB(A)	45.0
Sound Power Level		dB(A)	59.0
Communication Cable		mm² x No. (VCTF-SB)	1.0 - 1.5 x 2C to IDU
Refrigerant	Refrigerant Name	R410A	
	Precharged Amount	kg	2.0
	t-CO ₂ eq	4.175	
	Control	Electronic Expansion Valve	
Power Supply		Ø, V, Hz	3, 380-415, 50
			1, 220-240, 50

※ ○ : Applied, - : Not Applied
Note

- Due to our policy of innovation some specifications may be changed without notification.
- Wiring cable size must comply with the applicable local and national codes. And "Electric characteristics" chapter should be considered for electrical work and design. Especially the power cable and circuit breaker should be selected in accordance with that.
- Power factor could vary less than ±1% according to the operating conditions.
- Sound pressure level is measured on the rated condition in the anechoic rooms by ISO 3745 standard. Sound power level is measured on the rated condition in the reverberation rooms by ISO 3741 standard. Therefore, these values can be increased owing to ambient conditions during operation.
- Performances are based on the following conditions :
 - Cooling : Indoor Ambient Temp 27°CDB / 19°CWB, Outdoor Ambient Temp 35°CDB / 24°CWB
 - Heating : Indoor Ambient Temp 20°CDB / 15°CWB, Outdoor Ambient Temp 7°CDB / 6°CWB
 - Interconnected Pipe Length and Difference of Elevation : - Heat Exchanger Module - Compressor Module = 5m
 - Compressor Module - Indoor Unit = 7.5m
 - Difference of Elevation (Heat Exchanger Module- Compressor Moduler - Indoor Unit) is Zero
- The maximum combination ratio is 130%.
- This product contains Fluorinated greenhouse gases. (R410A, GWP(Global warming potential) = 2,087.5)

MULTI V™ WATER IV

Highlight

- Water Cooled VRF Heat Pump & Heat Recovery
- 22.4 ~ 201.6kW (Cooling capacity based)
- 3Ø, 380 ~ 415V, 50Hz
- Outdoor unit installed indoor



Energy savings



Space savings



Convenient installation

How does it work?

Operation independent of weather conditions



Available in Heat Pump & Heat Recovery Configuration

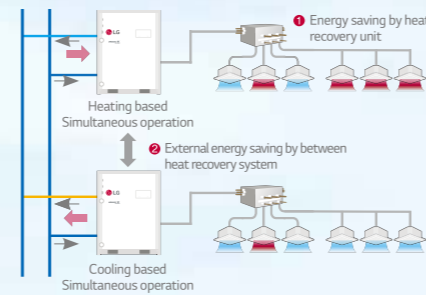

Geothermal Application

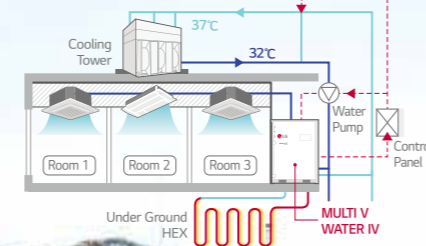

OUTDOOR UNITS

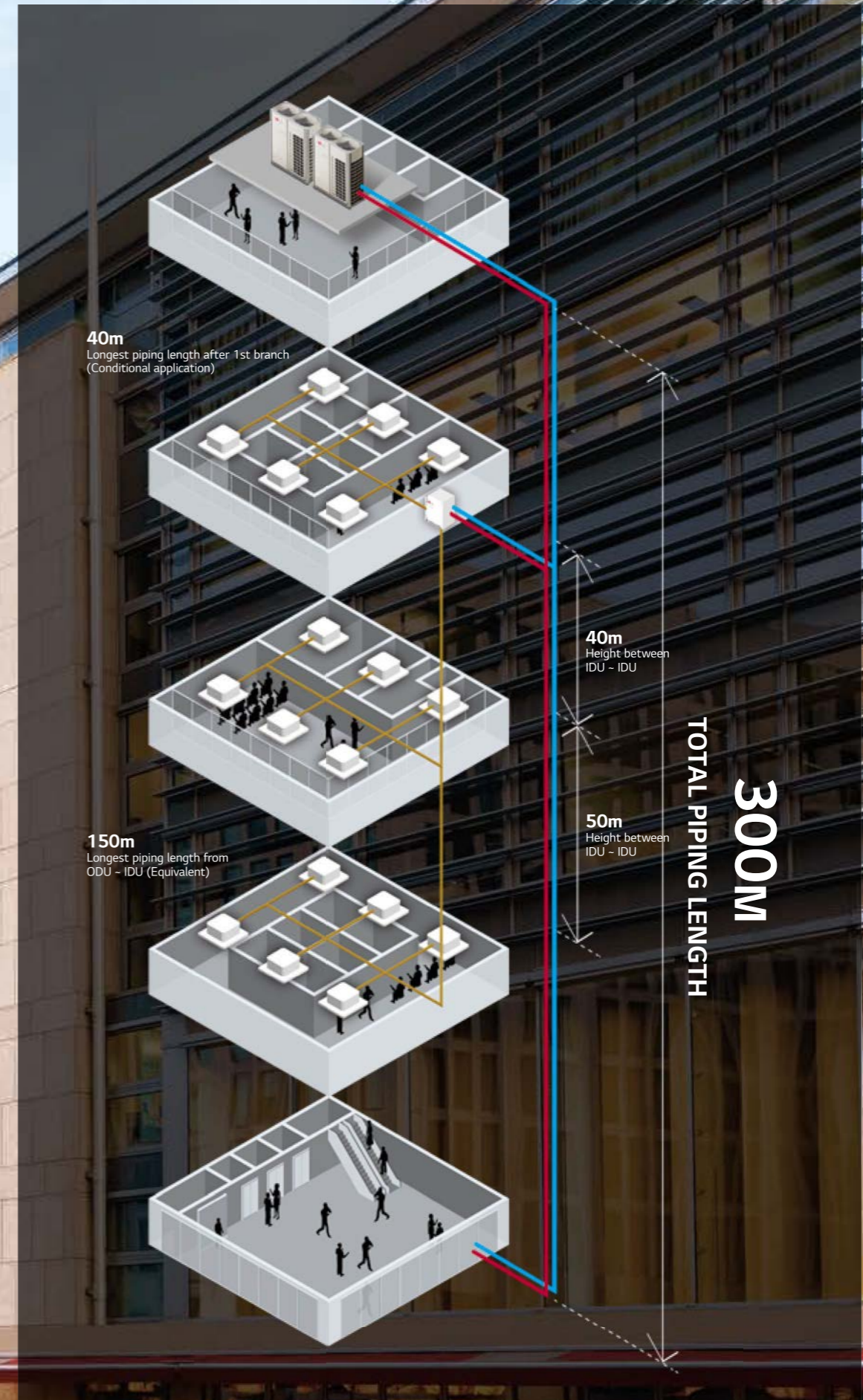

40m
Longest piping length after 1st branch
(Conditional application)

40m
Height between
IDU - IDU

150m
Longest piping length from
ODU - IDU (Equivalent)

50m
Height between
IDU - IDU

TOTAL PIPING LENGTH

300M

High Efficiency System Regardless of External Conditions

Regardless of outdoor temperature and other environmental conditions, MULTI V WATER IV is the optimal solution.

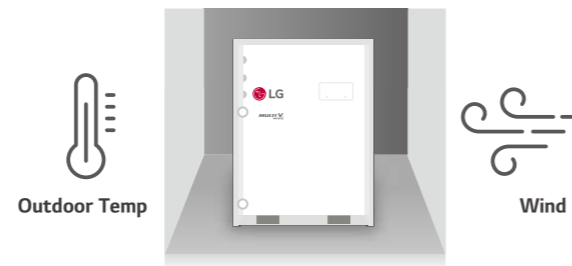

MULTI V WATER IV System for Geothermal Applications

Uses underground heat sources like soil, ground water, lakes, rivers and more as renewable energy for cooling and heating. Water or antifreeze solution is circulated through the closed loop HDPE (High Density Poly-Ethylene) pipes buried beneath the earth's surface.

- The Circulating water temperature range is between -5°C ~ 45°C
- Antifreeze should be applied depending on the application

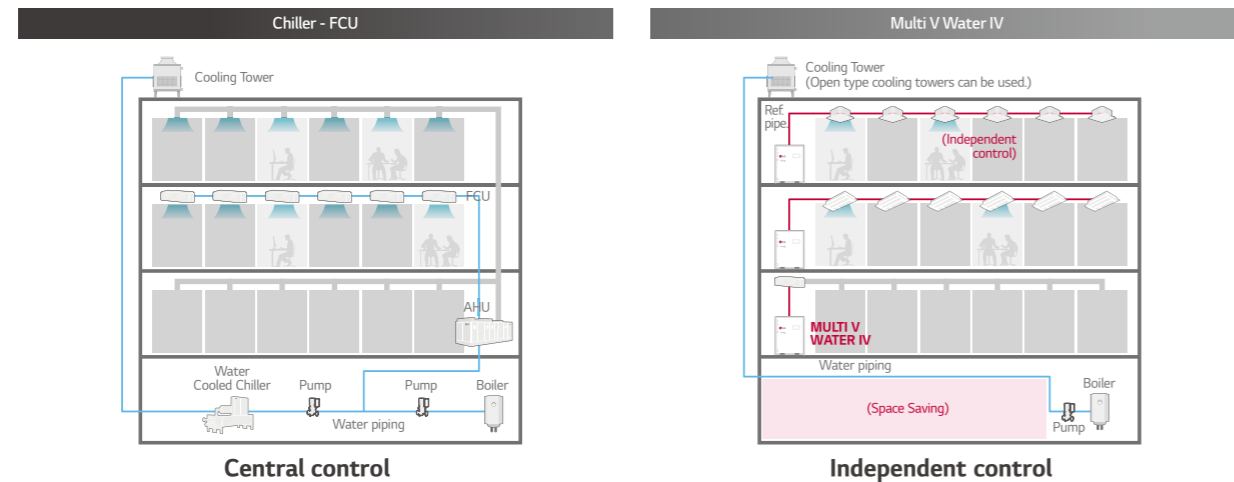
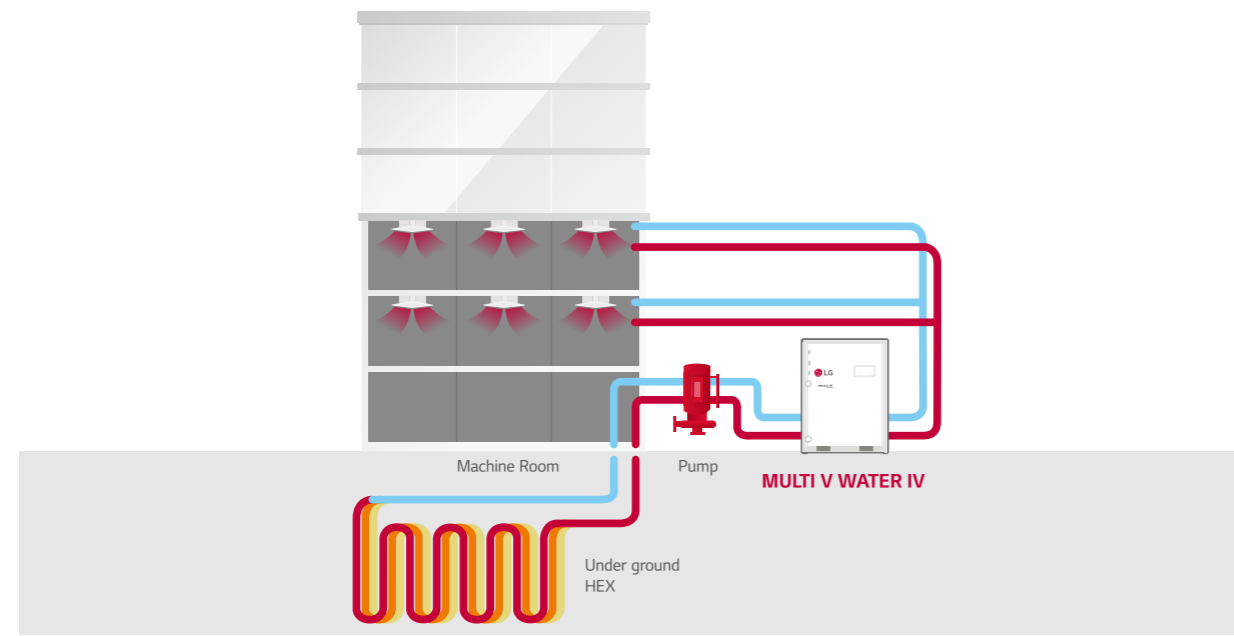

Economical, Highly Efficient System

LG's key technologies are integrated to inverter compressor

With 4th generation inverter compressor, the Multi V Water IV boasts top-class energy efficiency.

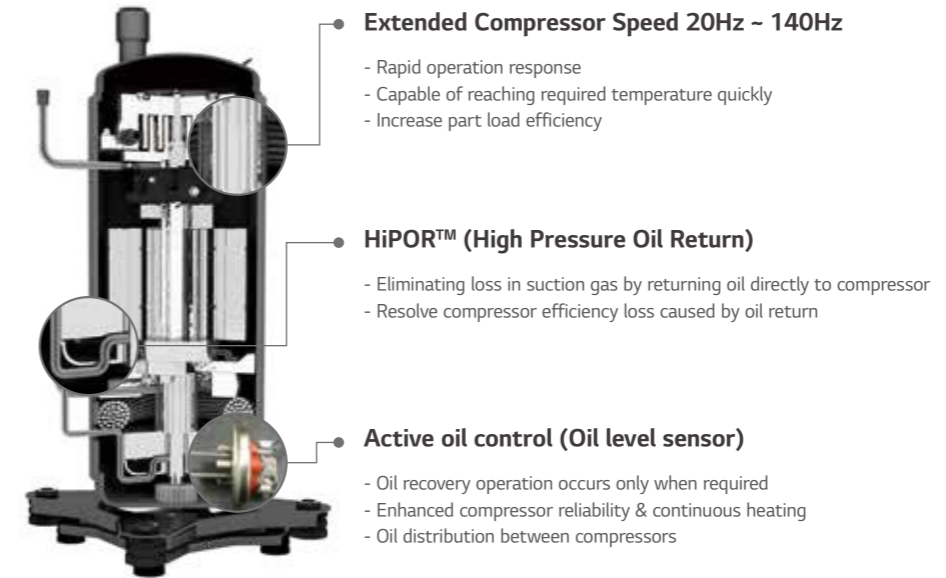

Maximum COP

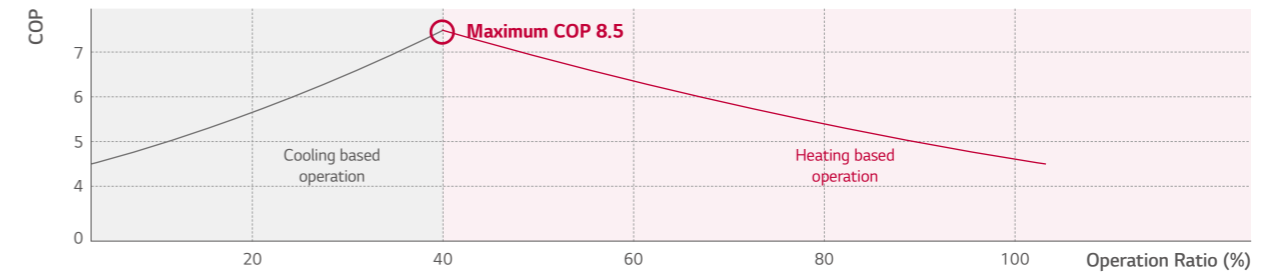

※ Outdoor unit water inlet temperature : 7°C
 ※ Indoor temperature : 20°C DB / 15°C WB
 ※ Maximum COP Condition : Cooling 40% + Heating 60% operation

Economical, Highly Efficient System

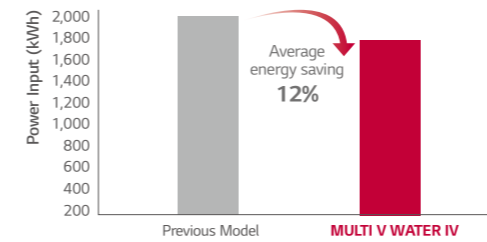

LG's 4th Generation Inverter Compressor

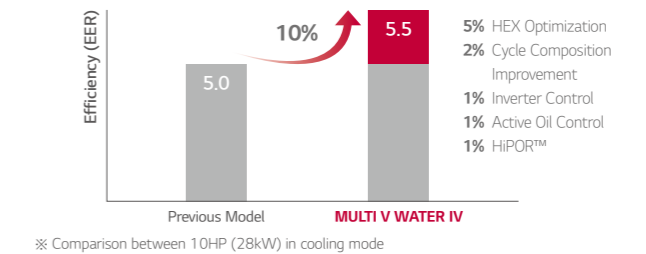

Integrated Part Load Efficiency

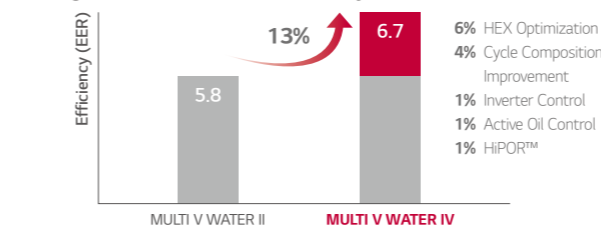

Variable Water Flow Control (OPTION)

In support of green building initiatives

The world's first variable water flow control system for water cooled VRF system. LG applied Variable Water Flow Control to optimize water flow control regarding partial cooling or heating load conditions. Because of this it's also possible to reduce circulation pump energy consumption.

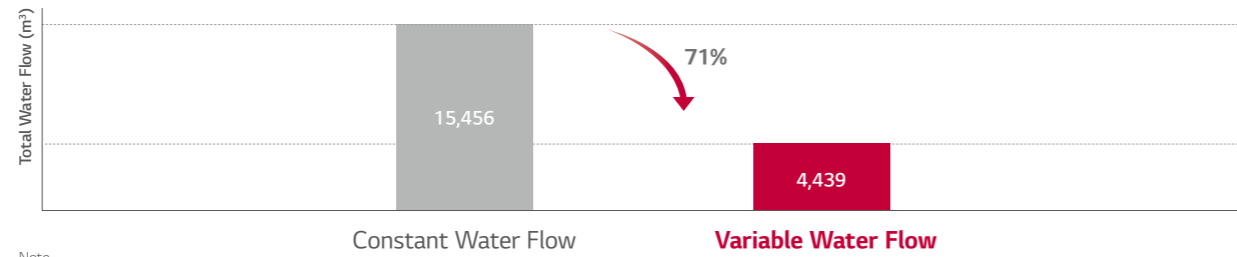
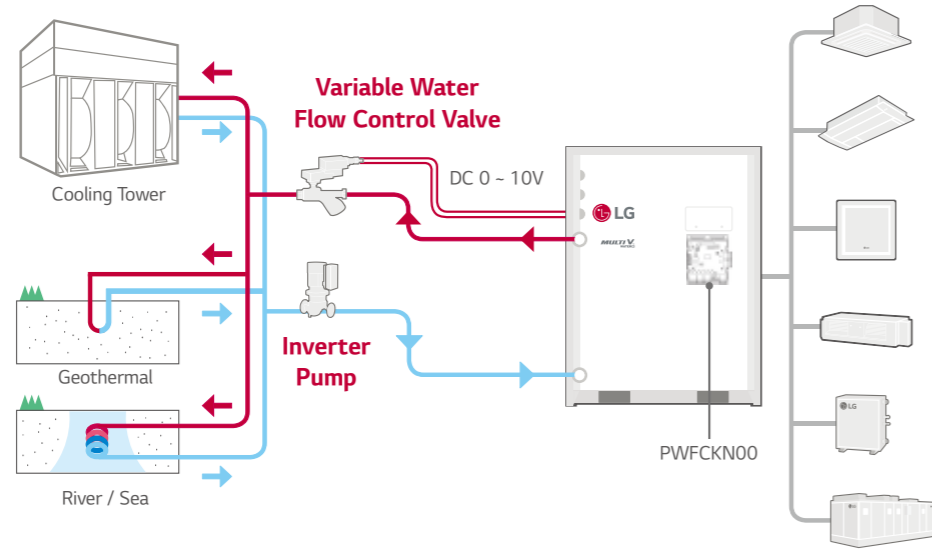

Note
 1. Location : Paris, France
 2. Office, 68,000m²
 3. Operation time : 1,344 hours (Cooling period)

Project Example : 63F (Pump : 20,064 LPM, 42.4mAq x 4ea)

- 1) Inverter pump with MULTI V Water and variable water flow control kit
- 2) Constant pump (Step control) with Water cooled VRF

10 years energy cost (\$)

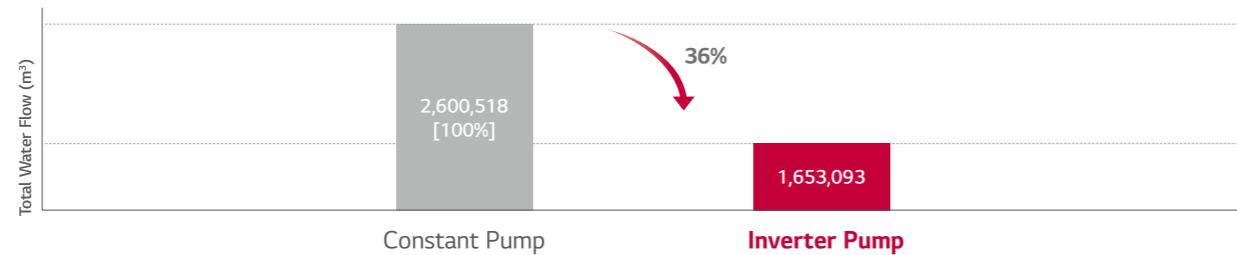

Unit	5 years		10 years	
	Energy Use (kWh)	Pump Running Cost (\$)	Energy Use (kWh)	Pump Running Cost (\$)
Constant pump	7,952,040	1,142,441	15,904,080	2,600,518
Inverter pump	5,054,940	726,225	10,109,880	1,653,093

- Power consumption rate : 0.13\$/kWh
- Annual power consumption rate expected to increase by 5%

Largest Capacity

Sufficient pipe length limitation provides flexible design and installation

Providing 8 ~ 20HP (22.4 ~ 56kW) with single unit, and up to the world's largest capacity 80HP (224kW) by combination.

HP	8	10	14	20	22	24	28	30	34	40	42 ~ 60	62 ~ 80
kW	22.4	28	39.2	56	61.6	67.2	78.4	84	95.2	112	117.6 ~ 168	173.6 ~ 224
LG	1 Unit		2 Units		3 Units		4 Units					

Longest Piping Length

Sufficient pipes length limitation in design and Installation for various buildings

Provide flexible installation up to 300m of total piping length. As water pipes are not connected to indoor units, users are free from water leakage problems.

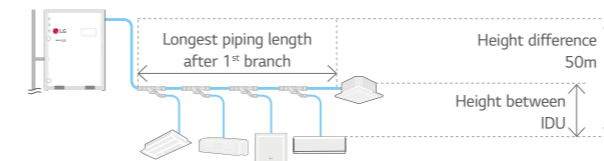

Total Piping Length	300m
Actual longest piping length (Equivalent)	150m (175m)
Longest piping length after 1st branch (Conditional application)	40m (90m)
Height difference between ODU - IDU	50m
Height difference between IDU - IDU	40m

Compact Size

Thanks to compact size of product, it provides more space for commercial or public use as much as possible.

The optimal design of the compact, lightweight outdoor unit enables double stacking, which results in 50% savings in installation space.

Conventional	Multi V Water IV
<p>28kW x 4EA Per each 880 x 550 mm</p> <p>※ 112kW, Floor area based</p>	<p>56kW x 2EA Per each 755 x 500 mm</p> <p>61% Reduced</p> <p>※ 112kW, Floor area based</p>

Lightweight

Nothing or Decrease additional load reinforcement work at building

Easier to transport and install, thanks to 18% reduction in overall weight.

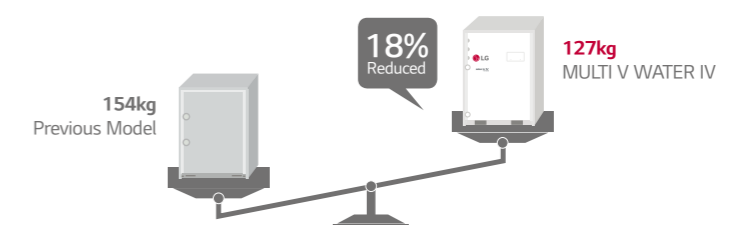

※ Based on 28kW

Nomenclature

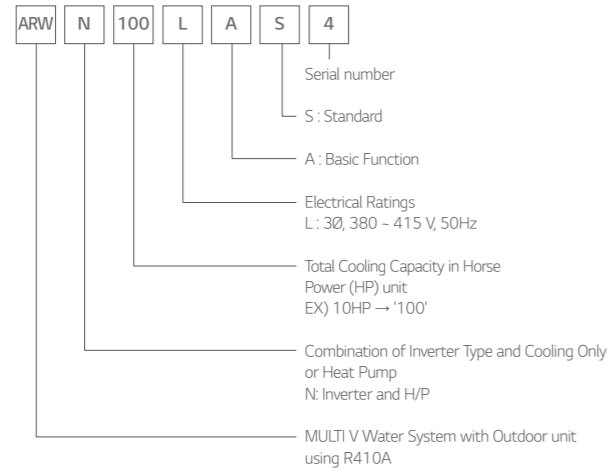

Outdoor Units Function

Category	Functions	Multi V Water IV
Key Refrigerant Components	Variable Path of Outdoor unit HEX	-
	HiPOR™ (High Pressure Oil Return)	○
	Humidity Sensor	-
	Corrosion Resistance Black Fin	-
Useful Function	Oil Sensor	○
	Dual Sensing	-
	Low Noise Operation	-
	High Static Mode of Outdoor Unit Fan	-
Reliability	Partial Defrosting	-
	Auto Dust Cleaning of Outdoor Unit (Fan reverse rotation)	-
	Indoor Cooling Comfort Mode Based Outdoor Temperature	-
	Smart Load Control (SLC) (Changing indoor discharge air temperature according to load)	-
Central Controller	Outdoor Unit Control Refer to Humidity	-
	Defrost / Deicing	-
	High Pressure Switch	○
	Phase Protection	○
Installation	Restart Delay (3-minutes)	○
	Self Diagnosis	○
	Soft Start	○
	AC Ez (Simple Controller)	PQCSZ250S0
PDI (Power Distribution Indicator)	AC Ez Touch	PACEZA000
	AC Smart IV	PACS4B000
	AC Smart 5	PACS5A000
	ACP (Advanced Control Platform) IV	PQCPC22A0
Cool / Heat Selector	ACP (Advanced Control Platform) 5	PACP5A000
	AC Manager 5	PACM5A000
IO Module (ODU Dry Contact)	ACP Lonworks	PLNWKB000
	ACP BACnet	PQNFB17C0
Cycle Monitoring Device	Refrigerant Charging Kit	-
	Variable Water Flow Valve Control Kit	PWFCKN000
Low Ambient Kit	Standard	PPWRDB000
	Premium	PQNUD1S40
IO Module (ODU Dry Contact)	Cool / Heat Selector	PRDSBM
	Low Ambient Kit	-
Cycle Monitoring Device	IO Module (ODU Dry Contact)	PVDSMN000
	LGMV	PRCTILO
Cycle Monitoring Device	Mobile LGMV	PLGMVW100

※ ○ : Applied, - : Not Applied

Operation Limits

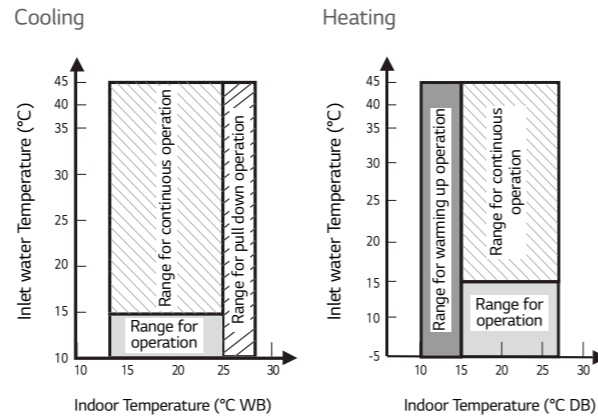

Note
 1. These figures assume the following operating conditions:
 2. Equivalent piping length : 7.5m
 3. Level difference : 0m

Position of Sound Pressure Level Measuring

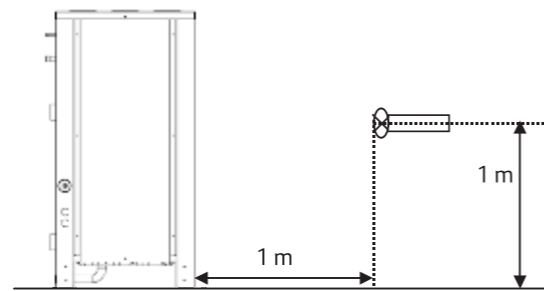

Note
 1. Data is valid at free field condition
 2. Data is valid at nominal operating condition
 3. Sound level will vary depending on a range of factors such as the construction (Acoustic absorption coefficient) of particular room in which the equipment is installed
 4. Sound level can be increased in static pressure mode or air guide application.

Optional Accessories

No.	Name	Model
1	Y branch pipe	ARBLN01621
		ARBLN03321
		ARBLN07121
		ARBLN14521
		ARBLN23220
2	Header	ARBL054
		ARBL057
		ARBL104
		ARBL107
		ARBL1010
3	Connection pipe of Outdoor Units	ARBL2010
		ARCNN21
		ARCNN31
		ARCNN41

Multi V Water IV Heating Dissipation Value by Model

Model	HP	Heating Dissipation Value		
ARWN080LAS4	8	600 W	515.9 kcal/h	0.143 kcal/s
ARWN100LAS4	10	630 W	541.7 kcal/h	0.150 kcal/s
ARWN120LAS4	12	660 W	567.5 kcal/h	0.158 kcal/s
ARWN140LAS4	14	690 W	593.3 kcal/h	0.165 kcal/s
ARWN160LAS4	16	700 W	601.9 kcal/h	0.167 kcal/s
ARWN180LAS4	18	720 W	619.1 kcal/h	0.172 kcal/s
ARWN200LAS4	20	750 W	644.9 kcal/h	0.179 kcal/s

Test condition : Indoor air temperature : DB 40°C, WB : 32°C
 ※ A design stage should be considered to ventilation system in mechanical room.

ARWN080LAS4 / ARWN100LAS4
 ARWN140LAS4 / ARWN200LAS4

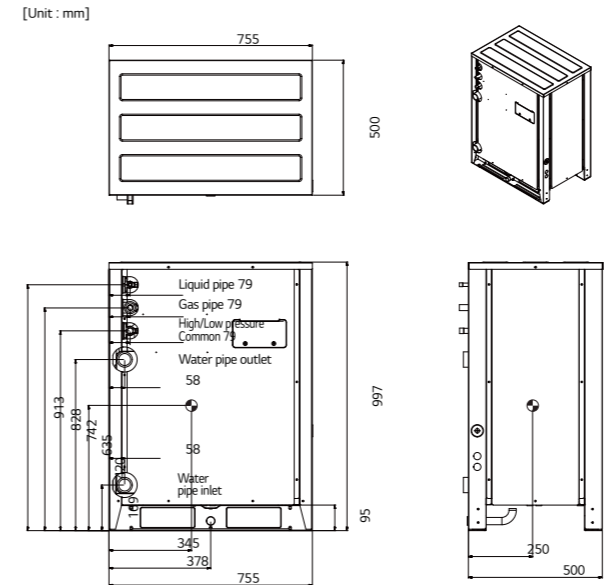

Individual Installation

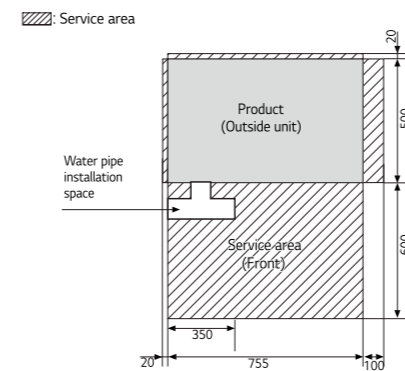

Water Piping Installation

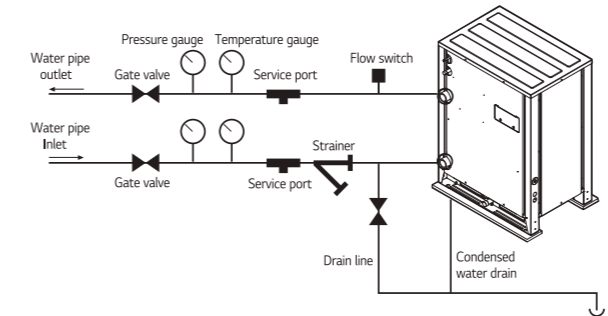

Precaution of Installation

- Do not install the unit at the outdoors. (Installation of the unit outdoors could result in fire or electric shock.) Recommended ambient temperature of outdoor unit is between 0 ~ 40°C.
- Keep the water temperature between 10 ~ 45°C. Standard water supply temperature is 30°C for cooling and 20°C for heating.
- Establish an **anti-freeze plan** for the water supply when the product is stopped during the winter.
- Be careful of the **water purity control**. Ensure water purity control to avoid breakdown due to water pipe corrosion. Refer to 'Standard Table for Water Purity Control' in PDB (Product Data Book).
- The water pressure resistance of the water pipe system of this product is **1.98MPa**.
- Always install a **trap** so that the drained water does not back flush.
- Install a **pressure gauge and temperature gauge** at the inlet and outlet of the water pipe.
- Flexible joints** must be installed not to cause any leakage from the vibration of pipes.
- Install a **service port** to clean the heat exchanger at the each end of the water inlet and outlet.
- It is mandatory to install the **flow switch** to the water collection pipe system connecting to the outdoor unit. (Flow switch acts as the 1st protection device when the heat water is not supplied.)
- When setting the flow switch, it is recommended to use the product with default set value to satisfy the minimum flow rate of this product. (The minimum flow rate range of this product is **50%**)
- To protect the water cooling type product, you must install a **strainer with 50 mesh** or more on the heat water supply pipe. If not installed, it can result in damage of heat exchanger by the following situation.
 - Heat water supply within the plate type heat exchanger is composed of multiple small paths.
 - If you do not use a strainer with 50 mesh or more, alien particles can partially block the water paths.
 - When running the heater, the plate type heat exchanger plays the role of the evaporator, and at this time, the temperature of the refrigerant side drops to drop the temperature of the heat water supply, which can result in icing point in the water paths.
 - As the heating process progresses, the water paths can be partially frozen to lead to damage in plate type heat exchanger.
 - As a result of the damage of the heat exchanger from the freezing, the refrigerant side and the heat water source side will be mixed to make the product unusable.

Bouygues Challenger

LG MULTI V Water Solution with Geothermal Application.



Site Information

The industrial group Bouygues was established in France in 1952. It now maintains operations in 80 countries and employs more than 131,000 people. In 1988, after two years of construction, the new headquarters for Bouygues Construction was officially opened for business. Named Challenger, the complex became a technological showcase for late 20th century architecture.

LG Solution

Bouygues decided to convert their headquarters into an eco-conscious building by significantly reducing its energy footprint. The LG MULTI V Water system was chosen as the ideal HVAC solution for this project. The system not only saves energy but also reduces water usage as it recycles water in order to regulate the temperature of the building. With LG's advanced technology, the building's water consumption was reduced by more than 70 percent.

ARWN080LAS4 / ARWN100LAS4 ARWN140LAS4



HP		8	10	14
Model Name	Combination Unit	ARWN080LAS4	ARWN100LAS4	ARWN140LAS4
	Independent Unit	ARWN080LAS4	ARWN100LAS4	ARWN140LAS4
Capacity	Cooling (Rated) kW	22.4	28.0	39.2
	Heating (Rated) kW	25.2	31.5	44.1
Input	Cooling (Rated) kW	3.86	5.09	7.84
	Heating (Rated) kW	4.2	5.34	8.17
EER		5.80	5.50	5.00
COP	Rated Capacity	6.00	5.90	5.40
Exterior	Color	Warm Gray / Morning Gray	Warm Gray / Morning Gray	Warm Gray / Morning Gray
	RAL Code (Classic)	RAL 7044 / RAL 7030	RAL 7044 / RAL 7030	RAL 7044 / RAL 7030
Heat Exchanger	Type	Stainless Steel Plate	Stainless Steel Plate	Stainless Steel Plate
	Maximum Pressure Resistance	kgf/cm ²	45	45
	Head Loss	kPa	10.7	15.8
	Rated Water Flow	LPM	77	96
Compressor	Type	Hermetically Sealed Scroll	Hermetically Sealed Scroll	Hermetically Sealed Scroll
	Combination x No.	(Inverter) x 1	(Inverter) x 1	(Inverter) x 1
	Motor Output x Number	W x No.	4,200 x 1	4,200 x 1
	Oil Type	FVC68D (PVE)	FVC68D (PVE)	FVC68D (PVE)
Refrigerant Connecting Pipes	Liquid Pipe	mm (inch)	Ø9.52 (3/8)	Ø9.52 (3/8)
	Gas Pipe	mm (inch)	Ø22.2 (7/8)	Ø22.2 (7/8)
Water Connecting Pipes	Inlet	A (inch)	40A (PT 1-1/2) (Internal Thread)	40A (PT 1-1/2) (Internal Thread)
	Outlet	A (inch)	40A (PT 1-1/2) (Internal Thread)	40A (PT 1-1/2) (Internal Thread)
	Drain Outlet	A (inch)	20A (PT 3/4) (External Thread)	20A (PT 3/4) (External Thread)
Dimensions (W x H x D)	mm x No.	(755 x 997 x 500) x 1	(755 x 997 x 500) x 1	(755 x 997 x 500) x 1
Dimensions (W x H x D) - Shipping	mm x No.	(804 x 1,143 x 630) x 1	(804 x 1,143 x 630) x 1	(804 x 1,143 x 630) x 1
Net Weight	kg x No.	127 x 1	127 x 1	127 x 1
Shipping Weight	kg x No.	137 x 1	137 x 1	137 x 1
Sound Pressure Level	Cooling	dB(A)	47	50
	Heating	dB(A)	51	53
Sound Power Level	Cooling	dB(A)	59	62
	Heating	dB(A)	63	65
Communication Cable	mm ² x No. (VCTF-SB)	1.0 - 1.5 x 2C	1.0 - 1.5 x 2C	1.0 - 1.5 x 2C
Refrigerant	Refrigerant Name		R410A	R410A
	Precharged Amount in Factory	kg	5.8	5.8
	t-CO ₂ eq		12.108	12.108
	Control		Electronic Expansion Valve	Electronic Expansion Valve
Power Supply	Ø, V, Hz	3, 380-415, 50	3, 380-415, 50	3, 380-415, 50
Number of Maximum Connectable Indoor Units		13 (20)	16 (25)	23 (35)

Note

- Maximum numbers are prepared based on assumption that all 2.2kW indoor units are connected. The numbers in parentheses means maximum connectable indoor units in accordance with outdoor units combination (160% - 200%). The recommended ratio is 130%.
- Due to our policy of innovation some specifications may be changed without notification.
- Performances are based on the following conditions:
 - Cooling : Indoor temp 27°C (80.6°F) DB / 19°C (66.2°F) WB, Water inlet temp 30°C (86°F)
 - Heating : Indoor temp 20°C (68°F) DB, Water inlet temp 20°C (68°F)
 - Interconnected Pipe Length is 7.5m and difference of Elevation (Outdoor - Indoor Unit) is 0m.
- Sound pressure level is measured on the rated condition in the anechoic rooms by ISO 3745 standard. Sound power level is measured on the rated condition in the reverberation rooms by ISO 3741 standard. Therefore, these values can be increased owing to ambient conditions during operation.
- This product contains Fluorinated Greenhouse Gases. (R410A, GWP (Global warming potential) = 2,087.5)
- Add an anti freeze to circulation water when outdoor unit is operating under 10°C (50°F), and change the DIP switch on main PCB. (For more information on installation section.)

ARWN200LAS4 / ARWN160LAS4
ARWN180LAS4



HP		20	16	18	
Model Name	Combination Unit	ARWN200LAS4	ARWN160LAS4	ARWN180LAS4	
	Independent Unit	ARWN200LAS4	ARWN080LAS4 ARWN080LAS4	ARWN100LAS4 ARWN080LAS4	
Capacity	Cooling (Rated) kW	56.0	44.8	50.4	
	Heating (Rated) kW	63.0	50.4	56.7	
Input	Cooling (Rated) kW	11.20	7.72	8.95	
	Heating (Rated) kW	11.67	8.40	9.54	
EER		5.00	5.80	5.63	
COP	Rated Capacity	5.40	6.00	5.94	
Exterior	Color	Warm Gray / Morning Gray	Warm Gray / Morning Gray	Warm Gray / Morning Gray	
	RAL Code (Classic)	RAL 7044 / RAL 7030	RAL 7044 / RAL 7030	RAL 7044 / RAL 7030	
Heat Exchanger	Type	Stainless Steel Plate	Stainless Steel Plate	Stainless Steel Plate	
	Maximum Pressure Resistance	kgf/cm ²	45	45	
	Head Loss	kPa	30.1	10.7 + 10.7	15.8 + 10.7
	Rated Water Flow	LPM	192	77 + 77	96 + 77
Compressor	Type	Hermetically Sealed Scroll	Hermetically Sealed Scroll	Hermetically Sealed Scroll	
	Combination x No.	(Inverter) x 1	(Inverter) x 2	(Inverter) x 2	
	Motor Output x Number	W x No.	5,300 x 1	4,200 x 2	4,200 x 2
	Oil Type	FVC68D (PVE)	FVC68D (PVE)	FVC68D (PVE)	
	Oil Charge	cc	3,000	5,600	5,600
Refrigerant Connecting Pipes	Liquid Pipe	mm (inch)	Ø12.7 (1/2)	Ø12.7 (1/2)	Ø12.7 (1/2)
	Gas Pipe	mm (inch)	Ø28.58 (1-1/8)	Ø28.58 (1-1/8)	Ø28.58 (1-1/8)
Water Connecting Pipes	Inlet	A (inch)	40A (PT 1-1/2) (Internal Thread)	40A (PT 1-1/2) + 40A (PT 1-1/2) (Internal Thread)	40A (PT 1-1/2) + 40A (PT 1-1/2) (Internal Thread)
	Outlet	A (inch)	40A (PT 1-1/2) (Internal Thread)	40A (PT 1-1/2) + 40A (PT 1-1/2) (Internal Thread)	40A (PT 1-1/2) + 40A (PT 1-1/2) (Internal Thread)
	Drain Outlet	A (inch)	20A (PT 3/4) (External Thread)	20A (PT 3/4) (External Thread)	20A (PT 3/4) (External Thread)
Dimensions (W x H x D)	mm x No.	(755 x 997 x 500) x 1	(755 x 997 x 500) x 2	(755 x 997 x 500) x 2	
Dimensions (W x H x D) - Shipping	mm x No.	(804 x 1,143 x 630) x 1	(804 x 1,143 x 630) x 2	(804 x 1,143 x 630) x 2	
Net Weight	kg x No.	140 x 1	127 x 2	127 x 2	
Shipping Weight	kg x No.	150 x 1	137 x 2	137 x 2	
Sound Pressure Level	Cooling	dB(A)	54	50	52
	Heating	dB(A)	60	54	55
Sound Power Level	Cooling	dB(A)	66	62	64
	Heating	dB(A)	72	66	67
Communication Cable	mm ² x No. (VCTF-SB)	1.0 - 1.5 x 2C	1.0 - 1.5 x 2C	1.0 - 1.5 x 2C	
Refrigerant	Refrigerant Name		R410A	R410A	R410A
	Precharged Amount in Factory	kg	3.0	11.6	11.6
	t-CO ₂ eq		6.263	24.215	24.215
	Control		Electronic Expansion Valve	Electronic Expansion Valve	Electronic Expansion Valve
Power Supply	Ø, V, Hz	3, 380-415, 50	3, 380-415, 50	3, 380-415, 50	
Number of Maximum Connectable Indoor Units		32 (50)	26 (40)	29 (45)	

- Note
- Maximum numbers are prepared based on assumption that all 2.2kW indoor units are connected. The numbers in parentheses means maximum connectable indoor units in accordance with outdoor units combination (160% - 200%). The recommended ratio is 130%.
 - Due to our policy of innovation some specifications may be changed without notification
 - Performances are based on the following conditions
 - Cooling : Indoor temp 27°C (80.6°F) DB / 19°C (66.2°F) WB, Water inlet temp 30°C (86°F)
 - Heating : Indoor temp 20°C (68°F) DB, Water inlet temp 20°C (68°F)
 - Interconnected Pipe Length is 7.5m and difference of Elevation (Outdoor - Indoor Unit) is 0m.
 - Sound pressure level is measured on the rated condition in the anechoic rooms by ISO 3745 standard. Sound power level is measured on the rated condition in the reverberation rooms by ISO 3741 standard. Therefore, these values can be increased owing to ambient conditions during operation.
 - This product contains Fluorinated Greenhouse Gases. (R410A, GWP (Global warming potential) = 2,087.5)
 - Add an anti freeze to circulation water when outdoor unit is operating under 10°C (50°F), and change the DIP switch on main PCB. (For more information on installation section.)

ARWN220LAS4 / ARWN240LAS4
ARWN280LAS4



HP		22	24	28	
Model Name	Combination Unit	ARWN220LAS4	ARWN240LAS4	ARWN280LAS4	
	Independent Unit	ARWN140LAS4 ARWN080LAS4	ARWN140LAS4 ARWN100LAS4	ARWN140LAS4 ARWN100LAS4	
Capacity	Cooling (Rated) kW	61.6	67.2	78.4	
	Heating (Rated) kW	69.3	75.6	88.2	
Input	Cooling (Rated) kW	11.70	12.93	15.68	
	Heating (Rated) kW	12.37	13.51	16.34	
EER		5.26	5.20	5.00	
COP	Rated Capacity	5.60	5.60	5.40	
Exterior	Color	Warm Gray / Morning Gray	Warm Gray / Morning Gray	Warm Gray / Morning Gray	
	RAL Code (Classic)	RAL 7044 / RAL 7030	RAL 7044 / RAL 7030	RAL 7044 / RAL 7030	
Heat Exchanger	Type	Stainless Steel Plate	Stainless Steel Plate	Stainless Steel Plate	
	Maximum Pressure Resistance	kgf/cm ²	45	45	
	Head Loss	kPa	28.6 + 10.7	28.6 + 15.8	28.6 + 28.6
	Rated Water Flow	LPM	135 + 77	135 + 96	135 + 135
Compressor	Type	Hermetically Sealed Scroll	Hermetically Sealed Scroll	Hermetically Sealed Scroll	
	Combination x No.	(Inverter) x 2	(Inverter) x 2	(Inverter) x 2	
	Motor Output x Number	W x No.	4,200 x 2	4,200 x 2	4,200 x 2
	Oil Type	FVC68D (PVE)	FVC68D (PVE)	FVC68D (PVE)	
	Oil Charge	cc	5,600	5,600	5,600
Refrigerant Connecting Pipes	Liquid Pipe	mm (inch)	Ø19.05 (3/4)	Ø19.05 (3/4)	Ø19.05 (3/4)
	Gas Pipe	mm (inch)	Ø34.9 (1-3/8)	Ø34.9 (1-3/8)	Ø34.9 (1-3/8)
Water Connecting Pipes	Inlet	A (inch)	40A (PT 1-1/2) + 40A (PT 1-1/2) (Internal Thread)	40A (PT 1-1/2) + 40A (PT 1-1/2) (Internal Thread)	40A (PT 1-1/2) + 40A (PT 1-1/2) (Internal Thread)
	Outlet	A (inch)	40A (PT 1-1/2) + 40A (PT 1-1/2) (Internal Thread)	40A (PT 1-1/2) + 40A (PT 1-1/2) (Internal Thread)	40A (PT 1-1/2) + 40A (PT 1-1/2) (Internal Thread)
	Drain Outlet	A (inch)	20A (PT 3/4) (External Thread)	20A (PT 3/4) (External Thread)	20A (PT 3/4) (External Thread)
Dimensions (W x H x D)	mm x No.	(755 x 997 x 500) x 2	(755 x 997 x 500) x 2	(755 x 997 x 500) x 2	
Dimensions (W x H x D) - Shipping	mm x No.	(804 x 1,143 x 630) x 2	(804 x 1,143 x 630) x 2	(804 x 1,143 x 630) x 2	
Net Weight	kg x No.	127 x 2	127 x 2	127 x 2	
Shipping Weight	kg x No.	137 x 2	137 x 2	137 x 2	
Sound Pressure Level	Cooling	dB(A)	58	59	59
	Heating	dB(A)	58	58	58
Sound Power Level	Cooling	dB(A)	70	71	72
	Heating	dB(A)	70	70	71
Communication Cable	mm ² x No. (VCTF-SB)	1.0 - 1.5 x 2C	1.0 - 1.5 x 2C	1.0 - 1.5 x 2C	
Refrigerant	Refrigerant Name		R410A	R410A	R410A
	Precharged Amount in Factory	kg	11.6	11.6	11.6
	t-CO ₂ eq		24.215	24.215	24.215
	Control		Electronic Expansion Valve	Electronic Expansion Valve	Electronic Expansion Valve
Power Supply	Ø, V, Hz	3, 380-415, 50	3, 380-415, 50	3, 380-415, 50	
Number of Maximum Connectable Indoor Units		35 (44)	39 (48)	45 (56)	

- Note
- Maximum numbers are prepared based on assumption that all 2.2kW indoor units are connected. The numbers in parentheses means maximum connectable indoor units in accordance with outdoor units combination (160% - 200%). The recommended ratio is 130%.
 - Due to our policy of innovation some specifications may be changed without notification
 - Performances are based on the following conditions
 - Cooling : Indoor temp 27°C (80.6°F) DB / 19°C (66.2°F) WB, Water inlet temp 30°C (86°F)
 - Heating : Indoor temp 20°C (68°F) DB, Water inlet temp 20°C (68°F)
 - Interconnected Pipe Length is 7.5m and difference of Elevation (Outdoor - Indoor Unit) is 0m.
 - Sound pressure level is measured on the rated condition in the anechoic rooms by ISO 3745 standard. Sound power level is measured on the rated condition in the reverberation rooms by ISO 3741 standard. Therefore, these values can be increased owing to ambient conditions during operation.
 - This product contains Fluorinated Greenhouse Gases. (R410A, GWP (Global warming potential) = 2,087.5)
 - Add an anti freeze to circulation water when outdoor unit is operating under 10°C (50°F), and change the DIP switch on main PCB. (For more information on installation section.)

**ARWN300LAS4 / ARWN340LAS4
ARWN400LAS4**



HP		30	34	40	
Model Name	Combination Unit	ARWN300LAS4	ARWN340LAS4	ARWN400LAS4	
	Independent Unit	ARWN200LAS4 ARWN100LAS4	ARWN200LAS4 ARWN140LAS4	ARWN200LAS4 ARWN140LAS4	
Capacity	Cooling (Rated) kW	84.0	95.2	112.0	
	Heating (Rated) kW	94.5	107.1	126.0	
Input	Cooling (Rated) kW	16.29	19.04	22.40	
	Heating (Rated) kW	17.01	19.84	23.34	
EER		5.16	5.00	5.00	
COP	Rated Capacity	5.56	5.40	5.40	
Exterior	Color	Warm Gray / Morning Gray	Warm Gray / Morning Gray	Warm Gray / Morning Gray	
	RAL Code (Classic)	RAL 7044 / RAL 7030	RAL 7044 / RAL 7030	RAL 7044 / RAL 7030	
Heat Exchanger	Type	Stainless Steel Plate	Stainless Steel Plate	Stainless Steel Plate	
	Maximum Pressure Resistance	kgf/cm ²	45	45	
	Head Loss	kPa	30.1 + 15.8	30.1 + 28.6	30.1 + 30.1
	Rated Water Flow	LPM	192 + 96	192 + 135	192 + 192
Compressor	Type	Hermetically Sealed Scroll	Hermetically Sealed Scroll	Hermetically Sealed Scroll	
	Combination x No.	(Inverter) x 2	(Inverter) x 2	(Inverter) x 2	
	Motor Output x Number	W x No.	5,300 x 1 + 4,200 x 1	5,300 x 1 + 4,200 x 1	5,300 x 2
	Oil Type	FVC68D (PVE)	FVC68D (PVE)	FVC68D (PVE)	
	Oil Charge	cc	5,800	5,800	6,000
Refrigerant Connecting Pipes	Liquid Pipe	mm (inch)	Ø19.05 (3/4)	Ø19.05 (3/4)	Ø19.05 (3/4)
	Gas Pipe	mm (inch)	Ø34.9 (1-3/8)	Ø34.9 (1-3/8)	Ø41.3 (1-5/8)
Water Connecting Pipes	Inlet	A (inch)	40A (PT 1-1/2) + 40A (PT 1-1/2) (Internal Thread)	40A (PT 1-1/2) + 40A (PT 1-1/2) (Internal Thread)	40A (PT 1-1/2) + 40A (PT 1-1/2) (Internal Thread)
	Outlet	A (inch)	40A (PT 1-1/2) + 40A (PT 1-1/2) (Internal Thread)	40A (PT 1-1/2) + 40A (PT 1-1/2) (Internal Thread)	40A (PT 1-1/2) + 40A (PT 1-1/2) (Internal Thread)
	Drain Outlet	A (inch)	20A (PT 3/4) (External Thread)	20A (PT 3/4) (External Thread)	20A (PT 3/4) (External Thread)
Dimensions (W x H x D)	mm x No.	(755 x 997 x 500) x 2	(755 x 997 x 500) x 2	(755 x 997 x 500) x 2	
Dimensions (W x H x D) - Shipping	mm x No.	(804 x 1,143 x 630) x 2	(804 x 1,143 x 630) x 2	(804 x 1,143 x 630) x 2	
Net Weight	kg x No.	(140 x 1) + (127 x 1)	(140 x 1) + (127 x 1)	140 x 2	
Shipping Weight	kg x No.	(150 x 1) + (137 x 1)	(150 x 1) + (137 x 1)	150 x 2	
Sound Pressure Level	Cooling	dB(A)	55	59	55
	Heating	dB(A)	61	61	61
Sound Power Level	Cooling	dB(A)	67	72	68
	Heating	dB(A)	73	74	74
Communication Cable	mm ² x No. (VCTF-SB)	1.0 - 1.5 x 2C	1.0 - 1.5 x 2C	1.0 - 1.5 x 2C	
Refrigerant	Refrigerant Name	R410A	R410A	R410A	
	Precharged Amount in Factory	kg	8.8	8.8	6.0
	t-CO ₂ eq		18.370	18.370	12.525
	Control		Electronic Expansion Valve	Electronic Expansion Valve	Electronic Expansion Valve
Power Supply	Ø, V, Hz	3, 380-415, 50	3, 380-415, 50	3, 380-415, 50	
Number of Maximum Connectable Indoor Units		49 (60)	55 (64)	64	

Note
 1. Maximum numbers are prepared based on assumption that all 2.2kW indoor units are connected. The numbers in parentheses means maximum connectable indoor units in accordance with outdoor units combination (160% - 200%). The recommended ratio is 130%.
 2. Due to our policy of innovation some specifications may be changed without notification.
 3. Performances are based on the following conditions
 - Cooling : Indoor temp 27°C (80.6°F) DB / 19°C (66.2°F) WB, Water inlet temp 30°C (86°F)
 - Heating : Indoor temp 20°C (68°F) DB, Water inlet temp 20°C (68°F)
 - Interconnected Pipe Length is 7.5m and difference of Elevation (Outdoor - Indoor Unit) is 0m.
 4. Sound pressure level is measured on the rated condition in the anechoic rooms by ISO 3745 standard. Sound power level is measured on the rated condition in the reverberation rooms by ISO 3741 standard. Therefore, these values can be increased owing to ambient conditions during operation.
 5. This product contains Fluorinated Greenhouse Gases. (R410A, GWP (Global warming potential) = 2,087.5)
 6. Add an anti freeze to circulation water when outdoor unit is operating under 10°C (50°F), and change the DIP switch on main PCB. (For more information on installation section.)

**ARWN420LAS4 / ARWN440LAS4
ARWN480LAS4**



HP		42	44	48	
Model Name	Combination Unit	ARWN420LAS4	ARWN440LAS4	ARWN480LAS4	
	Independent Unit	ARWN200LAS4 ARWN140LAS4 ARWN080LAS4	ARWN200LAS4 ARWN140LAS4 ARWN100LAS4	ARWN200LAS4 ARWN140LAS4 ARWN140LAS4	
Capacity	Cooling (Rated) kW	117.6	123.2	134.4	
	Heating (Rated) kW	132.3	138.6	151.2	
Input	Cooling (Rated) kW	22.9	24.13	26.88	
	Heating (Rated) kW	24.04	25.18	28.01	
EER		5.14	5.11	5.00	
COP	Rated Capacity	5.50	5.50	5.40	
Exterior	Color	Warm Gray / Morning Gray	Warm Gray / Morning Gray	Warm Gray / Morning Gray	
	RAL Code (Classic)	RAL 7044 / RAL 7030	RAL 7044 / RAL 7030	RAL 7044 / RAL 7030	
Heat Exchanger	Type	Stainless Steel Plate	Stainless Steel Plate	Stainless Steel Plate	
	Maximum Pressure Resistance	kgf/cm ²	45	45	
	Head Loss	kPa	30.1 + 28.6 + 10.7	30.1 + 28.6 + 15.8	30.1 + 28.6 + 28.6
	Rated Water Flow	LPM	192 + 135 + 77	192 + 135 + 96	192 + 135 + 135
Compressor	Type	Hermetically Sealed Scroll	Hermetically Sealed Scroll	Hermetically Sealed Scroll	
	Combination x No.	(Inverter) x 3	(Inverter) x 3	(Inverter) x 3	
	Motor Output x Number	W x No.	5,300 x 1 + 4,200 x 2	5,300 x 1 + 4,200 x 2	5,300 x 1 + 4,200 x 2
	Oil Type	FVC68D (PVE)	FVC68D (PVE)	FVC68D (PVE)	
	Oil Charge	cc	8,600	8,600	8,600
Refrigerant Connecting Pipes	Liquid Pipe	mm (inch)	Ø19.05 (3/4)	Ø19.05 (3/4)	Ø19.05 (3/4)
	Gas Pipe	mm (inch)	Ø41.3 (1-5/8)	Ø41.3 (1-5/8)	Ø41.3 (1-5/8)
Water Connecting Pipes	Inlet	A (inch)	40A (PT 1-1/2) + 40A (PT 1-1/2) + 40A (PT 1-1/2) (Internal Thread)	40A (PT 1-1/2) + 40A (PT 1-1/2) + 40A (PT 1-1/2) (Internal Thread)	40A (PT 1-1/2) + 40A (PT 1-1/2) + 40A (PT 1-1/2) (Internal Thread)
	Outlet	A (inch)	40A (PT 1-1/2) + 40A (PT 1-1/2) + 40A (PT 1-1/2) (Internal Thread)	40A (PT 1-1/2) + 40A (PT 1-1/2) + 40A (PT 1-1/2) (Internal Thread)	40A (PT 1-1/2) + 40A (PT 1-1/2) + 40A (PT 1-1/2) (Internal Thread)
	Drain Outlet	A (inch)	20A (PT 3/4) (External Thread)	20A (PT 3/4) (External Thread)	20A (PT 3/4) (External Thread)
Dimensions (W x H x D)	mm x No.	(755 x 997 x 500) x 3	(755 x 997 x 500) x 3	(755 x 997 x 500) x 3	
Dimensions (W x H x D) - Shipping	mm x No.	(804 x 1,143 x 630) x 3	(804 x 1,143 x 630) x 3	(804 x 1,143 x 630) x 3	
Net Weight	kg x No.	(140 x 1) + (127 x 2)	(140 x 1) + (127 x 2)	(140 x 1) + (127 x 2)	
Shipping Weight	kg x No.	(150 x 1) + (137 x 2)	(150 x 1) + (137 x 2)	(150 x 1) + (137 x 2)	
Sound Pressure Level	Cooling	dB(A)	60	60	60
	Heating	dB(A)	62	62	62
Sound Power Level	Cooling	dB(A)	72	72	74
	Heating	dB(A)	74	74	76
Communication Cable	mm ² x No. (VCTF-SB)	1.0 - 1.5 x 2C	1.0 - 1.5 x 2C	1.0 - 1.5 x 2C	
Refrigerant	Refrigerant Name	R410A	R410A	R410A	
	Precharged Amount in Factory	kg	14.6	14.6	14.6
	t-CO ₂ eq		30.478	30.478	30.478
	Control		Electronic Expansion Valve	Electronic Expansion Valve	Electronic Expansion Valve
Power Supply	Ø, V, Hz	3, 380-415, 50	3, 380-415, 50	3, 380-415, 50	
Number of Maximum Connectable Indoor Units		64	64	64	

Note
 1. Maximum numbers are prepared based on assumption that all 2.2kW indoor units are connected. The numbers in parentheses means maximum connectable indoor units in accordance with outdoor units combination (160% - 200%). The recommended ratio is 130%.
 2. Due to our policy of innovation some specifications may be changed without notification.
 3. Performances are based on the following conditions
 - Cooling : Indoor temp 27°C (80.6°F) DB / 19°C (66.2°F) WB, Water inlet temp 30°C (86°F)
 - Heating : Indoor temp 20°C (68°F) DB, Water inlet temp 20°C (68°F)
 - Interconnected Pipe Length is 7.5m and difference of Elevation (Outdoor - Indoor Unit) is 0m.
 4. Sound pressure level is measured on the rated condition in the anechoic rooms by ISO 3745 standard. Sound power level is measured on the rated condition in the reverberation rooms by ISO 3741 standard. Therefore, these values can be increased owing to ambient conditions during operation.
 5. This product contains Fluorinated Greenhouse Gases. (R410A, GWP (Global warming potential) = 2,087.5)
 6. Add an anti freeze to circulation water when outdoor unit is operating under 10°C (50°F), and change the DIP switch on main PCB. (For more information on installation section.)

ARWN500LAS4 / ARWN540LAS4
ARWN600LAS4



HP			50	54	60
Model Name	Combination Unit		ARWN500LAS4	ARWN540LAS4	ARWN600LAS4
	Independent Unit		ARWN200LAS4 ARWN200LAS4 ARWN100LAS4	ARWN200LAS4 ARWN200LAS4 ARWN140LAS4	ARWN200LAS4 ARWN200LAS4 ARWN200LAS4
Capacity	Cooling (Rated)	kW	140.0	151.2	168.0
	Heating (Rated)	kW	157.5	170.1	189.0
Input	Cooling (Rated)	kW	27.49	30.24	33.60
	Heating (Rated)	kW	28.68	31.51	35.01
EER			5.09	5.00	5.00
COP	Rated Capacity		5.49	5.40	5.40
Exterior	Color		Warm Gray / Morning Gray	Warm Gray / Morning Gray	Warm Gray / Morning Gray
	RAL Code (Classic)		RAL 7044 / RAL 7030	RAL 7044 / RAL 7030	RAL 7044 / RAL 7030
Heat Exchanger	Type		Stainless Steel Plate	Stainless Steel Plate	Stainless Steel Plate
	Maximum Pressure Resistance	kgf/cm ²	45	45	45
	Head Loss	kPa	30.1 + 30.1 + 15.8	30.1 + 28.6 + 28.6	30.1 + 30.1 + 30.1
	Rated Water Flow	LPM	192 + 192 + 96	192 + 192 + 135	192 + 192 + 192
Compressor	Type		Hermetically Sealed Scroll	Hermetically Sealed Scroll	Hermetically Sealed Scroll
	Combination x No.		(Inverter) x 3	(Inverter) x 3	(Inverter) x 3
	Motor Output x Number	W x No.	5,300 x 2 + 4,200 x 1	5,300 x 2 + 4,200 x 1	5,300 x 3
	Oil Type		FVC68D (PVE)	FVC68D (PVE)	FVC68D (PVE)
	Oil Charge	cc	8,800	8,800	9,000
Refrigerant Connecting Pipes	Liquid Pipe	mm (inch)	Ø19.05 (3/4)	Ø19.05 (3/4)	Ø19.05 (3/4)
	Gas Pipe	mm (inch)	Ø41.3 (1-5/8)	Ø41.3 (1-5/8)	Ø41.3 (1-5/8)
Water Connecting Pipes	Inlet	A (inch)	40A (PT 1-1/2) + 40A (PT 1-1/2) + 40A (PT 1-1/2) (Internal Thread)	40A (PT 1-1/2) + 40A (PT 1-1/2) + 40A (PT 1-1/2) (Internal Thread)	40A (PT 1-1/2) + 40A (PT 1-1/2) + 40A (PT 1-1/2) (Internal Thread)
	Outlet	A (inch)	40A (PT 1-1/2) + 40A (PT 1-1/2) + 40A (PT 1-1/2) (Internal Thread)	40A (PT 1-1/2) + 40A (PT 1-1/2) + 40A (PT 1-1/2) (Internal Thread)	40A (PT 1-1/2) + 40A (PT 1-1/2) + 40A (PT 1-1/2) (Internal Thread)
	Drain Outlet	A (inch)	20A (PT 3/4) (External Thread)	20A (PT 3/4) (External Thread)	20A (PT 3/4) (External Thread)
Dimensions (W x H x D)	mm x No.		(755 x 997 x 500) x 3	(755 x 997 x 500) x 3	(755 x 997 x 500) x 3
Dimensions (W x H x D) - Shipping	mm x No.		(804 x 1,143 x 630) x 3	(804 x 1,143 x 630) x 3	(804 x 1,143 x 630) x 3
Net Weight	kg x No.		(140 x 2) + (127 x 1)	(140 x 2) + (127 x 1)	140 x 3
Shipping Weight	kg x No.		(150 x 2) + (137 x 1)	(150 x 2) + (137 x 1)	150 x 3
Sound Pressure Level	Cooling	dB(A)	58	60	56
	Heating	dB(A)	63	62	62
Sound Power Level	Cooling	dB(A)	70	74	70
	Heating	dB(A)	75	76	76
Communication Cable	mm ² x No. (VCTF-SB)		1.0 - 1.5 x 2C	1.0 - 1.5 x 2C	1.0 - 1.5 x 2C
Refrigerant	Refrigerant Name		R410A	R410A	R410A
	Precharged Amount in Factory	kg	11.8	11.8	9.0
	t-CO ₂ eq		24.633	24.633	18.788
	Control		Electronic Expansion Valve	Electronic Expansion Valve	Electronic Expansion Valve
Power Supply	Ø, V, Hz		3, 380-415, 50	3, 380-415, 50	3, 380-415, 50
Number of Maximum Connectable Indoor Units			64	64	64

- Note
- Maximum numbers are prepared based on assumption that all 2.2kW indoor units are connected. The numbers in parentheses means maximum connectable indoor units in accordance with outdoor units combination (160% - 200%). The recommended ratio is 130%.
 - Due to our policy of innovation some specifications may be changed without notification
 - Performances are based on the following conditions
 - Cooling : Indoor temp 27°C (80.6°F) DB / 19°C (66.2°F) WB, Water inlet temp 30°C (86°F)
 - Heating : Indoor temp 20°C (68°F) DB, Water inlet temp 20°C (68°F)
 - Interconnected Pipe Length is 7.5m and difference of Elevation (Outdoor - Indoor Unit) is 0m.
 - Sound pressure level is measured on the rated condition in the anechoic rooms by ISO 3745 standard. Sound power level is measured on the rated condition in the reverberation rooms by ISO 3741 standard. Therefore, these values can be increased owing to ambient conditions during operation.
 - This product contains Fluorinated Greenhouse Gases. (R410A, GWP (Global warming potential) = 2,087.5)
 - Add an anti freeze to circulation water when outdoor unit is operating under 10°C (50°F), and change the DIP switch on main PCB. (For more information on installation section.)

ARWN620LAS4 / ARWN640LAS4
ARWN680LAS4



HP			62	64	68
Model Name	Combination Unit		ARWN620LAS4	ARWN640LAS4	ARWN680LAS4
	Independent Unit		ARWN200LAS4 ARWN200LAS4 ARWN140LAS4 ARWN080LAS4	ARWN200LAS4 ARWN200LAS4 ARWN140LAS4 ARWN100LAS4	ARWN200LAS4 ARWN200LAS4 ARWN140LAS4 ARWN140LAS4
Capacity	Cooling (Rated)	kW	173.6	179.2	190.4
	Heating (Rated)	kW	195.3	201.6	214.2
Input	Cooling (Rated)	kW	34.10	35.33	38.08
	Heating (Rated)	kW	35.71	36.85	39.68
EER			5.09	5.07	5.00
COP	Rated Capacity		5.47	5.47	5.40
Exterior	Color		Warm Gray / Morning Gray	Warm Gray / Morning Gray	Warm Gray / Morning Gray
	RAL Code (Classic)		RAL 7044 / RAL 7030	RAL 7044 / RAL 7030	RAL 7044 / RAL 7030
Heat Exchanger	Type		Stainless Steel Plate	Stainless Steel Plate	Stainless Steel Plate
	Maximum Pressure Resistance	kgf/cm ²	45	45	45
	Head Loss	kPa	30.1 + 30.1 + 28.6 + 10.7	30.1 + 30.1 + 28.6 + 15.8	30.1 + 30.1 + 28.6 + 28.6
	Rated Water Flow	LPM	192 + 192 + 135 + 77	192 + 192 + 135 + 96	192 + 192 + 135 + 135
Compressor	Type		Hermetically Sealed Scroll	Hermetically Sealed Scroll	Hermetically Sealed Scroll
	Combination x No.		(Inverter) x 4	(Inverter) x 4	(Inverter) x 4
	Motor Output x Number	W x No.	5,300 x 2 + 4,200 x 2	5,300 x 2 + 4,200 x 2	5,300 x 2 + 4,200 x 2
	Oil Type		FVC68D (PVE)	FVC68D (PVE)	FVC68D (PVE)
	Oil Charge	cc	11,600	11,600	11,600
Refrigerant Connecting Pipes	Liquid Pipe	mm (inch)	Ø22.2 (7/8)	Ø22.2 (7/8)	Ø22.2 (7/8)
	Gas Pipe	mm (inch)	Ø44.5 (1-3/4)	Ø44.5 (1-3/4)	Ø53.98 (2-1/8)
Water Connecting Pipes	Inlet	A (inch)	40A (PT 1-1/2) + 40A (PT 1-1/2) + 40A (PT 1-1/2) + PT40 (Internal Thread)	40A (PT 1-1/2) + 40A (PT 1-1/2) + 40A (PT 1-1/2) + PT40 (Internal Thread)	40A (PT 1-1/2) + 40A (PT 1-1/2) + 40A (PT 1-1/2) + PT40 (Internal Thread)
	Outlet	A (inch)	40A (PT 1-1/2) + 40A (PT 1-1/2) + 40A (PT 1-1/2) + PT40 (Internal Thread)	40A (PT 1-1/2) + 40A (PT 1-1/2) + 40A (PT 1-1/2) + PT40 (Internal Thread)	40A (PT 1-1/2) + 40A (PT 1-1/2) + 40A (PT 1-1/2) + PT40 (Internal Thread)
	Drain Outlet	A (inch)	20A (PT 3/4) (External Thread)	20A (PT 3/4) (External Thread)	20A (PT 3/4) (External Thread)
Dimensions (W x H x D)	mm x No.		(755 x 997 x 500) x 4	(755 x 997 x 500) x 4	(755 x 997 x 500) x 4
Dimensions (W x H x D) - Shipping	mm x No.		(804 x 1,143 x 630) x 4	(804 x 1,143 x 630) x 4	(804 x 1,143 x 630) x 4
Net Weight	kg x No.		(140 x 2) + (127 x 2)	(140 x 2) + (127 x 2)	(140 x 2) + (127 x 2)
Shipping Weight	kg x No.		(150 x 2) + (137 x 2)	(150 x 2) + (137 x 2)	(150 x 2) + (137 x 2)
Sound Pressure Level	Cooling	dB(A)	61	61	61
	Heating	dB(A)	64	64	63
Sound Power Level	Cooling	dB(A)	73	73	75
	Heating	dB(A)	76	76	77
Communication Cable	mm ² x No. (VCTF-SB)		1.0 - 1.5 x 2C	1.0 - 1.5 x 2C	1.0 - 1.5 x 2C
Refrigerant	Refrigerant Name		R410A	R410A	R410A
	Precharged Amount in Factory	kg	17.6	17.6	17.6
	t-CO ₂ eq		36.740	36.740	36.740
	Control		Electronic Expansion Valve	Electronic Expansion Valve	Electronic Expansion Valve
Power Supply	Ø, V, Hz		3, 380-415, 50	3, 380-415, 50	3, 380-415, 50
Number of Maximum Connectable Indoor Units			64	64	64

- Note
- Maximum numbers are prepared based on assumption that all 2.2kW indoor units are connected. The numbers in parentheses means maximum connectable indoor units in accordance with outdoor units combination (160% - 200%). The recommended ratio is 130%.
 - Due to our policy of innovation some specifications may be changed without notification
 - Performances are based on the following conditions
 - Cooling : Indoor temp 27°C (80.6°F) DB / 19°C (66.2°F) WB, Water inlet temp 30°C (86°F)
 - Heating : Indoor temp 20°C (68°F) DB, Water inlet temp 20°C (68°F)
 - Interconnected Pipe Length is 7.5m and difference of Elevation (Outdoor - Indoor Unit) is 0m.
 - Sound pressure level is measured on the rated condition in the anechoic rooms by ISO 3745 standard. Sound power level is measured on the rated condition in the reverberation rooms by ISO 3741 standard. Therefore, these values can be increased owing to ambient conditions during operation.
 - This product contains Fluorinated Greenhouse Gases. (R410A, GWP (Global warming potential) = 2,087.5)
 - Add an anti freeze to circulation water when outdoor unit is operating under 10°C (50°F), and change the DIP switch on main PCB. (For more information on installation section.)

ARWN700LAS4 / ARWN740LAS4
ARWN800LAS4



HP		70	74	80
Model Name	Combination Unit	ARWN700LAS4	ARWN740LAS4	ARWN800LAS4
	Independent Unit	ARWN200LAS4 ARWN200LAS4 ARWN200LAS4 ARWN100LAS4	ARWN200LAS4 ARWN200LAS4 ARWN200LAS4 ARWN140LAS4	ARWN200LAS4 ARWN200LAS4 ARWN200LAS4 ARWN200LAS4
Capacity	Cooling (Rated) kW	196.0	207.2	224.0
	Heating (Rated) kW	220.5	233.1	252.0
Input	Cooling (Rated) kW	38.69	41.44	44.80
	Heating (Rated) kW	40.35	43.18	46.68
EER		5.07	5.00	5.00
COP	Rated Capacity	5.46	5.40	5.40
Exterior	Color	Warm Gray / Morning Gray	Warm Gray / Morning Gray	Warm Gray / Morning Gray
	RAL Code (Classic)	RAL 7044 / RAL 7030	RAL 7044 / RAL 7030	RAL 7044 / RAL 7030
Heat Exchanger	Type	Stainless Steel Plate	Stainless Steel Plate	Stainless Steel Plate
	Maximum Pressure Resistance kgf/cm ²	45	45	45
	Head Loss kPa	30.1 + 30.1 + 30.1 + 15.8	30.1 + 30.1 + 30.1 + 28.6	30.1 + 30.1 + 30.1 + 30.1
	Rated Water Flow LPM	192 + 192 + 192 + 96	192 + 192 + 192 + 135	192 + 192 + 192 + 192
Compressor	Type	Hermetically Sealed Scroll	Hermetically Sealed Scroll	Hermetically Sealed Scroll
	Combination x No.	(Inverter) x 4	(Inverter) x 4	(Inverter) x 4
	Motor Output x Number W x No.	5,300 x 3 + 4,200 x 1	5,300 x 3 + 4,200 x 1	5,300 x 4
	Oil Type	FVC68D (PVE)	FVC68D (PVE)	FVC68D (PVE)
	Oil Charge cc	11,800	11,800	12,000
Refrigerant Connecting Pipes	Liquid Pipe mm (inch)	Ø22.2 (7/8)	Ø22.2 (7/8)	Ø22.2 (7/8)
	Gas Pipe mm (inch)	Ø53.98 (2-1/8)	Ø53.98 (2-1/8)	Ø53.98 (2-1/8)
Water Connecting Pipes	Inlet A (inch)	40A (PT 1-1/2) + 40A (PT 1-1/2) + 40A (PT 1-1/2) + PT40 (Internal Thread)	40A (PT 1-1/2) + 40A (PT 1-1/2) + 40A (PT 1-1/2) + PT40 (Internal Thread)	40A (PT 1-1/2) + 40A (PT 1-1/2) + 40A (PT 1-1/2) + PT40 (Internal Thread)
	Outlet A (inch)	40A (PT 1-1/2) + 40A (PT 1-1/2) + 40A (PT 1-1/2) + PT40 (Internal Thread)	40A (PT 1-1/2) + 40A (PT 1-1/2) + 40A (PT 1-1/2) + PT40 (Internal Thread)	40A (PT 1-1/2) + 40A (PT 1-1/2) + 40A (PT 1-1/2) + PT40 (Internal Thread)
	Drain Outlet A (inch)	20A (PT 3/4) (External Thread)	20A (PT 3/4) (External Thread)	20A (PT 3/4) (External Thread)
Dimensions (W x H x D)	mm x No.	(755 x 997 x 500) x 4	(755 x 997 x 500) x 4	(755 x 997 x 500) x 4
Dimensions (W x H x D) - Shipping	mm x No.	(804 x 1,143 x 630) x 4	(804 x 1,143 x 630) x 4	(804 x 1,143 x 630) x 4
Net Weight	kg x No.	(140 x 3) + (127 x 1)	(140 x 3) + (127 x 1)	140 x 4
Shipping Weight	kg x No.	(150 x 3) + (137 x 1)	(150 x 3) + (137 x 1)	150 x 4
Sound Pressure Level	Cooling dB(A)	59	61	57
	Heating dB(A)	65	63	63
Sound Power Level	Cooling dB(A)	71	75	71
	Heating dB(A)	77	77	77
Communication Cable	mm ² x No. (VCTF-SB)	1.0 - 1.5 x 2C	1.0 - 1.5 x 2C	1.0 - 1.5 x 2C
Refrigerant	Refrigerant Name	R410A	R410A	R410A
	Precharged Amount in Factory kg	14.8	14.8	12.0
	t-CO ₂ eq	30.895	30.895	25.050
	Control	Electronic Expansion Valve	Electronic Expansion Valve	Electronic Expansion Valve
Power Supply	Ø, V, Hz	3, 380-415, 50	3, 380-415, 50	3, 380-415, 50
Number of Maximum Connectable Indoor Units ¹⁾		64	64	64

Note
 1. Maximum numbers are prepared based on assumption that all 2.2kW indoor units are connected. The numbers in parentheses means maximum connectable indoor units in accordance with outdoor units combination (160% - 200%). The recommended ratio is 130%.
 2. Due to our policy of innovation some specifications may be changed without notification.
 3. Performances are based on the following conditions
 - Cooling : Indoor temp 27°C (80.6°F) DB / 19°C (66.2°F) WB, Water inlet temp 30°C (86°F)
 - Heating : Indoor temp 20°C (68°F) DB, Water inlet temp 20°C (68°F)
 - Interconnected Pipe Length is 7.5m and difference of Elevation (Outdoor - Indoor Unit) is 0m.
 4. Sound pressure level is measured on the rated condition in the anechoic rooms by ISO 3745 standard. Sound power level is measured on the rated condition in the reverberation rooms by ISO 3741 standard. Therefore, these values can be increased owing to ambient conditions during operation.
 5. This product contains Fluorinated Greenhouse Gases. (R410A, GWP (Global warming potential) = 2,087.5)
 6. Add an anti freeze to circulation water when outdoor unit is operating under 10°C (50°F), and change the DIP switch on main PCB. (For more information on installation section.)

ARWB080LAS4 / ARWB100LAS4
ARWB140LAS4



HP		8	10	14
Model Name	Combination Unit	ARWB080LAS4	ARWB100LAS4	ARWB140LAS4
	Independent Unit	ARWB080LAS4	ARWB100LAS4	ARWB140LAS4
Capacity	Cooling (Rated) kW	22.4	28.0	39.2
	Heating (Rated) kW	25.2	31.5	44.1
Input	Cooling (Rated) kW	3.86	5.09	7.84
	Heating (Rated) kW	4.20	5.34	8.17
EER		5.80	5.50	5.00
COP	Rated Capacity	6.00	5.90	5.40
Exterior	Color	Warm Gray / Morning Gray	Warm Gray / Morning Gray	Warm Gray / Morning Gray
	RAL Code (Classic)	RAL 7044 / RAL 7030	RAL 7044 / RAL 7030	RAL 7044 / RAL 7030
Heat Exchanger	Type	Stainless Steel Plate	Stainless Steel Plate	Stainless Steel Plate
	Maximum Pressure Resistance kgf/cm ²	45	45	45
	Head Loss kPa	10.7	15.8	28.6
	Rated Water Flow LPM	77	96	135
Compressor	Type	Hermetically Sealed Scroll	Hermetically Sealed Scroll	Hermetically Sealed Scroll
	Combination x No.	(Inverter) x 1	(Inverter) x 1	(Inverter) x 1
	Motor Output x Number W x No.	4,200 x 1	4,200 x 1	4,200 x 1
	Oil Type	FVC68D (PVE)	FVC68D (PVE)	FVC68D (PVE)
	Oil Charge cc	2,800	2,800	2,800
Refrigerant Connecting Pipes	Liquid Pipe mm (inch)	Ø9.52 (3/8)	Ø9.52 (3/8)	Ø12.7 (1/2)
	Low Pressure Gas Pipe mm (inch)	Ø22.2 (7/8)	Ø22.2 (7/8)	Ø25.4 (1)
	High Pressure Gas Pipe mm (inch)	Ø19.05 (3/4)	Ø19.05 (3/4)	Ø19.05 (3/4)
Water Connecting Pipes	Inlet A (inch)	40A (PT 1-1/2) (Internal Thread)	40A (PT 1-1/2) (Internal Thread)	40A (PT 1-1/2) (Internal Thread)
	Outlet A (inch)	40A (PT 1-1/2) (Internal Thread)	40A (PT 1-1/2) (Internal Thread)	40A (PT 1-1/2) (Internal Thread)
	Drain Outlet A (inch)	20A (PT 3/4) (External Thread)	20A (PT 3/4) (External Thread)	20A (PT 3/4) (External Thread)
Dimensions (W x H x D)	mm x No.	(755 x 997 x 500) x 1	(755 x 997 x 500) x 1	(755 x 997 x 500) x 1
Dimensions (W x H x D) - Shipping	mm x No.	(804 x 1,143 x 630) x 1	(804 x 1,143 x 630) x 1	(804 x 1,143 x 630) x 1
Net Weight	kg x No.	127 x 1	127 x 1	127 x 1
Shipping Weight	kg x No.	137 x 1	137 x 1	137 x 1
Sound Pressure Level	Cooling dB(A)	47	50	58
	Heating dB(A)	51	53	57
Sound Power Level	Cooling dB(A)	59	62	70
	Heating dB(A)	63	65	69
Communication Cable	mm ² x No. (VCTF-SB)	1.0 - 1.5 x 2C	1.0 - 1.5 x 2C	1.0 - 1.5 x 2C
Refrigerant	Refrigerant Name	R410A	R410A	R410A
	Precharged Amount in Factory kg	5.8	5.8	5.8
	t-CO ₂ eq	12.108	12.108	12.108
	Control	Electronic Expansion Valve	Electronic Expansion Valve	Electronic Expansion Valve
Power Supply	Ø, V, Hz	3, 380-415, 50	3, 380-415, 50	3, 380-415, 50
Number of Maximum Connectable Indoor Units ¹⁾		13 (20)	16 (25)	23 (35)

Note
 1. Maximum numbers are prepared based on assumption that all 2.2kW indoor units are connected. The numbers in parentheses means maximum connectable indoor units in accordance with outdoor units combination (160% - 200%). The recommended ratio is 130%.
 2. Due to our policy of innovation some specifications may be changed without notification.
 3. Performances are based on the following conditions
 - Cooling : Indoor temp 27°C (80.6°F) DB / 19°C (66.2°F) WB, Water inlet temp 30°C (86°F)
 - Heating : Indoor temp 20°C (68°F) DB, Water inlet temp 20°C (68°F)
 - Interconnected Pipe Length is 7.5m and difference of Elevation (Outdoor - Indoor Unit) is 0m.
 4. Sound pressure level is measured on the rated condition in the anechoic rooms by ISO 3745 standard. Sound power level is measured on the rated condition in the reverberation rooms by ISO 3741 standard. Therefore, these values can be increased owing to ambient conditions during operation.
 5. This product contains Fluorinated Greenhouse Gases. (R410A, GWP (Global warming potential) = 2,087.5)
 6. Add an anti freeze to circulation water when outdoor unit is operating under 10°C (50°F), and change the DIP switch on main PCB. (For more information on installation section.)

ARWB200LAS4 / ARWB160LAS4
ARWB180LAS4



HP		20	16	18	
Model Name	Combination Unit	ARWB200LAS4	ARWB160LAS4	ARWB180LAS4	
	Independent Unit	ARWB200LAS4	ARWB080LAS4 ARWB080LAS4	ARWB100LAS4 ARWB080LAS4	
Capacity	Cooling (Rated) kW	56.0	44.8	50.4	
	Heating (Rated) kW	63.0	50.4	56.7	
Input	Cooling (Rated) kW	11.20	7.72	8.95	
	Heating (Rated) kW	11.67	8.40	9.54	
EER		5.00	5.80	5.63	
COP	Rated Capacity	5.40	6.00	5.94	
Exterior	Color	Warm Gray / Morning Gray	Warm Gray / Morning Gray	Warm Gray / Morning Gray	
	RAL Code (Classic)	RAL 7044 / RAL 7030	RAL 7044 / RAL 7030	RAL 7044 / RAL 7030	
Heat Exchanger	Type	Stainless Steel Plate	Stainless Steel Plate	Stainless Steel Plate	
	Maximum Pressure Resistance	kgf/cm ²	45	45	
	Head Loss	kPa	30.1	10.7 + 10.7	15.8 + 10.7
	Rated Water Flow	LPM	192	77 + 77	96 + 77
Compressor	Type	Hermetically Sealed Scroll	Hermetically Sealed Scroll	Hermetically Sealed Scroll	
	Combination x No.	(Inverter) x 1	(Inverter) x 2	(Inverter) x 2	
	Motor Output x Number	W x No.	5,300 x 1	4,200 x 2	4,200 x 2
	Oil Type	FVC68D(PVE)	FVC68D(PVE)	FVC68D(PVE)	
	Oil Charge	cc	3,000	5,600	5,600
Refrigerant Connecting Pipes	Liquid Pipe	mm (inch)	Ø12.7 (1/2)	Ø12.7 (1/2)	Ø12.7 (1/2)
	Low Pressure Gas Pipe	mm (inch)	Ø28.58 (1-1/8)	Ø28.58 (1-1/8)	Ø28.58 (1-1/8)
	High Pressure Gas Pipe	mm (inch)	Ø19.05 (3/4)	Ø19.05 (3/4)	Ø19.05 (3/4)
Water Connecting Pipes	Inlet	A (inch)	40A (PT 1-1/2) (Internal Thread)	40A (PT 1-1/2) + 40A (PT 1-1/2) (Internal Thread)	40A (PT 1-1/2) + 40A (PT 1-1/2) (Internal Thread)
	Outlet	A (inch)	40A (PT 1-1/2) (Internal Thread)	40A (PT 1-1/2) + 40A (PT 1-1/2) (Internal Thread)	40A (PT 1-1/2) + 40A (PT 1-1/2) (Internal Thread)
	Drain Outlet	A (inch)	20A (PT 3/4) (External Thread)	20A (PT 3/4) (External Thread)	20A (PT 3/4) (External Thread)
Dimensions (W x H x D)	mm x No.	(755 x 997 x 500) x 1	(755 x 997 x 500) x 2	(755 x 997 x 500) x 2	
Dimensions (W x H x D) - Shipping	mm x No.	(804 x 1,143 x 630) x 1	(804 x 1,143 x 630) x 2	(804 x 1,143 x 630) x 2	
Net Weight	kg x No.	140 x 1	127 x 2	127 x 2	
Shipping Weight	kg x No.	150 x 1	137 x 2	137 x 2	
Sound Pressure Level	Cooling	dB(A)	54	50	52
	Heating	dB(A)	60	54	55
Sound Power Level	Cooling	dB(A)	66	62	64
	Heating	dB(A)	72	66	67
Communication Cable	mm ² x No. (VCTF-SB)	1.0 - 1.5 x 2C	1.0 - 1.5 x 2C	1.0 - 1.5 x 2C	
Refrigerant	Refrigerant Name		R410A	R410A	R410A
	Precharged Amount in Factory	kg	3.0	11.6	11.6
	t-CO ₂ eq		6.263	24.215	24.215
	Control		Electronic Expansion Valve	Electronic Expansion Valve	Electronic Expansion Valve
Power Supply	Ø, V, Hz	3, 380-415, 50	3, 380-415, 50	3, 380-415, 50	
Number of Maximum Connectable Indoor Units		32(50)	26(40)	29(45)	

- Note
- Maximum numbers are prepared based on assumption that all 2.2kW indoor units are connected. The numbers in parentheses means maximum connectable indoor units in accordance with outdoor units combination (160% - 200%). The recommended ratio is 130%.
 - Due to our policy of innovation some specifications may be changed without notification
 - Performances are based on the following conditions
 - Cooling : Indoor temp 27°C (80.6°F) DB / 19°C (66.2°F) WB, Water inlet temp 30°C (86°F)
 - Heating : Indoor temp 20°C (68°F) DB, Water inlet temp 20°C (68°F)
 - Interconnected Pipe Length is 7.5m and difference of Elevation (Outdoor - Indoor Unit) is 0m.
 - Sound pressure level is measured on the rated condition in the anechoic rooms by ISO 3745 standard. Sound power level is measured on the rated condition in the reverberation rooms by ISO 3741 standard. Therefore, these values can be increased owing to ambient conditions during operation.
 - This product contains Fluorinated Greenhouse Gases. (R410A, GWP (Global warming potential) = 2,087.5)
 - Add an anti freeze to circulation water when outdoor unit is operating under 10°C (50°F), and change the DIP switch on main PCB. (For more information on installation section.)

ARWB220LAS4 / ARWB240LAS4
ARWB280LAS4



HP		22	24	28	
Model Name	Combination Unit	ARWB220LAS4	ARWB240LAS4	ARWB280LAS4	
	Independent Unit	ARWB140LAS4 ARWB080LAS4	ARWB140LAS4 ARWB100LAS4	ARWB140LAS4 ARWB140LAS4	
Capacity	Cooling (Rated) kW	61.6	67.2	78.4	
	Heating (Rated) kW	69.3	75.6	88.2	
Input	Cooling (Rated) kW	11.70	12.93	15.68	
	Heating (Rated) kW	12.37	13.51	16.34	
EER		5.26	5.20	5.00	
COP	Rated Capacity	5.60	5.60	5.40	
Exterior	Color	Warm Gray / Morning Gray	Warm Gray / Morning Gray	Warm Gray / Morning Gray	
	RAL Code (Classic)	RAL 7044 / RAL 7030	RAL 7044 / RAL 7030	RAL 7044 / RAL 7030	
Heat Exchanger	Type	Stainless Steel Plate	Stainless Steel Plate	Stainless Steel Plate	
	Maximum Pressure Resistance	kgf/cm ²	45	45	
	Head Loss	kPa	28.6 + 10.7	28.6 + 15.8	28.6 + 28.6
	Rated Water Flow	LPM	135 + 77	135 + 96	135 + 135
Compressor	Type	Hermetically Sealed Scroll	Hermetically Sealed Scroll	Hermetically Sealed Scroll	
	Combination x No.	(Inverter) x 2	(Inverter) x 2	(Inverter) x 2	
	Motor Output x Number	W x No.	4,200 x 2	4,200 x 2	4,200 x 2
	Oil Type	FVC68D (PVE)	FVC68D (PVE)	FVC68D (PVE)	
	Oil Charge	cc	5,600	5,600	5,600
Refrigerant Connecting Pipes	Liquid Pipe	mm (inch)	Ø19.05 (3/4)	Ø19.05 (3/4)	Ø19.05 (3/4)
	Low Pressure Gas Pipe	mm (inch)	Ø34.9 (1-3/8)	Ø34.9 (1-3/8)	Ø34.9 (1-3/8)
	High Pressure Gas Pipe	mm (inch)	Ø28.58 (1-1/8)	Ø28.58 (1-1/8)	Ø28.58 (1-1/8)
Water Connecting Pipes	Inlet	A (inch)	40A (PT 1-1/2) + 40A (PT 1-1/2) (Internal Thread)	40A (PT 1-1/2) + 40A (PT 1-1/2) (Internal Thread)	40A (PT 1-1/2) + 40A (PT 1-1/2) (Internal Thread)
	Outlet	A (inch)	40A (PT 1-1/2) + 40A (PT 1-1/2) (Internal Thread)	40A (PT 1-1/2) + 40A (PT 1-1/2) (Internal Thread)	40A (PT 1-1/2) + 40A (PT 1-1/2) (Internal Thread)
	Drain Outlet	A (inch)	20A (PT 3/4) (External Thread)	20A (PT 3/4) (External Thread)	20A (PT 3/4) (External Thread)
Dimensions (W x H x D)	mm x No.	(755 x 997 x 500) x 2	(755 x 997 x 500) x 2	(755 x 997 x 500) x 2	
Dimensions (W x H x D) - Shipping	mm x No.	(804 x 1,143 x 630) x 2	(804 x 1,143 x 630) x 2	(804 x 1,143 x 630) x 2	
Net Weight	kg x No.	127 x 2	127 x 2	127 x 2	
Shipping Weight	kg x No.	137 x 2	137 x 2	137 x 2	
Sound Pressure Level	Cooling	dB(A)	58	59	59
	Heating	dB(A)	58	58	58
Sound Power Level	Cooling	dB(A)	70	71	72
	Heating	dB(A)	70	70	71
Communication Cable	mm ² x No. (VCTF-SB)	1.0 - 1.5 x 2C	1.0 - 1.5 x 2C	1.0 - 1.5 x 2C	
Refrigerant	Refrigerant Name		R410A	R410A	R410A
	Precharged Amount in Factory	kg	11.6	11.6	11.6
	t-CO ₂ eq		24.215	24.215	24.215
	Control		Electronic Expansion Valve	Electronic Expansion Valve	Electronic Expansion Valve
Power Supply	Ø, V, Hz	3, 380-415, 50	3, 380-415, 50	3, 380-415, 50	
Number of Maximum Connectable Indoor Units		35 (44)	39 (48)	45 (56)	

- Note
- Maximum numbers are prepared based on assumption that all 2.2kW indoor units are connected. The numbers in parentheses means maximum connectable indoor units in accordance with outdoor units combination (160% - 200%). The recommended ratio is 130%.
 - Due to our policy of innovation some specifications may be changed without notification
 - Performances are based on the following conditions
 - Cooling : Indoor temp 27°C (80.6°F) DB / 19°C (66.2°F) WB, Water inlet temp 30°C (86°F)
 - Heating : Indoor temp 20°C (68°F) DB, Water inlet temp 20°C (68°F)
 - Interconnected Pipe Length is 7.5m and difference of Elevation (Outdoor - Indoor Unit) is 0m.
 - Sound pressure level is measured on the rated condition in the anechoic rooms by ISO 3745 standard. Sound power level is measured on the rated condition in the reverberation rooms by ISO 3741 standard. Therefore, these values can be increased owing to ambient conditions during operation.
 - This product contains Fluorinated Greenhouse Gases. (R410A, GWP (Global warming potential) = 2,087.5)
 - Add an anti freeze to circulation water when outdoor unit is operating under 10°C (50°F), and change the DIP switch on main PCB. (For more information on installation section.)

**ARWB300LAS4 / ARWB340LAS4
ARWB400LAS4**



HP		30	34	40	
Model Name	Combination Unit	ARWB300LAS4	ARWB340LAS4	ARWB400LAS4	
	Independent Unit	ARWB200LAS4 ARWB100LAS4	ARWB200LAS4 ARWB140LAS4	ARWB200LAS4 ARWB140LAS4	
Capacity	Cooling (Rated) kW	84.0	95.2	112.0	
	Heating (Rated) kW	94.5	107.1	126.0	
Input	Cooling (Rated) kW	16.29	19.04	22.40	
	Heating (Rated) kW	17.01	19.84	23.34	
EER		5.16	5.00	5.00	
COP	Rated Capacity	5.56	5.40	5.40	
Exterior	Color	Warm Gray / Morning Gray	Warm Gray / Morning Gray	Warm Gray / Morning Gray	
	RAL Code (Classic)	RAL 7044 / RAL 7030	RAL 7044 / RAL 7030	RAL 7044 / RAL 7030	
Heat Exchanger	Type	Stainless Steel Plate	Stainless Steel Plate	Stainless Steel Plate	
	Maximum Pressure Resistance	kgf/cm ²	45	45	
	Head Loss	kPa	30.1 + 15.8	30.1 + 28.6	30.1 + 30.1
	Rated Water Flow	LPM	192 + 96	192 + 135	192 + 192
Compressor	Type	Hermetically Sealed Scroll	Hermetically Sealed Scroll	Hermetically Sealed Scroll	
	Combination x No.	(Inverter) x 2	(Inverter) x 2	(Inverter) x 2	
	Motor Output x Number	W x No.	5,300 x 1 + 4,200 x 1	5,300 x 1 + 4,200 x 1	5,300 x 2
	Oil Type	FVC68D (PVE)	FVC68D (PVE)	FVC68D (PVE)	
	Oil Charge	cc	5,800	5,800	6,000
Refrigerant Connecting Pipes	Liquid Pipe	mm (inch)	Ø19.05 (3/4)	Ø19.05 (3/4)	Ø19.05 (3/4)
	Low Pressure Gas Pipe	mm (inch)	Ø34.9 (1-3/8)	Ø34.9 (1-3/8)	Ø41.3 (1-5/8)
	High Pressure Gas Pipe	mm (inch)	Ø28.58 (1-1/8)	Ø28.58 (1-1/8)	Ø34.9 (1-3/8)
Water Connecting Pipes	Inlet	A (inch)	40A (PT 1-1/2) + 40A (PT 1-1/2) (Internal Thread)	40A (PT 1-1/2) + 40A (PT 1-1/2) (Internal Thread)	40A (PT 1-1/2) + 40A (PT 1-1/2) (Internal Thread)
	Outlet	A (inch)	40A (PT 1-1/2) + 40A (PT 1-1/2) (Internal Thread)	40A (PT 1-1/2) + 40A (PT 1-1/2) (Internal Thread)	40A (PT 1-1/2) + 40A (PT 1-1/2) (Internal Thread)
	Drain Outlet	A (inch)	20A (PT 3/4) (External Thread)	20A (PT 3/4) (External Thread)	20A (PT 3/4) (External Thread)
Dimensions (W x H x D)	mm x No.	(755 x 997 x 500) x 2	(755 x 997 x 500) x 2	(755 x 997 x 500) x 2	
Dimensions (W x H x D) - Shipping	mm x No.	(804 x 1,143 x 630) x 2	(804 x 1,143 x 630) x 2	(804 x 1,143 x 630) x 2	
Net Weight	kg x No.	(140 x 1) + (127 x 1)	(140 x 1) + (127 x 1)	140 x 2	
Shipping Weight	kg x No.	(150 x 1) + (137 x 1)	(150 x 1) + (137 x 1)	150 x 2	
Sound Pressure Level	Cooling	dB(A)	55	59	55
	Heating	dB(A)	61	61	61
Sound Power Level	Cooling	dB(A)	67	72	68
	Heating	dB(A)	73	74	74
Communication Cable	mm ² x No. (VCTF-SB)	1.0 - 1.5 x 2C	1.0 - 1.5 x 2C	1.0 - 1.5 x 2C	
Refrigerant	Refrigerant Name		R410A	R410A	R410A
	Precharged Amount in Factory	kg	8.8	8.8	6.0
	t-CO ₂ eq		18.370	18.370	12.525
	Control		Electronic Expansion Valve	Electronic Expansion Valve	Electronic Expansion Valve
Power Supply	Ø, V, Hz	3, 380-415, 50	3, 380-415, 50	3, 380-415, 50	
Number of Maximum Connectable Indoor Units		49 (60)	55 (64)	64	

Note
 1. Maximum numbers are prepared based on assumption that all 2.2kW indoor units are connected. The numbers in parentheses means maximum connectable indoor units in accordance with outdoor units combination (160% - 200%). The recommended ratio is 130%.
 2. Due to our policy of innovation some specifications may be changed without notification.
 3. Performances are based on the following conditions
 - Cooling : Indoor temp 27°C (80.6°F) DB / 19°C (66.2°F) WB, Water inlet temp 30°C (86°F)
 - Heating : Indoor temp 20°C (68°F) DB, Water inlet temp 20°C (68°F)
 - Interconnected Pipe Length is 7.5m and difference of Elevation (Outdoor - Indoor Unit) is 0m.
 4. Sound pressure level is measured on the rated condition in the anechoic rooms by ISO 3745 standard. Sound power level is measured on the rated condition in the reverberation rooms by ISO 3741 standard. Therefore, these values can be increased owing to ambient conditions during operation.
 5. This product contains Fluorinated Greenhouse Gases. (R410A, GWP (Global warming potential) = 2,087.5)
 6. Add an anti freeze to circulation water when outdoor unit is operating under 10°C (50°F), and change the DIP switch on main PCB. (For more information on installation section.)

**ARWB420LAS4 / ARWB440LAS4
ARWB480LAS4**



HP		42	44	48	
Model Name	Combination Unit	ARWB420LAS4	ARWB440LAS4	ARWB480LAS4	
	Independent Unit	ARWB200LAS4 ARWB140LAS4 ARWB080LAS4	ARWB200LAS4 ARWB140LAS4 ARWB100LAS4	ARWB200LAS4 ARWB140LAS4 ARWB140LAS4	
Capacity	Cooling (Rated) kW	117.6	123.2	134.4	
	Heating (Rated) kW	132.3	138.6	151.2	
Input	Cooling (Rated) kW	22.9	24.13	26.88	
	Heating (Rated) kW	24.04	25.18	28.01	
EER		5.14	5.11	5.00	
COP	Rated Capacity	5.50	5.50	5.40	
Exterior	Color	Warm Gray / Morning Gray	Warm Gray / Morning Gray	Warm Gray / Morning Gray	
	RAL Code (Classic)	RAL 7044 / RAL 7030	RAL 7044 / RAL 7030	RAL 7044 / RAL 7030	
Heat Exchanger	Type	Stainless Steel Plate	Stainless Steel Plate	Stainless Steel Plate	
	Maximum Pressure Resistance	kgf/cm ²	45	45	
	Head Loss	kPa	30.1 + 28.6 + 10.7	30.1 + 28.6 + 15.8	30.1 + 28.6 + 28.6
	Rated Water Flow	LPM	192 + 135 + 77	192 + 135 + 96	192 + 135 + 135
Compressor	Type	Hermetically Sealed Scroll	Hermetically Sealed Scroll	Hermetically Sealed Scroll	
	Combination x No.	(Inverter) x 3	(Inverter) x 3	(Inverter) x 3	
	Motor Output x Number	W x No.	5,300 x 1 + 4,200 x 2	5,300 x 1 + 4,200 x 2	5,300 x 1 + 4,200 x 2
	Oil Type	FVC68D (PVE)	FVC68D (PVE)	FVC68D (PVE)	
	Oil Charge	cc	8,600	8,600	8,600
Refrigerant Connecting Pipes	Liquid Pipe	mm (inch)	Ø19.05 (3/4)	Ø19.05 (3/4)	Ø19.05 (3/4)
	Low Pressure Gas Pipe	mm (inch)	Ø41.3 (1-5/8)	Ø41.3 (1-5/8)	Ø41.3 (1-5/8)
	High Pressure Gas Pipe	mm (inch)	Ø34.9 (1-3/8)	Ø34.9 (1-3/8)	Ø34.9 (1-3/8)
Water Connecting Pipes	Inlet	A (inch)	40A (PT 1-1/2) + 40A (PT 1-1/2) + 40A (PT 1-1/2) (Internal Thread)	40A (PT 1-1/2) + 40A (PT 1-1/2) + 40A (PT 1-1/2) (Internal Thread)	40A (PT 1-1/2) + 40A (PT 1-1/2) + 40A (PT 1-1/2) (Internal Thread)
	Outlet	A (inch)	40A (PT 1-1/2) + 40A (PT 1-1/2) + 40A (PT 1-1/2) (Internal Thread)	40A (PT 1-1/2) + 40A (PT 1-1/2) + 40A (PT 1-1/2) (Internal Thread)	40A (PT 1-1/2) + 40A (PT 1-1/2) + 40A (PT 1-1/2) (Internal Thread)
	Drain Outlet	A (inch)	20A (PT 3/4) (External Thread)	20A (PT 3/4) (External Thread)	20A (PT 3/4) (External Thread)
Dimensions (W x H x D)	mm x No.	(755 x 997 x 500) x 3	(755 x 997 x 500) x 3	(755 x 997 x 500) x 3	
Dimensions (W x H x D) - Shipping	mm x No.	(804 x 1,143 x 630) x 3	(804 x 1,143 x 630) x 3	(804 x 1,143 x 630) x 3	
Net Weight	kg x No.	(140 x 1) + (127 x 2)	(140 x 1) + (127 x 2)	(140 x 1) + (127 x 2)	
Shipping Weight	kg x No.	(150 x 1) + (137 x 2)	(150 x 1) + (137 x 2)	(150 x 1) + (137 x 2)	
Sound Pressure Level	Cooling	dB(A)	60	60	60
	Heating	dB(A)	62	62	62
Sound Power Level	Cooling	dB(A)	72	72	74
	Heating	dB(A)	74	74	76
Communication Cable	mm ² x No. (VCTF-SB)	1.0 - 1.5 x 2C	1.0 - 1.5 x 2C	1.0 - 1.5 x 2C	
Refrigerant	Refrigerant Name		R410A	R410A	R410A
	Precharged Amount in Factory	kg	14.6	14.6	14.6
	t-CO ₂ eq		30.478	30.478	30.478
	Control		Electronic Expansion Valve	Electronic Expansion Valve	Electronic Expansion Valve
Power Supply	Ø, V, Hz	3, 380-415, 50	3, 380-415, 50	3, 380-415, 50	
Number of Maximum Connectable Indoor Units		64	64	64	

Note
 1. Maximum numbers are prepared based on assumption that all 2.2kW indoor units are connected. The numbers in parentheses means maximum connectable indoor units in accordance with outdoor units combination (160% - 200%). The recommended ratio is 130%.
 2. Due to our policy of innovation some specifications may be changed without notification.
 3. Performances are based on the following conditions
 - Cooling : Indoor temp 27°C (80.6°F) DB / 19°C (66.2°F) WB, Water inlet temp 30°C (86°F)
 - Heating : Indoor temp 20°C (68°F) DB, Water inlet temp 20°C (68°F)
 - Interconnected Pipe Length is 7.5m and difference of Elevation (Outdoor - Indoor Unit) is 0m.
 4. Sound pressure level is measured on the rated condition in the anechoic rooms by ISO 3745 standard. Sound power level is measured on the rated condition in the reverberation rooms by ISO 3741 standard. Therefore, these values can be increased owing to ambient conditions during operation.
 5. This product contains Fluorinated Greenhouse Gases. (R410A, GWP (Global warming potential) = 2,087.5)
 6. Add an anti freeze to circulation water when outdoor unit is operating under 10°C (50°F), and change the DIP switch on main PCB. (For more information on installation section.)

ARWB500LAS4 / ARWB540LAS4
ARWB600LAS4



HP			50	54	60
Model Name	Combination Unit		ARWB500LAS4	ARWB540LAS4	ARWB600LAS4
	Independent Unit		ARWB200LAS4 ARWB200LAS4 ARWB100LAS4	ARWB200LAS4 ARWB200LAS4 ARWB140LAS4	ARWB200LAS4 ARWB200LAS4 ARWB200LAS4
Capacity	Cooling (Rated)	kW	140.0	151.2	168.0
	Heating (Rated)	kW	157.5	170.1	189.0
Input	Cooling (Rated)	kW	27.49	30.24	33.60
	Heating (Rated)	kW	28.68	31.51	35.01
EER			5.09	5.00	5.00
COP	Rated Capacity		5.49	5.40	5.40
Exterior	Color		Warm Gray / Morning Gray	Warm Gray / Morning Gray	Warm Gray / Morning Gray
	RAL Code (Classic)		RAL 7044 / RAL 7030	RAL 7044 / RAL 7030	RAL 7044 / RAL 7030
Heat Exchanger	Type		Stainless Steel Plate	Stainless Steel Plate	Stainless Steel Plate
	Maximum Pressure Resistance	kgf/cm ²	45	45	45
	Head Loss	kPa	30.1 + 30.1 + 15.8	30.1 + 28.6 + 28.6	30.1 + 30.1 + 30.1
	Rated Water Flow	LPM	192 + 192 + 96	192 + 192 + 135	192 + 192 + 192
Compressor	Type		Hermetically Sealed Scroll	Hermetically Sealed Scroll	Hermetically Sealed Scroll
	Combination x No.		(Inverter) x 3	(Inverter) x 3	(Inverter) x 3
	Motor Output x Number	W x No.	5,300 x 2 + 4,200 x 1	5,300 x 2 + 4,200 x 1	5,300 x 3
	Oil Type		FVC68D (PVE)	FVC68D (PVE)	FVC68D (PVE)
	Oil Charge	cc	8,800	8,800	9,000
Refrigerant Connecting Pipes	Liquid Pipe	mm (inch)	Ø19.05 (3/4)	Ø19.05 (3/4)	Ø19.05 (3/4)
	Low Pressure Gas Pipe	mm (inch)	Ø41.3 (1-5/8)	Ø41.3 (1-5/8)	Ø41.3 (1-5/8)
	High Pressure Gas Pipe	mm (inch)	Ø34.9 (1-3/8)	Ø34.9 (1-3/8)	Ø34.9 (1-3/8)
Water Connecting Pipes	Inlet	A (inch)	40A (PT 1-1/2) + 40A (PT 1-1/2) + 40A (PT 1-1/2) (Internal Thread)	40A (PT 1-1/2) + 40A (PT 1-1/2) + 40A (PT 1-1/2) (Internal Thread)	40A (PT 1-1/2) + 40A (PT 1-1/2) + 40A (PT 1-1/2) (Internal Thread)
	Outlet	A (inch)	40A (PT 1-1/2) + 40A (PT 1-1/2) + 40A (PT 1-1/2) (Internal Thread)	40A (PT 1-1/2) + 40A (PT 1-1/2) + 40A (PT 1-1/2) (Internal Thread)	40A (PT 1-1/2) + 40A (PT 1-1/2) + 40A (PT 1-1/2) (Internal Thread)
	Drain Outlet	A (inch)	20A (PT 3/4) (External Thread)	20A (PT 3/4) (External Thread)	20A (PT 3/4) (External Thread)
Dimensions (W x H x D)	mm x No.		(755 x 997 x 500) x 3	(755 x 997 x 500) x 3	(755 x 997 x 500) x 3
Dimensions (W x H x D) - Shipping	mm x No.		(804 x 1,143 x 630) x 3	(804 x 1,143 x 630) x 3	(804 x 1,143 x 630) x 3
Net Weight	kg x No.		(140 x 2) + (127 x 1)	(140 x 2) + (127 x 1)	140 x 3
Shipping Weight	kg x No.		(150 x 2) + (137 x 1)	(150 x 2) + (137 x 1)	150 x 3
Sound Pressure Level	Cooling	dB(A)	58	60	56
	Heating	dB(A)	63	62	62
Sound Power Level	Cooling	dB(A)	70	74	70
	Heating	dB(A)	75	76	76
Communication Cable	mm ² x No. (VCTF-SB)		1.0 - 1.5 x 2C	1.0 - 1.5 x 2C	1.0 - 1.5 x 2C
Refrigerant	Refrigerant Name		R410A	R410A	R410A
	Precharged Amount in Factory		11.8	11.8	9.0
	t-CO ₂ eq		24.633	24.633	18.788
Control			Electronic Expansion Valve	Electronic Expansion Valve	Electronic Expansion Valve
Power Supply	Ø, V, Hz		3, 380-415, 50	3, 380-415, 50	3, 380-415, 50
Number of Maximum Connectable Indoor Units			64	64	64

- Note
- Maximum numbers are prepared based on assumption that all 2.2kW indoor units are connected. The numbers in parentheses means maximum connectable indoor units in accordance with outdoor units combination (160% - 200%). The recommended ratio is 130%.
 - Due to our policy of innovation some specifications may be changed without notification
 - Performances are based on the following conditions
 - Cooling : Indoor temp 27°C (80.6°F) DB / 19°C (66.2°F) WB, Water inlet temp 30°C (86°F)
 - Heating : Indoor temp 20°C (68°F) DB, Water inlet temp 20°C (68°F)
 - Interconnected Pipe Length is 7.5m and difference of Elevation (Outdoor - Indoor Unit) is 0m.
 - Sound pressure level is measured on the rated condition in the anechoic rooms by ISO 3745 standard. Sound power level is measured on the rated condition in the reverberation rooms by ISO 3741 standard. Therefore, these values can be increased owing to ambient conditions during operation.
 - This product contains Fluorinated Greenhouse Gases. (R410A, GWP (Global warming potential) = 2,087.5)
 - Add an anti freeze to circulation water when outdoor unit is operating under 10°C (50°F), and change the DIP switch on main PCB. (For more information on installation section.)

ARWB620LAS4 / ARWB640LAS4
ARWB680LAS4



HP			62	64	68
Model Name	Combination Unit		ARWB620LAS4	ARWB640LAS4	ARWB680LAS4
	Independent Unit		ARWB200LAS4 ARWB200LAS4 ARWB140LAS4 ARWB080LAS4	ARWB200LAS4 ARWB200LAS4 ARWB140LAS4 ARWB100LAS4	ARWB200LAS4 ARWB200LAS4 ARWB140LAS4 ARWB140LAS4
Capacity	Cooling (Rated)	kW	173.6	179.2	190.4
	Heating (Rated)	kW	195.3	201.6	214.2
Input	Cooling (Rated)	kW	34.10	35.33	38.08
	Heating (Rated)	kW	35.71	36.85	39.68
EER			5.09	5.07	5.00
COP	Rated Capacity		5.47	5.47	5.40
Exterior	Color		Warm Gray / Morning Gray	Warm Gray / Morning Gray	Warm Gray / Morning Gray
	RAL Code (Classic)		RAL 7044 / RAL 7030	RAL 7044 / RAL 7030	RAL 7044 / RAL 7030
Heat Exchanger	Type		Stainless Steel Plate	Stainless Steel Plate	Stainless Steel Plate
	Maximum Pressure Resistance	kgf/cm ²	45	45	45
	Head Loss	kPa	30.1 + 30.1 + 28.6 + 10.7	30.1 + 30.1 + 28.6 + 15.8	30.1 + 30.1 + 28.6 + 28.6
	Rated Water Flow	LPM	192 + 192 + 135 + 77	192 + 192 + 135 + 96	192 + 192 + 135 + 135
Compressor	Type		Hermetically Sealed Scroll	Hermetically Sealed Scroll	Hermetically Sealed Scroll
	Combination x No.		(Inverter) x 4	(Inverter) x 4	(Inverter) x 4
	Motor Output x Number	W x No.	5,300 x 2 + 4,200 x 2	5,300 x 2 + 4,200 x 2	5,300 x 2 + 4,200 x 2
	Oil Type		FVC68D (PVE)	FVC68D (PVE)	FVC68D (PVE)
	Oil Charge	cc	11,600	11,600	11,600
Refrigerant Connecting Pipes	Liquid Pipe	mm (inch)	Ø22.2 (7/8)	Ø22.2 (7/8)	Ø22.2 (7/8)
	Low Pressure Gas Pipe	mm (inch)	Ø44.5 (1-3/4)	Ø44.5 (1-3/4)	Ø53.98 (2-1/8)
	High Pressure Gas Pipe	mm (inch)	Ø41.3 (1-5/8)	Ø41.3 (1-5/8)	Ø44.5 (1-3/4)
Water Connecting Pipes	Inlet	A (inch)	40A (PT 1-1/2) + 40A (PT 1-1/2) + 40A (PT 1-1/2) + PT40 (Internal Thread)	40A (PT 1-1/2) + 40A (PT 1-1/2) + 40A (PT 1-1/2) + PT40 (Internal Thread)	40A (PT 1-1/2) + 40A (PT 1-1/2) + 40A (PT 1-1/2) + PT40 (Internal Thread)
	Outlet	A (inch)	40A (PT 1-1/2) + 40A (PT 1-1/2) + 40A (PT 1-1/2) + PT40 (Internal Thread)	40A (PT 1-1/2) + 40A (PT 1-1/2) + 40A (PT 1-1/2) + PT40 (Internal Thread)	40A (PT 1-1/2) + 40A (PT 1-1/2) + 40A (PT 1-1/2) + PT40 (Internal Thread)
	Drain Outlet	A (inch)	20A (PT 3/4) (External Thread)	20A (PT 3/4) (External Thread)	20A (PT 3/4) (External Thread)
Dimensions (W x H x D)	mm x No.		(755 x 997 x 500) x 4	(755 x 997 x 500) x 4	(755 x 997 x 500) x 4
Dimensions (W x H x D) - Shipping	mm x No.		(804 x 1,143 x 630) x 4	(804 x 1,143 x 630) x 4	(804 x 1,143 x 630) x 4
Net Weight	kg x No.		(140 x 2) + (127 x 2)	(140 x 2) + (127 x 2)	(140 x 2) + (127 x 2)
Shipping Weight	kg x No.		(150 x 2) + (137 x 2)	(150 x 2) + (137 x 2)	(150 x 2) + (137 x 2)
Sound Pressure Level	Cooling	dB(A)	61	61	61
	Heating	dB(A)	64	64	63
Sound Power Level	Cooling	dB(A)	73	73	75
	Heating	dB(A)	76	76	77
Communication Cable	mm ² x No. (VCTF-SB)		1.0 - 1.5 x 2C	1.0 - 1.5 x 2C	1.0 - 1.5 x 2C
Refrigerant	Refrigerant Name		R410A	R410A	R410A
	Precharged Amount in Factory		17.6	17.6	17.6
	t-CO ₂ eq		36.740	36.740	36.740
Control			Electronic Expansion Valve	Electronic Expansion Valve	Electronic Expansion Valve
Power Supply	Ø, V, Hz		3, 380-415, 50	3, 380-415, 50	3, 380-415, 50
Number of Maximum Connectable Indoor Units			64	64	64

- Note
- Maximum numbers are prepared based on assumption that all 2.2kW indoor units are connected. The numbers in parentheses means maximum connectable indoor units in accordance with outdoor units combination (160% - 200%). The recommended ratio is 130%.
 - Due to our policy of innovation some specifications may be changed without notification
 - Performances are based on the following conditions
 - Cooling : Indoor temp 27°C (80.6°F) DB / 19°C (66.2°F) WB, Water inlet temp 30°C (86°F)
 - Heating : Indoor temp 20°C (68°F) DB, Water inlet temp 20°C (68°F)
 - Interconnected Pipe Length is 7.5m and difference of Elevation (Outdoor - Indoor Unit) is 0m.
 - Sound pressure level is measured on the rated condition in the anechoic rooms by ISO 3745 standard. Sound power level is measured on the rated condition in the reverberation rooms by ISO 3741 standard. Therefore, these values can be increased owing to ambient conditions during operation.
 - This product contains Fluorinated Greenhouse Gases. (R410A, GWP (Global warming potential) = 2,087.5)
 - Add an anti freeze to circulation water when outdoor unit is operating under 10°C (50°F), and change the DIP switch on main PCB. (For more information on installation section.)

ARWB700LAS4 / ARWB740LAS4
ARWB800LAS4



HP			70	74	80
Model Name	Combination Unit		ARWB700LAS4	ARWB740LAS4	ARWB800LAS4
	Independent Unit		ARWB200LAS4 ARWB200LAS4 ARWB200LAS4 ARWB100LAS4	ARWB200LAS4 ARWB200LAS4 ARWB200LAS4 ARWB140LAS4	ARWB200LAS4 ARWB200LAS4 ARWB200LAS4 ARWB200LAS4
Capacity	Cooling (Rated)	kW	196.0	207.2	224.0
	Heating (Rated)	kW	220.5	233.1	252.0
Input	Cooling (Rated)	kW	38.69	41.44	44.80
	Heating (Rated)	kW	40.35	43.18	46.68
EER			5.07	5.00	5.00
COP	Rated Capacity		5.46	5.40	5.40
Exterior	Color		Warm Gray / Morning Gray	Warm Gray / Morning Gray	Warm Gray / Morning Gray
	RAL Code (Classic)		RAL 7044 / RAL 7030	RAL 7044 / RAL 7030	RAL 7044 / RAL 7030
Heat Exchanger	Type		Stainless Steel Plate	Stainless Steel Plate	Stainless Steel Plate
	Maximum Pressure Resistance	kgf/cm ²	45	45	45
	Head Loss	kPa	30.1 + 30.1 + 30.1 + 15.8	30.1 + 30.1 + 30.1 + 28.6	30.1 + 30.1 + 30.1 + 30.1
	Rated Water Flow	LPM	192 + 192 + 192 + 96	192 + 192 + 192 + 135	192 + 192 + 192 + 192
Compressor	Type		Hermetically Sealed Scroll	Hermetically Sealed Scroll	Hermetically Sealed Scroll
	Combination x No.		(Inverter) x 4	(Inverter) x 4	(Inverter) x 4
	Motor Output x Number	W x No.	5,300 x 3 + 4,200 x 1	5,300 x 3 + 4,200 x 1	5,300 x 4
	Oil Type		FVC68D (PVE)	FVC68D (PVE)	FVC68D (PVE)
	Oil Charge	cc	11,800	11,800	12,000
Refrigerant Connecting Pipes	Liquid Pipe	mm (inch)	Ø22.2 (7/8)	Ø22.2 (7/8)	Ø22.2 (7/8)
	Low Pressure Gas Pipe	mm (inch)	Ø53.98 (2-1/8)	Ø53.98 (2-1/8)	Ø53.98 (2-1/8)
	High Pressure Gas Pipe	mm (inch)	Ø44.5 (1-3/4)	Ø44.5 (1-3/4)	Ø44.5 (1-3/4)
Water Connecting Pipes	Inlet	A (inch)	40A (PT 1-1/2) + 40A (PT 1-1/2) + 40A (PT 1-1/2) + PT40 (Internal Thread)	40A (PT 1-1/2) + 40A (PT 1-1/2) + 40A (PT 1-1/2) + PT40 (Internal Thread)	40A (PT 1-1/2) + 40A (PT 1-1/2) + 40A (PT 1-1/2) + PT40 (Internal Thread)
	Outlet	A (inch)	40A (PT 1-1/2) + 40A (PT 1-1/2) + 40A (PT 1-1/2) + PT40 (Internal Thread)	40A (PT 1-1/2) + 40A (PT 1-1/2) + 40A (PT 1-1/2) + PT40 (Internal Thread)	40A (PT 1-1/2) + 40A (PT 1-1/2) + 40A (PT 1-1/2) + PT40 (Internal Thread)
	Drain Outlet	A (inch)	20A (PT 3/4) (External Thread)	20A (PT 3/4) (External Thread)	20A (PT 3/4) (External Thread)
Dimensions (W x H x D)	mm x No.		(755 x 997 x 500) x 4	(755 x 997 x 500) x 4	(755 x 997 x 500) x 4
Dimensions (W x H x D) - Shipping	mm x No.		(804 x 1,143 x 630) x 4	(804 x 1,143 x 630) x 4	(804 x 1,143 x 630) x 4
Net Weight	kg x No.		(140 x 3) + (127 x 1)	(140 x 3) + (127 x 1)	140 x 4
Shipping Weight	kg x No.		(150 x 3) + (137 x 1)	(150 x 3) + (137 x 1)	150 x 4
Sound Pressure Level	Cooling	dB(A)	59	61	57
	Heating	dB(A)	65	63	63
Sound Power Level	Cooling	dB(A)	71	75	71
	Heating	dB(A)	77	77	77
Communication Cable	mm ² x No. (VCTF-SB)		1.0 - 1.5 x 2C	1.0 - 1.5 x 2C	1.0 - 1.5 x 2C
Refrigerant	Refrigerant Name		R410A	R410A	R410A
	Precharged Amount in Factory		14.8	14.8	12.0
	t-CO ₂ eq		30.895	30.895	25.050
	Control		Electronic Expansion Valve	Electronic Expansion Valve	Electronic Expansion Valve
Power Supply	Ø, V, Hz		3, 380-415, 50	3, 380-415, 50	3, 380-415, 50
Number of Maximum Connectable Indoor Units			64	64	64

- Note
- Maximum numbers are prepared based on assumption that all 2.2kW indoor units are connected. The numbers in parentheses means maximum connectable indoor units in accordance with outdoor units combination (160% - 200%). The recommended ratio is 130%.
 - Due to our policy of innovation some specifications may be changed without notification.
 - Performances are based on the following conditions
 - Cooling : Indoor temp 27°C (80.6°F) DB / 19°C (66.2°F) WB, Water inlet temp 30°C (86°F)
 - Heating : Indoor temp 20°C (68°F) DB, Water inlet temp 20°C (68°F)
 - Interconnected Pipe Length is 7.5m and difference of Elevation (Outdoor - Indoor Unit) is 0m.
 - Sound pressure level is measured on the rated condition in the anechoic rooms by ISO 3745 standard. Sound power level is measured on the rated condition in the reverberation rooms by ISO 3741 standard. Therefore, these values can be increased owing to ambient conditions during operation.
 - This product contains Fluorinated Greenhouse Gases (R410A, GWP (Global warming potential) = 2,087.5)
 - Add an anti freeze to circulation water when outdoor unit is operating under 10°C (50°F), and change the DIP switch on main PCB. (For more information on installation section.)

118 - 191

INDOOR UNITS

WALL MOUNTED / CEILING MOUNTED CASSETTE / CEILING MOUNTED ROUND CASSETTE /
CEILING CONCEALED DUCT / FRESH AIR INTAKE / CEILING & FLOOR CONVERTIBLE /
CEILING SUSPENDED / CONSOLE & FLOOR STANDING / COMPATIBILITY / FEATURE FUNCTIONS

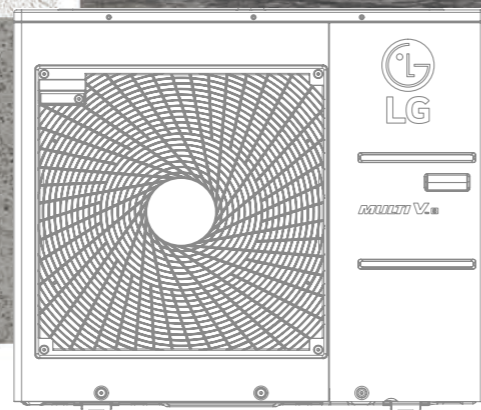
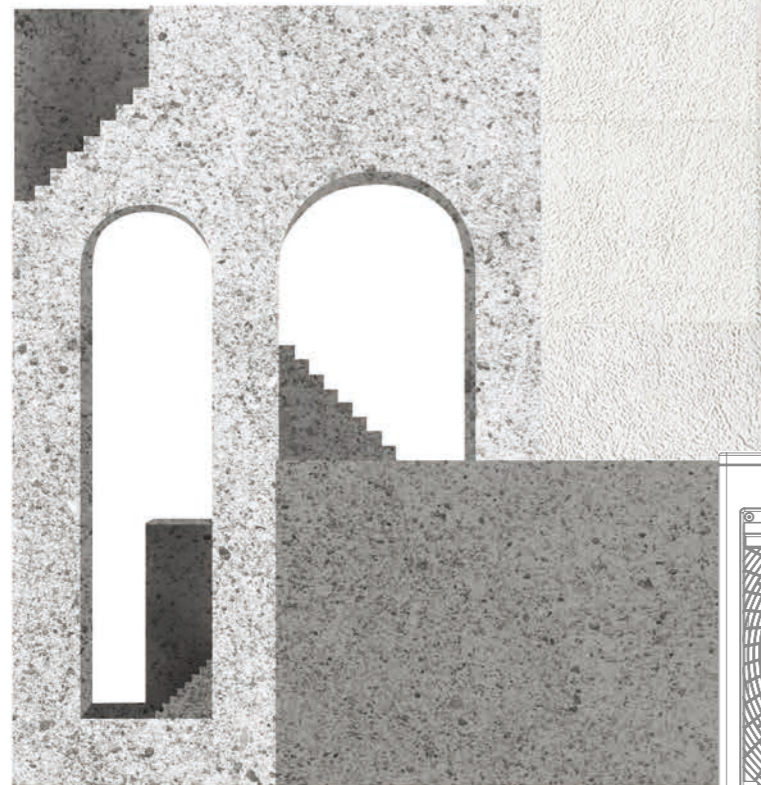
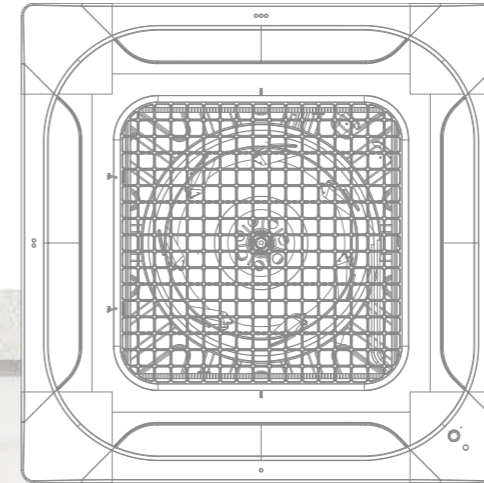



Features & Benefits

- 6 Different discharge angles can be programmed via the remote controller.
- Easily detachable full surface cover helps to clean the air conditioner.
- Drain pipe can be easily hidden from sight.

Key Applications

- Retail
- Hotel
- Restaurant
- Multi-family Residence
- Office

	WALL MOUNTED	ARTCOOL MIRROR	ARTCOOL GALLERY	STANDARD
Smart	Wi-Fi	○	○	○
Energy Efficiency	Energy Display	○	○	○
Fast Cooling & Heating	Jet Cool	○	○	○
	Auto Swing (Up & Down)	○	○	○
Health	Ionizer	○	-	○ ~7.1kW Only
	Pre Filter	○	○	○
	Auto Cleaning	○	○	○
Comfort	Sleep Mode	○	○	○
	Timer (On / Off)	○	○	○
	Timer (Weekly)	○	○	○
	Two Thermistor Control	○	○	○
	Group Control	○	○	○

※ ○: Applied, -: Not applied

Wi-Fi Control

Anytime, anywhere access to the unit with Android & iOS-based smartphones.



LG ThinQ

Search "LG ThinQ" on Google market or the App Store to download the app.

Integrated Home Appliances Control

Control / Monitor all your LG appliances from one place.



Easy Registration and Log-in

Follow the easy set-up steps that will activate LG ThinQ's user-friendly features.

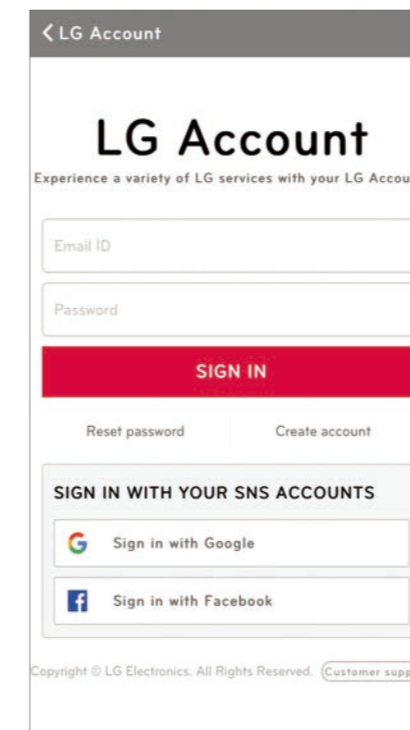

Simple operation for various functions



Straight forward Management

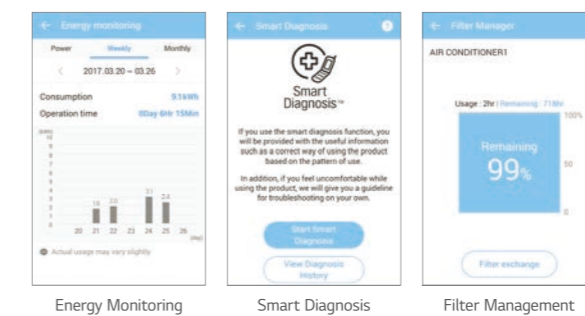
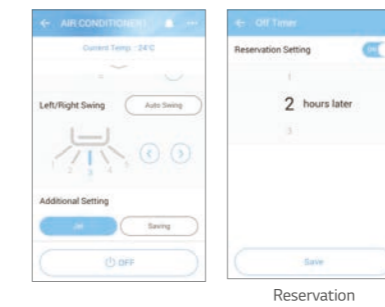

Wi-Fi Control

Anytime, anywhere access to the unit with Android & iOS-based smartphones.



LG ThinQ

Search "LG ThinQ" on Google market or the App Store to download the app.

Access your air conditioner anytime and from anywhere
with a Wi-Fi equipped device and LG's exclusive control app, LG ThinQ.



Wi-Fi Connectivity

Each user can set and save temperature and fan speed preferences in the LG ThinQ app. If a household has more than one indoor unit, separate temperature settings can be set for each.

Multiple Devices



※ Can be controlled by multiple users, but not simultaneously.

Multi-Control

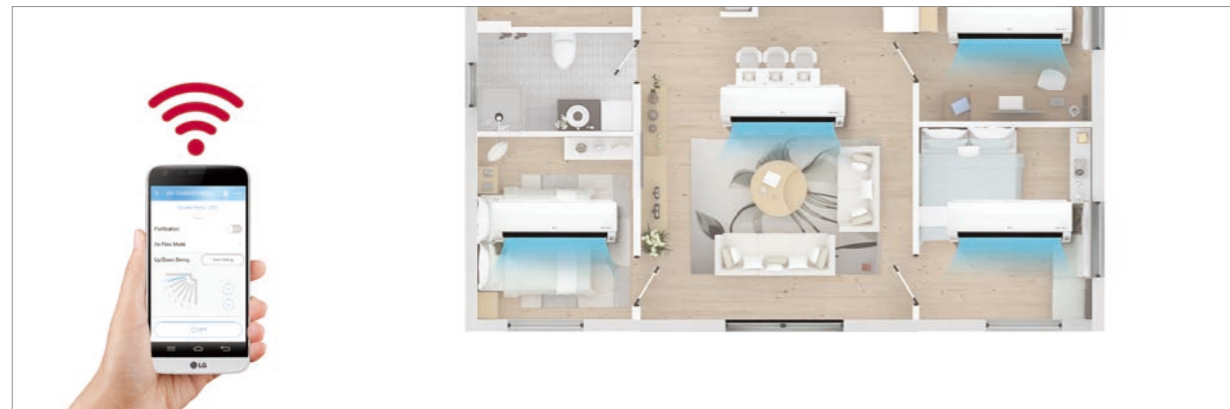

Ionizer^{PLUS}

The powerful Ionizer protects you from bad odors and Escherichia coli and Staphylococcus in the surface with over 3 million ions to reduce to make a safer, and cleaner environment.

※ Specifications may vary for each model.
※ Depending on the experimental conditions.

Reduction and Deodorization (Utilizes Over 3 Million Ions)

Ionizer+ reduces E.coli and Staphylococcus in the surface with over 3 million ions.

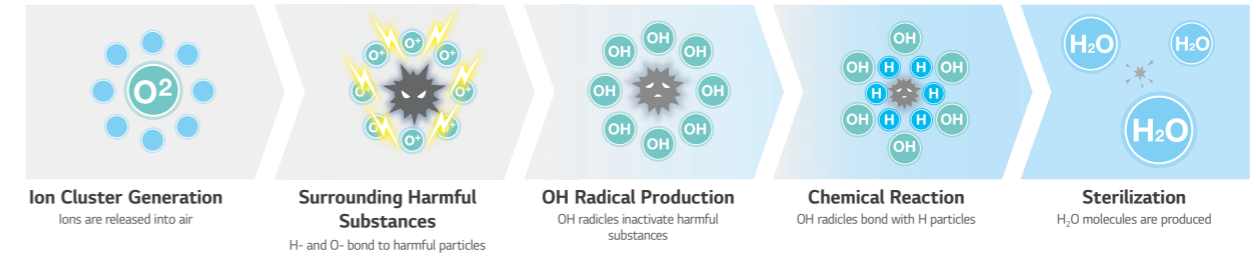

Reduction Performance Evaluations

Reduce Bacteria E.coli over 99.9% in 30 min. and staphylococcus over 99.6% in 60min.

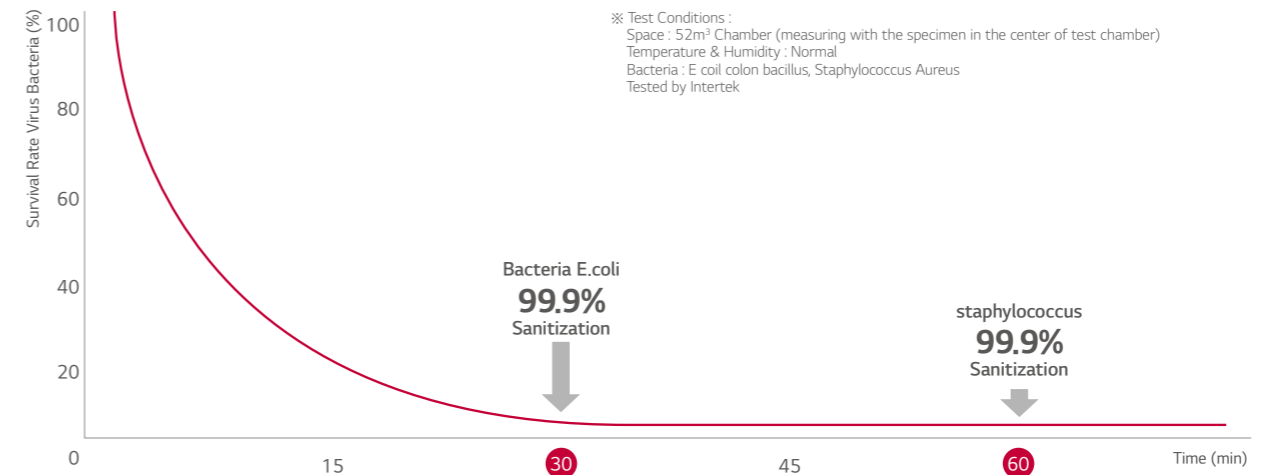

2.1 odor strength decrease in 60 minutes

An odor of measured as 2 European odor units (ouE/m³) or less indicates that the level of odor falls within permissible limits.

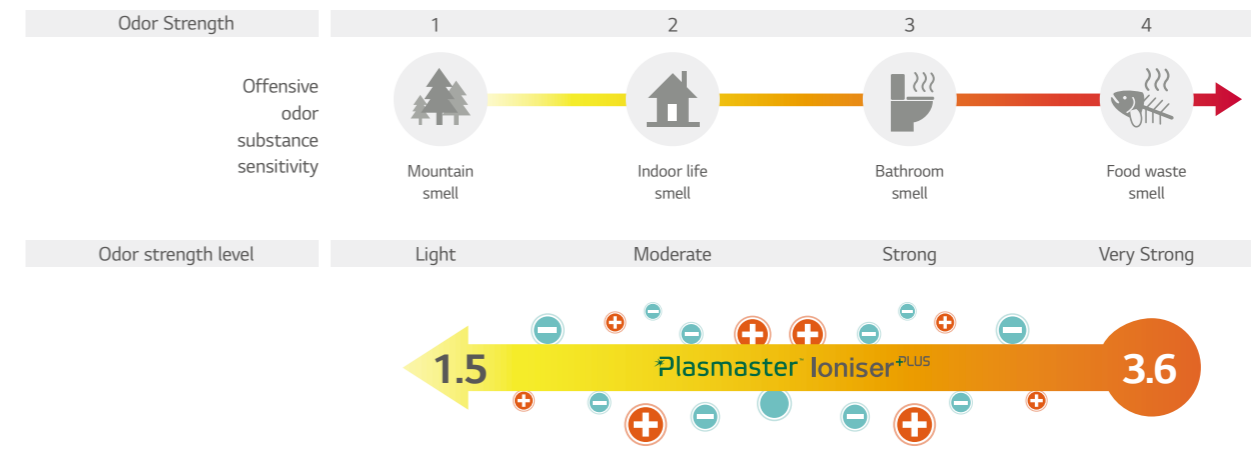

Odor strength reduce 3.6 → 1.5 / The Odor floating in the room as well as curtain and clothes.

※ Test conditions : Space: 8m³ Chamber
Temperature & Humidity : Normal
Tested by Intertek

Auto Cleaning

The unit has a self-cleaning function that dries the heat exchanger before cleaning the interior.

Pain Point

The main cause of odor within air conditioners is mold and bacteria growing on the heat exchanger. These germs can spread when the heat exchanger is wet.



Cleans Filter with Regular Airflow

The comprehensive auto cleaning function prevents the formation of bacteria and mold on the heat exchanger.

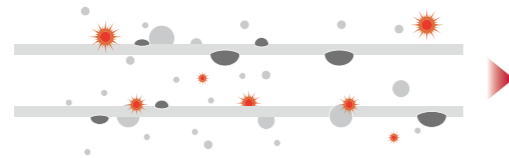

By dehumidifying, (Some models are by dehumidifying and ionizing), the auto cleaning function prevents potentially harmful substances from forming on the surface of the heat exchanger.

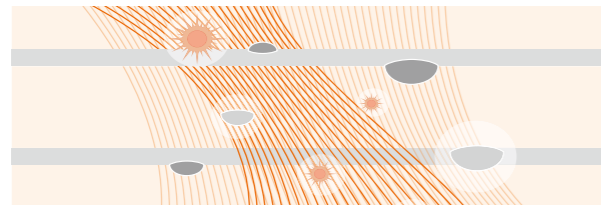

The indoor environment remains odorless with the advanced deodorizing function.



By preventing pollution of the heat exchanger caused by various germs and bacteria, performance and lifespan of the air conditioner can be increased by 10 years.

Installation Support Clip

A support clip creates adequate space between the wall and the unit for easier installation.

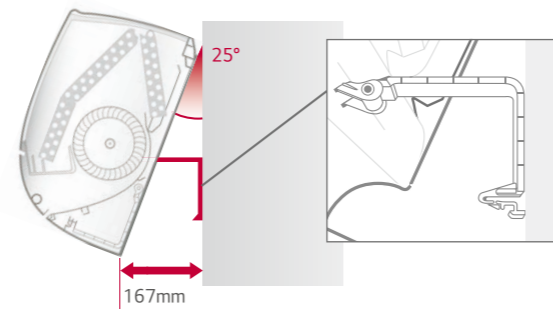

Auto Swing

Cool air extends to the entire room regardless of where the unit is situated.

※ Specifications may vary for each model.

6-Step Vane Control up to 70°

The vertical vane, which moves up and down, has 6 different settings including full-auto swing.

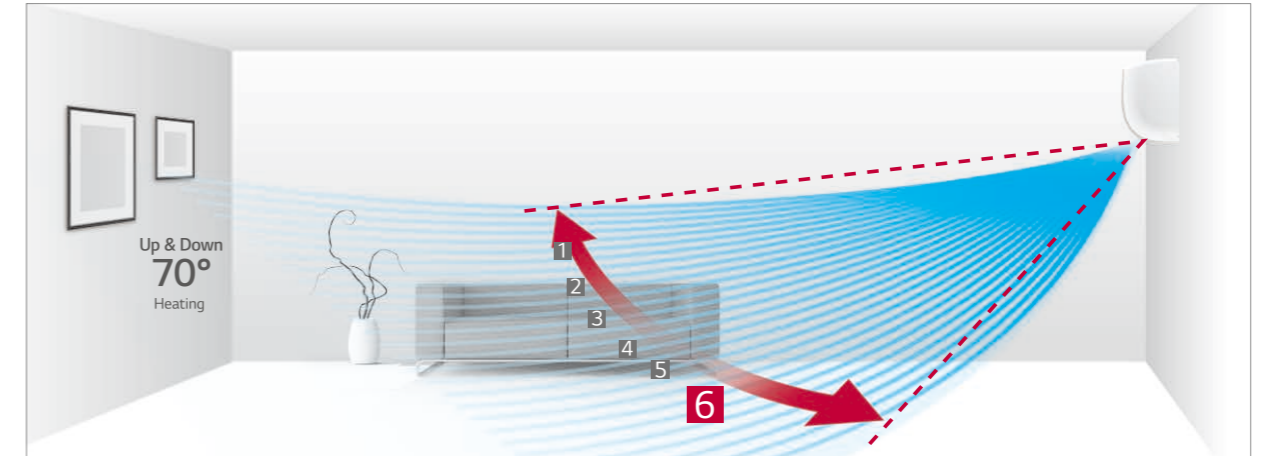

※ Angle can be different from each model and working mode.

Control up to 110°

Louver can be adjusted manually to extend left and right swing to 110 degrees.

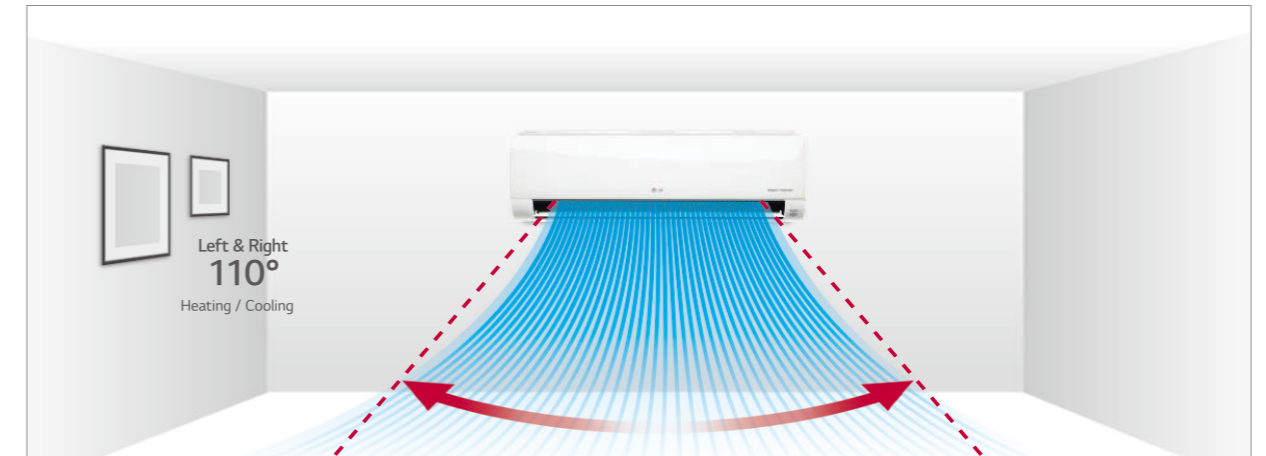

※ Angle can be different from each model and working mode.

Easy and Simple Control

Airflow direction can be changed by LG ThinQ Wi-Fi app.

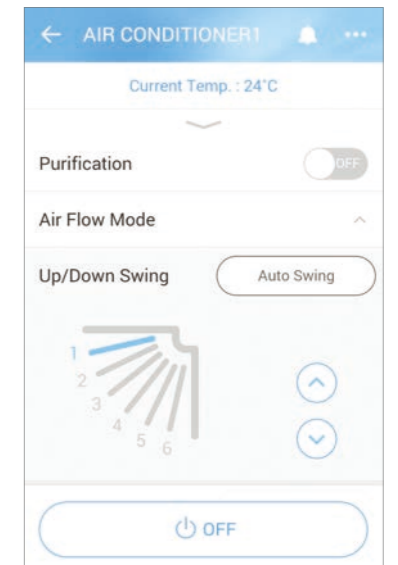

Up / Down Swing

Jet Cool

LG air conditioners provide optimized high-speed airflow, which can cool rooms faster while delivering cool air evenly in every direction.

※ Specifications may vary for each model.
 ※ Depending on the experimental conditions.

One Click "Jet Mode"

Reduces the temperature of outflowing air to 18°C for 30 minutes with just one click.

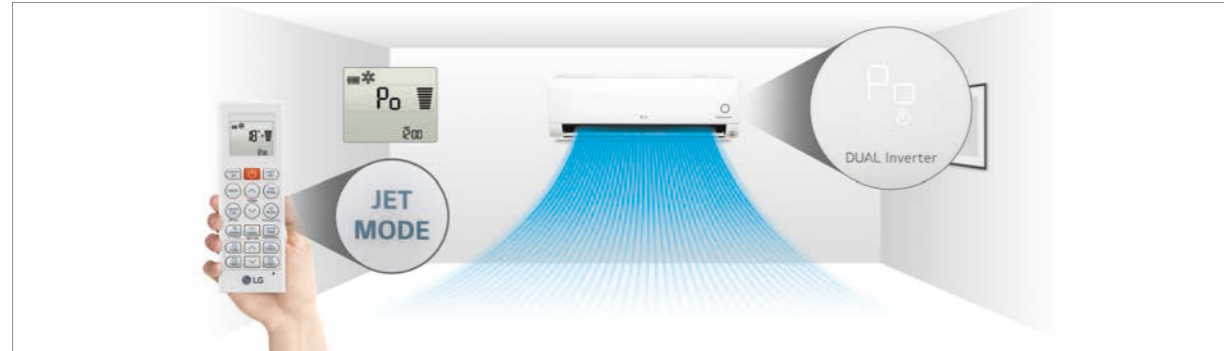

More Powerful Performance

By reducing the second vortex, which decreases airflow within the air outlet, and enlarging the fan size, the amount of air flow is increased to 13 CMM.



Scheduled Operation

You can set the daily temperature, fan speed, the operation mode and automatic On / Off time for two weeks. It will keep running on that time until cancelled by the user.

※ This function is for wired remote controller only.
 ※ Wired remote controller is need to be separately purchased.

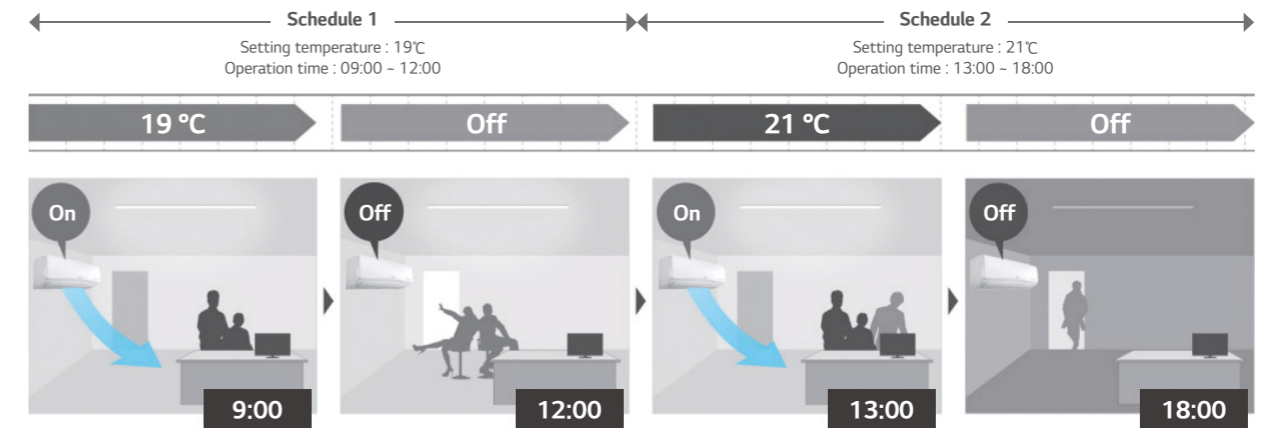

Two Thermistors Control

The indoor temperature can be checked using the thermistors in the remote controller as well as from the indoor unit. There may be a significant difference between ceiling and floor air temperature. Two thermistors can optimise indoor air temperature for a more comfortable environment.



Group Control

Group control by new remote controller (PREMTB100 /PREMTBB10) has more functions than previous model.



ARNU05GSJR4 / ARNU07GSJR4
ARNU09GSJR4 / ARNU12GSJR4
ARNU15GSJR4



MODEL		UNIT	ARNU05GSJR4	ARNU07GSJR4	ARNU09GSJR4	ARNU12GSJR4	ARNU15GSJR4
Cooling Capacity		kW	1.6	2.2	2.8	3.6	4.5
Heating Capacity		kW	1.8	2.5	3.2	4.0	5.0
Power Input (H / M / L) Nominal		W	11 / 10 / 9	12 / 11 / 9	13 / 12 / 9	15 / 13 / 11	23 / 18 / 11
Exterior Color			Mirror (Black)	Mirror (Black)	Mirror (Black)	Mirror (Black)	Mirror (Black)
RAL Code			RAL 9005	RAL 9005	RAL 9005	RAL 9005	RAL 9005
Dimensions (W x H x D)	Body	mm	837 x 308 x 192	837 x 308 x 192	837 x 308 x 192	837 x 308 x 192	837 x 308 x 192
	Shipping	mm	909 x 383 x 256	909 x 383 x 256	909 x 383 x 256	909 x 383 x 256	909 x 383 x 256
Fan							
Type			Cross Flow Fan	Cross Flow Fan	Cross Flow Fan	Cross Flow Fan	Cross Flow Fan
Motor Output x Number		W x No.	30 x 1	30 x 1	30 x 1	30 x 1	30 x 1
Air Flow Rate (H / M / L)		m ³ /min	6.8 / 6.5 / 5.9	7.2 / 6.8 / 5.9	7.8 / 7.2 / 5.9	8.5 / 7.8 / 6.8	10.5 / 9.5 / 6.8
Motor Type			BLDC	BLDC	BLDC	BLDC	BLDC
Air Filter			Pre Filter	Pre Filter	Pre Filter	Pre Filter	Pre Filter
Pipe Connections	Liquid Side	mm (inch)	Ø6.35 (1/4)	Ø6.35 (1/4)	Ø6.35 (1/4)	Ø6.35 (1/4)	Ø6.35 (1/4)
	Gas Side	mm (inch)	Ø12.7 (1/2)	Ø12.7 (1/2)	Ø12.7 (1/2)	Ø12.7 (1/2)	Ø12.7 (1/2)
	Drain Pipe (Internal Dia.)	mm (inch)	Ø16 (5/8)	Ø16 (5/8)	Ø16 (5/8)	Ø16 (5/8)	Ø16 (5/8)
Weight	Body	kg	9.2	9.2	9.2	9.2	9.2
Sound Pressure Levels (H / M / L)		dB(A)	30 / 29 / 28	32 / 30 / 28	34 / 32 / 28	37 / 34 / 30	42 / 39 / 32
Sound Power Levels (H / M / L)		dB(A)	54 / 53 / 52	54 / 53 / 52	55 / 54 / 52	55 / 54 / 53	58 / 56 / 54
Power Supply		Ø, V, Hz	1, 220-240, 50	1, 220-240, 50	1, 220-240, 50	1, 220-240, 50	1, 220-240, 50
Transmission Cable		mm ²	1.0 - 1.5 x 2C	1.0 - 1.5 x 2C	1.0 - 1.5 x 2C	1.0 - 1.5 x 2C	1.0 - 1.5 x 2C

Note :

- Performance tested under EN14511
- Capacities are based on the following conditions
 - Cooling : Indoor temp. 27°C (80.6°F) DB / 19°C (66.2°F) WB, Outdoor temp. 35°C (95°F) DB / 24°C (75.2°F) WB, Interconnecting piping length 7.5m, Level difference of zero
 - Heating : Indoor temp. 20°C (68°F) DB / 15°C (59°F) WB, Outdoor temp. 7°C (44.6°F) DB / 6°C (42.8°F) WB, Interconnecting piping length 7.5m, Level difference of zero
- Due to our policy of innovation, some specifications may be changed without notification

Accessories

CHASSIS	ARNU05GSJR4	ARNU07GSJR4	ARNU09GSJR4	ARNU12GSJR4	ARNU15GSJR4
Drain Pump			-		
Cassette Cover			-		
Refrigerant Leakage Detector			PRLDNV50		
EEV Kit			PRGK024A0		
Independent Power Module			PRIPO		
Robot Cleaner			-		
Pre Filter (Washable)			○		
Ion Generator			○		
CO ₂ Sensor			-		
Ventilation Kit			-		
IR Receiver			-		
Zone Controller			-		
Dry Contact (with additional accessory)			PDRYCB000 (1 point contact), PDRYCB300 (8 points for thermostat compatible), PDRYCB320 (Universal input), PDRYCB400 (2 points input), PDRYCB500 (Modbus)		
External Input (1 point)			○		
Wi-Fi			○		

※ ○ : Applied, - : Not applied
Option : Refer to model name in table

ARNU18GSKR4 / ARNU24GSKR4



MODEL		UNIT	ARNU18GSKR4	ARNU24GSKR4
Cooling Capacity		kW	5.6	7.1
Heating Capacity		kW	6.3	7.5
Power Input (H / M / L) Nominal		W	32 / 26 / 16	39 / 26 / 16
Exterior Color			Mirror (Black)	Mirror (Black)
RAL Code			RAL 9005	RAL 9005
Dimensions (W x H x D)	Body	mm	998 x 345 x 212	998 x 345 x 212
	Shipping	mm	1,080 x 422 x 281	1,080 x 422 x 281
Fan				
Type			Cross Flow Fan	Cross Flow Fan
Motor Output x Number		W x No.	58 x 1	58 x 1
Air Flow Rate (H / M / L)		m ³ /min	14.0 / 12.0 / 10.5	14.0 / 12.0 / 10.5
Motor Type			BLDC	BLDC
Air Filter			Pre Filter	Pre Filter
Pipe Connections	Liquid Side	mm (inch)	Ø6.35 (1/4)	Ø9.52 (3/8)
	Gas Side	mm (inch)	Ø12.7 (1/2)	Ø15.88 (5/8)
	Drain Pipe (Internal Dia.)	mm (inch)	Ø16(5/8)	Ø16(5/8)
Weight	Body	kg	13.4	13.4
Sound Pressure Levels (H / M / L)		dB(A)	43 / 39 / 34	46 / 41 / 34
Sound Power Levels (H / M / L)		dB(A)	63 / 57 / 54	65 / 60 / 54
Power Supply		Ø, V, Hz	1, 220-240, 50	1, 220-240, 50
Transmission Cable		mm ²	1.0 - 1.5 x 2C	1.0 - 1.5 x 2C

Note :

- Performance tested under EN14511
- Capacities are based on the following conditions
 - Cooling : Indoor temp. 27°C (80.6°F) DB / 19°C (66.2°F) WB, Outdoor temp. 35°C (95°F) DB / 24°C (75.2°F) WB, Interconnecting piping length 7.5m, Level difference of zero
 - Heating : Indoor temp. 20°C (68°F) DB / 15°C (59°F) WB, Outdoor temp. 7°C (44.6°F) DB / 6°C (42.8°F) WB, Interconnecting piping length 7.5m, Level difference of zero
- Due to our policy of innovation, some specifications may be changed without notification

Accessories

CHASSIS	ARNU18GSKR4	ARNU24GSKR4	
Drain Pump		-	
Cassette Cover		-	
Refrigerant Leakage Detector		PRLDNV50	
EEV Kit		PRGK024A0	
Independent Power Module		PRIPO	
Robot Cleaner		-	
Pre Filter (Washable)		○	
Ion Generator		○	
CO ₂ Sensor		-	
Ventilation Kit		-	
IR Receiver		-	
Zone Controller		-	
Dry Contact (with additional accessory)		PDRYCB000 (1 point contact), PDRYCB300 (8 points for thermostat compatible), PDRYCB320 (Universal input), PDRYCB400 (2 points input), PDRYCB500 (Modbus)	
External Input (1 point)		○	
Wi-Fi		○	

※ ○ : Applied, - : Not applied
Option : Refer to model name in table

ARNU07GSF14 / ARNU09GSF14
ARNU12GSF14



MODEL	UNIT	ARNU07GSF14	ARNU09GSF14	ARNU12GSF14	
Cooling Capacity	kW	2.2	2.8	3.6	
Heating Capacity	kW	2.5	3.2	4.0	
Power Input (H / M / L)	Nominal	28 / 16 / 10	28 / 16 / 10	32 / 20 / 12	
	W				
Dimensions (W x H x D)	Body	600 x 600 x 146	600 x 600 x 146	600 x 600 x 146	
	Shipping	685 x 670 x 215	685 x 670 x 215	685 x 670 x 215	
Fan	Type	Turbo Fan	Turbo Fan	Turbo Fan	
	Motor Output x Number	W x No.	30 x 1	30 x 1	
	Air Flow Rate (H / M / L)	m ³ /min	8.1 / 6.3 / 4.2	8.1 / 6.3 / 4.2	9.3 / 7.7 / 6.0
	Motor Type		BLDC	BLDC	
Air Filter		Pre Filter	Pre Filter	Pre Filter	
Pipe Connections	Liquid Side	mm (inch)	Ø6.35 (1/4)	Ø6.35 (1/4)	
	Gas Side	mm (inch)	Ø12.7 (1/2)	Ø12.7 (1/2)	
	Drain Pipe (Internal Dia.)	mm (inch)	Ø12 (15/32)	Ø12 (15/32)	
Weight	Body	kg	15.0	15.0	
Sound Pressure Levels (H / M / L)		dB(A)	38 / 32 / 27	38 / 32 / 27	44 / 38 / 32
Sound Power Levels (H / M / L)		dB(A)	48 / 46 / 41	48 / 46 / 41	54 / 46 / 38
Power Supply	Ø, V, Hz		1, 220-240, 50	1, 220-240, 50	1, 220-240, 50
Transmission Cable		mm ²	1.0 - 1.5 x 2C	1.0 - 1.5 x 2C	1.0 - 1.5 x 2C

Note :
 1. Performance tested under EN14511
 2. Capacities are based on the following conditions
 - Cooling : Indoor temp. 27°C (80.6°F) DB / 19°C (66.2°F) WB, Outdoor temp. 35°C (95°F) DB / 24°C (75.2°F) WB, Interconnecting piping length 7.5m, Level difference of zero
 - Heating : Indoor temp. 20°C (68°F) DB / 15°C (59°F) WB, Outdoor temp. 7°C (44.6°F) DB / 6°C (42.8°F) WB, Interconnecting piping length 7.5m, Level difference of zero
 3. Due to our policy of innovation, some specifications may be changed without notification

Accessories

CHASSIS	ARNU07GSF14	ARNU09GSF14	ARNU12GSF14
Drain Pump		-	
Cassette Cover		-	
Refrigerant Leakage Detector		PRLDNV50	
EEV Kit		PRGK024A0	
Independent Power Module		PRIPO	
Robot Cleaner		-	
Pre Filter (Washable)		○	
Ion Generator		-	
CO ₂ Sensor		-	
Ventilation Kit		-	
IR Receiver		-	
Zone Controller		-	
Dry Contact (with additional accessory)		PDRYCB000 (1 point contact), PDRYCB320 (Universal input), PDRYCB400 (2 points input), PDRYCB500 (Modbus)	
External Input (1 point)		○	
Wi-Fi		PWFMD200 ¹⁾	

※ ○ : Applied, - : Not applied
 Option : Refer to model name in table
 1) External installation only

ARNU05GSJ*4 / ARNU07GSJ*4 / ARNU09GSJ*4
ARNU12GSJ*4 / ARNU15GSJ*4



MODEL	UNIT	ARNU05GSJ*4	ARNU07GSJ*4	ARNU09GSJ*4	ARNU12GSJ*4	ARNU15GSJ*4	
Cooling Capacity	kW	1.6	2.2	2.8	3.6	4.5	
Heating Capacity	kW	1.8	2.5	3.2	4.0	5.0	
Power Input (H / M / L)	Nominal	11 / 10 / 9	12 / 11 / 9	13 / 12 / 9	15 / 13 / 11	23 / 18 / 11	
	W						
Exterior Color		White	White	White	White	White	
RAL Code		RAL 9016	RAL 9016	RAL 9016	RAL 9016	RAL 9016	
Dimensions (W x H x D)	Body	mm	818 x 316 x 189	818 x 316 x 189	818 x 316 x 189	818 x 316 x 189	
	Shipping	mm	892 x 381 x 249	892 x 381 x 249	892 x 381 x 249	892 x 381 x 249	
Fan	Type		Cross Flow Fan	Cross Flow Fan	Cross Flow Fan	Cross Flow Fan	
	Motor Output x Number	W x No.	30 x 1	30 x 1	30 x 1	30 x 1	
	Air Flow Rate (H / M / L)	m ³ /min	6.8 / 6.5 / 5.9	7.2 / 6.8 / 5.9	7.8 / 7.2 / 5.9	8.5 / 7.8 / 6.8	10.5 / 9.5 / 6.8
	Motor Type		BLDC	BLDC	BLDC	BLDC	
Air Filter		Pre Filter	Pre Filter	Pre Filter	Pre Filter	Pre Filter	
Pipe Connections	Liquid Side	mm (inch)	Ø6.35 (1/4)	Ø6.35 (1/4)	Ø6.35 (1/4)	Ø6.35 (1/4)	
	Gas Side	mm (inch)	Ø12.7 (1/2)	Ø12.7 (1/2)	Ø12.7 (1/2)	Ø12.7 (1/2)	
	Drain Pipe (Internal Dia.)	mm (inch)	Ø16 (5/8)	Ø16 (5/8)	Ø16 (5/8)	Ø16 (5/8)	
Weight	Body	kg	8.4	8.4	8.4	8.4	
Sound Pressure Levels (H / M / L)		dB(A)	30 / 29 / 28	32 / 30 / 28	34 / 32 / 28	37 / 34 / 30	42 / 39 / 32
Sound Power Levels (H / M / L)		dB(A)	54 / 53 / 52	54 / 53 / 52	55 / 54 / 52	55 / 54 / 53	58 / 56 / 54
Power Supply	Ø, V, Hz		1, 220-240, 50	1, 220-240, 50	1, 220-240, 50	1, 220-240, 50	
Transmission Cable		mm ²	1.0 - 1.5 x 2C	1.0 - 1.5 x 2C	1.0 - 1.5 x 2C	1.0 - 1.5 x 2C	

* : N or C can be applied which has little bit different shape of panel.
 Note :
 1. Performance tested under EN14511
 2. Capacities are based on the following conditions
 - Cooling : Indoor temp. 27°C (80.6°F) DB / 19°C (66.2°F) WB, Outdoor temp. 35°C (95°F) DB / 24°C (75.2°F) WB, Interconnecting piping length 7.5m, Level difference of zero
 - Heating : Indoor temp. 20°C (68°F) DB / 15°C (59°F) WB, Outdoor temp. 7°C (44.6°F) DB / 6°C (42.8°F) WB, Interconnecting piping length 7.5m, Level difference of zero
 3. Due to our policy of innovation, some specifications may be changed without notification

Accessories

CHASSIS	ARNU05GSJ*4	ARNU07GSJ*4	ARNU09GSJ*4	ARNU12GSJ*4	ARNU15GSJ*4
Drain Pump					
Cassette Cover					
Refrigerant Leakage Detector			PRLDNV50		
EEV Kit			PRGK024A0		
Independent Power Module			PRIPO		
Robot Cleaner			-		
Pre Filter (Washable)			○		
Ion Generator			-		
CO ₂ Sensor			-		
Ventilation Kit			-		
IR Receiver			-		
Zone Controller			-		
Dry Contact (with additional accessory)		PDRYCB000 (1 point contact), PDRYCB320 (Universal input), PDRYCB400 (2 points input), PDRYCB500 (Modbus)			
External Input (1 point)		○			
Wi-Fi		○			

※ ○ : Applied, - : Not applied
 Option : Refer to model name in table

ARNU18GSK*4 / ARNU24GSK*4



MODEL	UNIT	ARNU18GSK*4	ARNU24GSK*4
Cooling Capacity	kW	5.6	7.1
Heating Capacity	kW	6.3	7.5
Power Input (H / M / L)	Nominal W	32 / 26 / 16	39 / 26 / 16
Exterior Color		White	White
RAL Code		RAL 9016	RAL 9016
Dimensions (W x H x D)	Body mm	975 x 354 x 209	975 x 354 x 209
	Shipping mm	1,063 x 420 x 274	1,063 x 420 x 274
Fan	Type	Cross Flow Fan	Cross Flow Fan
	Motor Output x Number W x No.	58 x 1	58 x 1
	Air Flow Rate (H / M / L) m ³ /min	14.0 / 12.0 / 10.5	15.2 / 12.7 / 10.5
	Motor Type	BLDC	BLDC
Air Filter		Pre Filter	Pre Filter
Pipe Connections	Liquid Side mm (inch)	Ø6.35 (1/4)	Ø9.52 (3/8)
	Gas Side mm (inch)	Ø12.7 (1/2)	Ø15.88 (5/8)
	Drain Pipe (Internal Dia.) mm (inch)	Ø16 (5/8)	Ø16 (5/8)
Weight	Body kg	12.2	12.2
Sound Pressure Levels (H / M / L)	dB(A)	43 / 39 / 34	46 / 41 / 34
Sound Power Levels (H / M / L)	dB(A)	63 / 57 / 54	65 / 60 / 54
Power Supply	Ø, V, Hz	1, 220-240, 50	1, 220-240, 50
Transmission Cable	mm ²	1.0 - 1.5 x 2C	1.0 - 1.5 x 2C

* : N or C can be applied which has little bit different shape of panel

Note :

1. Performance tested under EN14511

2. Capacities are based on the following conditions

- Cooling : Indoor temp. 27°C (80.6°F) DB / 19°C (66.2°F) WB, Outdoor temp. 35°C (95°F) DB / 24°C (75.2°F) WB, Interconnecting piping length 7.5m, Level difference of zero

- Heating : Indoor temp. 20°C (68°F) DB / 15°C (59°F) WB, Outdoor temp. 7°C (44.6°F) DB / 6°C (42.8°F) WB, Interconnecting piping length 7.5m, Level difference of zero

3. Due to our policy of innovation, some specifications may be changed without notification

Accessories

CHASSIS	ARNU18GSK*4	ARNU24GSK*4
Drain Pump		-
Cassette Cover		-
Refrigerant Leakage Detector		PRLDNV50
EEV Kit		PRGK024A0
Independent Power Module		PRIP0
Robot Cleaner		-
Pre Filter (Washable)		○
Ion Generator		○
CO ₂ Sensor		-
Ventilation Kit		-
IR Receiver		-
Zone Controller		-
Dry Contact (with additional accessory)		PDRYCB000 (1 point contact), PDRYCB320 (Universal input), PDRYCB400 (2 points input), PDRYCB500 (Modbus)
External Input (1 point)		○
Wi-Fi		○

※ ○ : Applied, - : Not applied
Option : Refer to model name in table

ARNU30GSVA4 / ARNU36GSVA4



MODEL	UNIT	ARNU30GSVA4	ARNU36GSVA4
Cooling Capacity	kW	8.8	10.4
Heating Capacity	kW	9.4	10.8
Power Input (H / M / L)	Nominal W	54 / 43 / 31	85 / 51 / 36
Exterior Color		White	White
RAL Code		RAL 9016	RAL 9016
Dimensions (W x H x D)	Body mm	1,190 x 346 x 265	1,190 x 346 x 265
	Shipping mm	1,265 x 432 x 335	1,265 x 432 x 335
Fan	Type	Cross Flow Fan	Cross Flow Fan
	Motor Output x Number W x No.	113 x 1	113 x 1
	Air Flow Rate (H / M / L) m ³ /min	23.0 / 20.0 / 17.0	26.0 / 23.0 / 19.0
	Motor Type	BLDC	BLDC
Air Filter		Pre Filter	Pre Filter
Pipe Connections	Liquid Side mm (inch)	Ø9.52 (3/8)	Ø9.52 (3/8)
	Gas Side mm (inch)	Ø15.88 (5/8)	Ø15.88 (5/8)
	Drain Pipe (Internal Dia.) mm (inch)	Ø16 (5/8)	Ø16 (5/8)
Weight	Body kg	16.6	16.6
Sound Pressure Levels (H / M / L)	dB(A)	49 / 44 / 42	52 / 47 / 43
Power Supply	Ø, V, Hz	1, 220-240, 50	1, 220-240, 50
Transmission Cable	mm ²	1.0 - 1.5 x 2C	1.0 - 1.5 x 2C

Note :

1. Performance tested under EN14511

2. Capacities are based on the following conditions

- Cooling : Indoor temp. 27°C (80.6°F) DB / 19°C (66.2°F) WB, Outdoor temp. 35°C (95°F) DB / 24°C (75.2°F) WB, Interconnecting piping length 7.5m, Level difference of zero

- Heating : Indoor temp. 20°C (68°F) DB / 15°C (59°F) WB, Outdoor temp. 7°C (44.6°F) DB / 6°C (42.8°F) WB, Interconnecting piping length 7.5m, Level difference of zero

3. Due to our policy of innovation, some specifications may be changed without notification

Accessories

CHASSIS	ARNU30GSVA4	ARNU36GSVA4
Drain Pump		-
Cassette Cover		-
Refrigerant Leakage Detector		PRLDNV50
EEV Kit		-
Independent Power Module		PRIP0
Robot Cleaner		-
Pre Filter (Washable)		○
Ion Generator		-
CO ₂ Sensor		-
Ventilation Kit		-
IR Receiver		-
Zone Controller		-
Dry Contact (with additional accessory)		PDRYCB000 (1 point contact), PDRYCB320 (Universal input), PDRYCB400 (2 points input), PDRYCB500 (Modbus)
External Input (1 point)		○
Wi-Fi		PWFMD200 ¹⁾

※ ○ : Applied, - : Not applied
Option : Refer to model name in table
1) External installation only



4 Way Air Flow with New Design

New Excellent Technology (NET) certifies new 4 way dual vane design that promotes comfortable and convenient airflow.



*New types wind

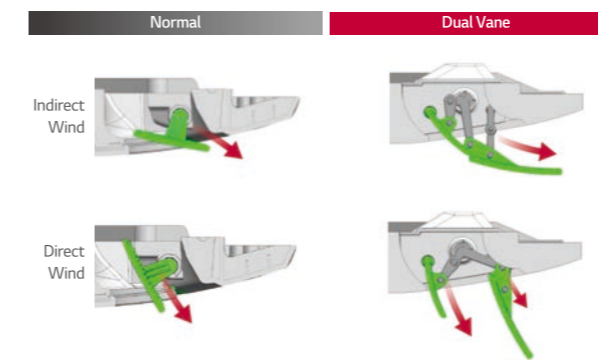

*6 Airflows mode



Brighter Color

Color enhancement allows cassette to blend in to most interior ceiling spaces.



Features & Benefits

- New dual vane 4 way cassette allows comfortable air flow
- Full 3D Turbo fan decreases air resistance, providing high air flow and low sound levels.

Key Applications

- Retail
- School
- Office
- Hotel
- Dormitory
- Restaurant

CASSETTE		4 WAY	2 WAY	1 WAY
Smart	Wi-Fi	○	○	○
Energy Efficiency	Human Detect Sensor	○	-	-
	Drain Pump	○	○	○
Comfort	Sleep Mode	○	○	○
	Timer (On / Off)	○	○	○
	Timer (Weekly)	○	○	○
	Two Thermistor Control	○	○	○
	Group Control	○	○	○

※ ○: Applied, -: Not applied

Wide Design

Bigger inlet and outlet make faster cooling / heating airflow.

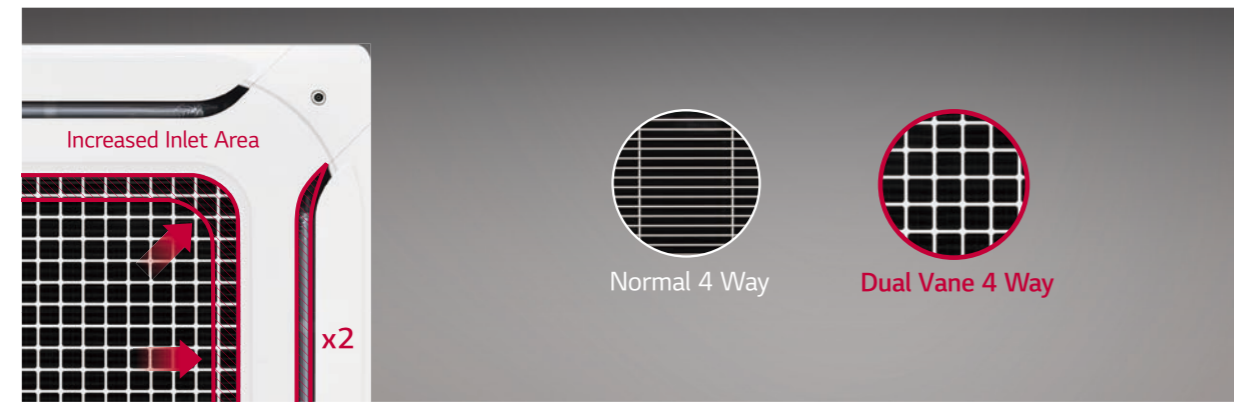

Full 3D Turbo Fan

Full 3D Turbo fan decreases air resistance, so it creates high efficiency and reduces noise level.



High Efficiency Heat Exchanger (HEX)

Ø5 High Density Heat Exchanger increases cooling / heating efficiency by 10%.

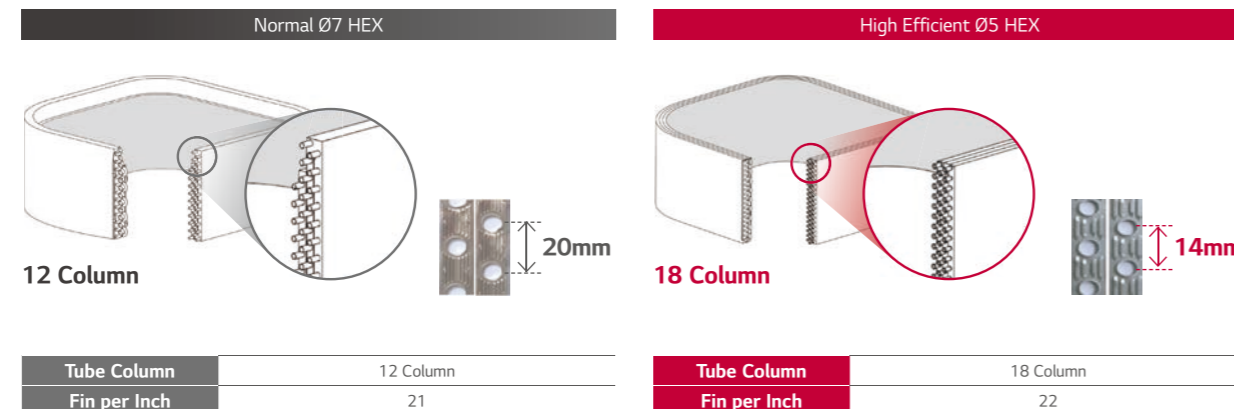

Ceiling to Floor Temperature Sensing

With a special sensor that senses both ceiling and floor temperature, dual vane 4 way cassette provides comfort air.



Human-detection Air Flow

Human detection provides users with direct or indirect air flow preferences.

Indirect comfort

Provides air flow that blows away from user for comfort.



Direct cooling

Provides air flow that blows directly onto user for cooling.



Human Detection for Optimized Efficiency

Indoor unit senses human presence to switch on or off for maximum power savings of 54%.

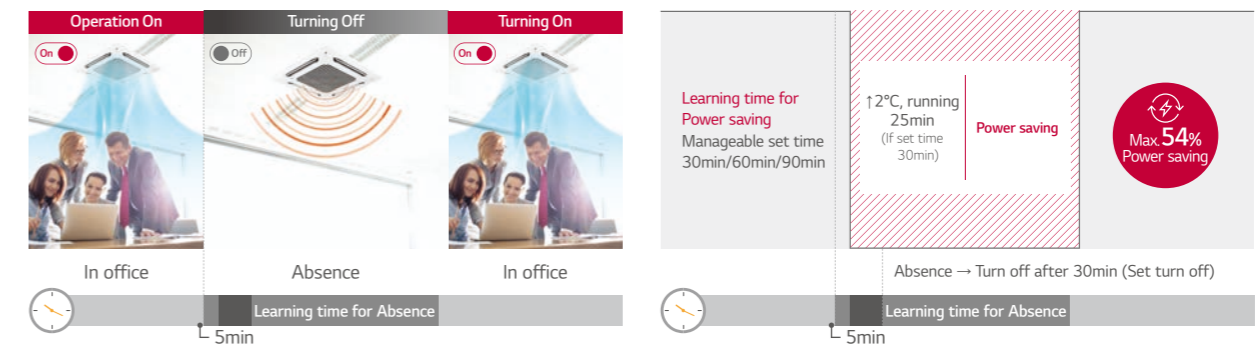

※ Smart Dual Vane Indoor Unit '19 Line up.
 ※ Data Based on actual test of LG, single product 2 hours measurement result. (Cooling 26 °C, strong wind)

High-performance Air Cleaning

Air cleaning function provides fresh, filtered air.



Convenient & Powerful 5-Step Air Purification

Easy-to-manage Air Purification system with one-touch Air Purification filter.

Air Purification kit



Cycle Management

Pre-filter	PM1.0 Filter	Deodorization Filter
Washable	6 months / Washable	6 months / Dry in sunlight

Air Quality Level Display

Wi-Fi functionality for anytime, anywhere indoor unit control and air quality level display.

① IDU LED

Real-time indoor air quality level displayed on indoor unit

② Remote controller

Air quality level displayed on remote controller

③ Mobile

Anytime, anywhere access to check & control air status via mobile

Direct Wind

Warm wind can reach up to 5m with plenty air volume. (@ 0.5ms)



LG ThinQ Connectivity

Grille automatically detaches and re-attaches with 4 touch points for enhanced stability & convenient filter management.



- ① Monitoring Air status : Easy to check indoor air status
 - Ultra Fine / Extra Fine / Fine Dust
 - Day / Week / Month / Yearly
- ② Mobile Remote Control : Remote control by using mobile phone
 - Control Mode / Temperature / Air flow etc.
- ③ Display Power Consumption : Check power consumption of A/C
 - Check energy display
 - Set target energy consumption level

Easy Filter Cleaning for Air Purification

Air Purification Kit filters do NOT need replacement and can be used semi-permanently. Also, thanks to easy maintenance, users can use air purification conveniently without any worries about filter's cleanliness.

Air Purification kit

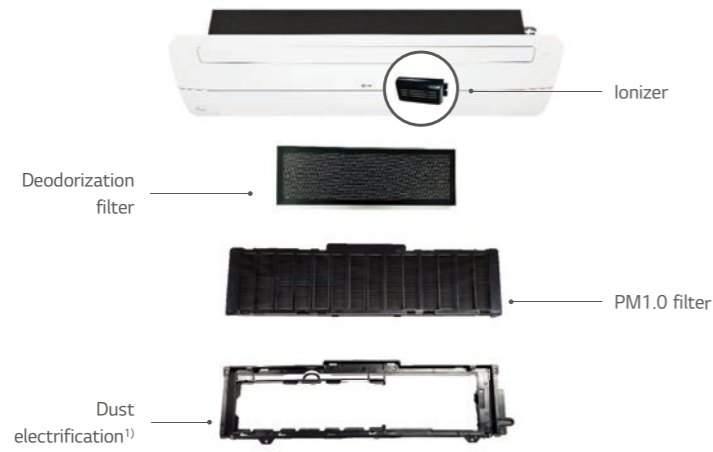

Air Purification panel

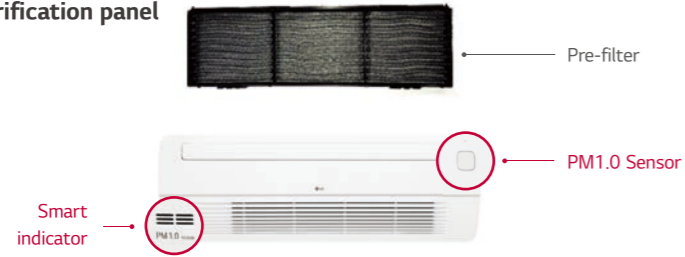

1) It increases the electrostatic force of particle to improve collection efficiency
 ※ Normally HEPA filter type must be replaced regularly. It means that it costs expensive for maintenance.

Direct & Indirect Wind

Provides users with direct or indirect air flow preferences.

Comfort indirect wind

Without touching the skin directly, a large space is comfortable!



With indirect wind, Comfortable!

Cooler on a hot day.



With direct wind, Cooler!

Minimized Height (1 Way)

With a height of 132mm, the LG 1 Way cassette is the ideal solution for limited-space installations.

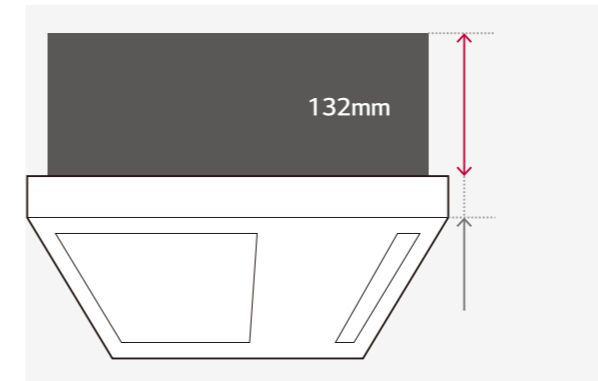

Size Comparison

	A Company	B company	LG
1 Way Cassette	215	230	132

(Unit : mm)

Flexible Installation (1 Way)

1 Way cassette doesn't require the inspection access hole, so that simple installation is possible.

1 Way cassette

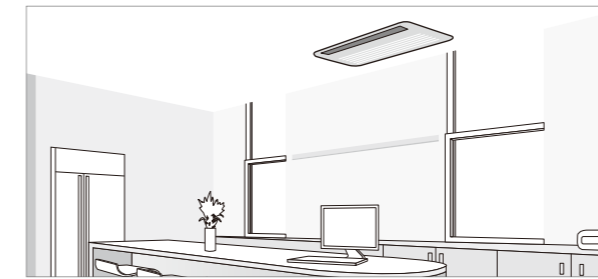

Duct

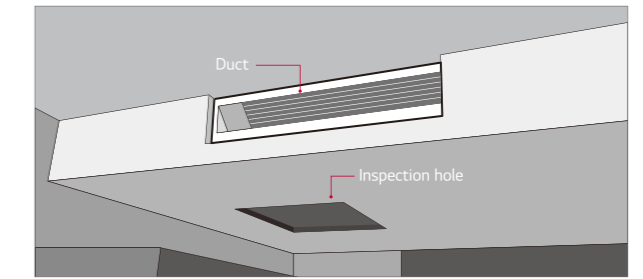

Installation Standard (1 Way)

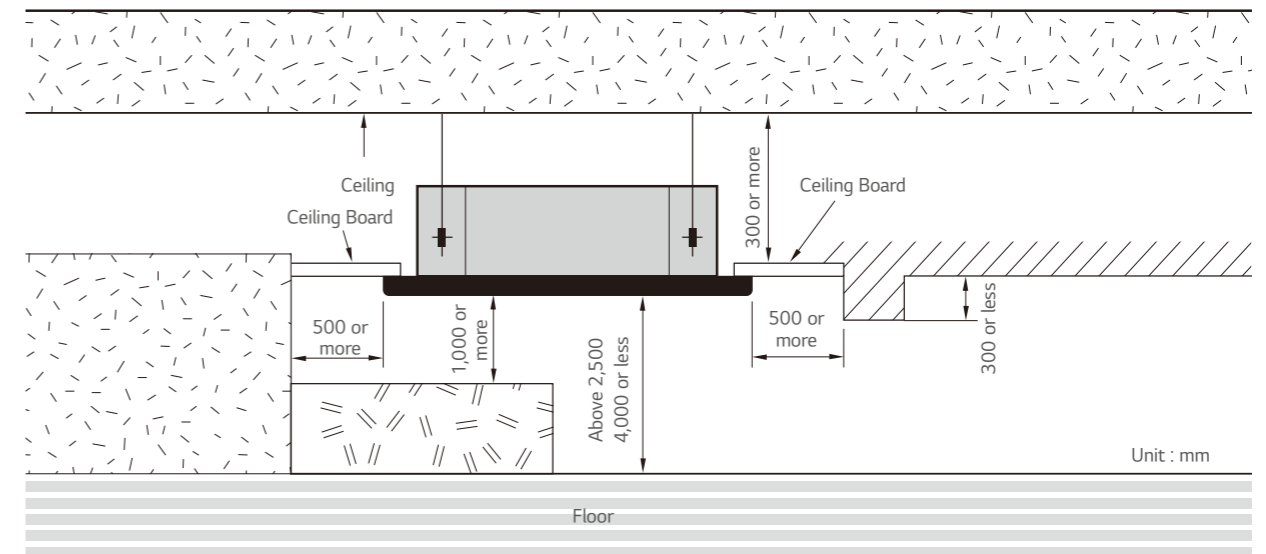

ARNU24GTBB4 / ARNU28GTBB4
ARNU30GTBB4



MODEL		UNIT	ARNU24GTBB4	ARNU28GTBB4	ARNU30GTBB4
Cooling Capacity		kW	7.1	8.2	9.0
Heating Capacity		kW	8.0	9.2	10.0
Power Input (H / M / L)	Nominal	W	32 / 27 / 20	37 / 30 / 22	48 / 36 / 25
	Body	mm	840 x 204 x 840	840 x 204 x 840	840 x 204 x 840
Dimensions (W x H x D)	Shipping	mm	922 x 276 x 917	922 x 276 x 917	922 x 276 x 917
	Type		Full 3D Turbo Fan	Full 3D Turbo Fan	Full 3D Turbo Fan
Fan	Motor Output x Number	W	51 x 1	51 x 1	51 x 1
	Air Flow Rate (H / M / L)	m ³ /min	18 / 17 / 15	19 / 17 / 15	21 / 19 / 16
	Motor Type		BLDC	BLDC	BLDC
	Air Filter		Pre Filter	Pre Filter	Pre Filter
Pipe Connections	Liquid Side	mm (inch)	Ø9.52 (3/8)	Ø9.52 (3/8)	Ø9.52 (3/8)
	Gas Side	mm (inch)	Ø15.88 (5/8)	Ø15.88 (5/8)	Ø15.88 (5/8)
	Drain Pipe (Internal Dia.)	mm (inch)	Ø25 (1)	Ø25 (1)	Ø25 (1)
Weight	Body	kg	21	21	21
Sound Pressure Level (H / M / L)		dB(A)	36 / 34 / 31	39 / 35 / 34	40 / 36 / 33
Sound Power Level (H / M / L)		dB(A)	46 / 44 / 42	50 / 46 / 43	53 / 50 / 45
Power Supply		Ø, V, Hz	1, 220-240, 50	1, 220-240, 50	1, 220-240, 50
Communication Cable (VCTF-SB)		mm ² x cores	1.0 - 1.5 x 2	1.0 - 1.5 x 2	1.0 - 1.5 x 2
	Model Name		PT-AAGW0 PT-AFGW0	PT-AAGW0 PT-AFGW0	PT-AAGW0 PT-AFGW0
Decoration Panel (Accessory)	Exterior Color		White	White	White
	RAL Code		RAL 9003	RAL 9003	RAL 9003
	Net Dimensions (W x H x D)	mm	950 x 35 x 950	950 x 35 x 950	950 x 35 x 950
	Net Weight	kg	7.1 / 7.5 / 8.5	7.1 / 7.5 / 8.5	7.1 / 7.5 / 8.5

Note :
 1. Performance tested under EN14511
 2. Capacities are based on the following conditions
 - Cooling : Indoor temp. 27°C (80.6°F) DB / 19°C (66.2°F) WB, Outdoor temp. 35°C (95°F) DB / 24°C (75.2°F) WB, Interconnecting piping length 7.5m, Level difference of zero
 - Heating : Indoor temp. 20°C (68°F) DB / 15°C (59°F) WB, Outdoor temp. 7°C (44.6°F) DB / 6°C (42.8°F) WB, Interconnecting piping length 7.5m, Level difference of zero
 3. Due to our policy of innovation, some specifications may be changed without notification

Accessories

CHASSIS	ARNU24GTBB4	ARNU28GTBB4	ARNU30GTBB4
Drain Pump		○	
Cassette Cover		PTDCM	
Refrigerant Leakage Detector		PRLDNVSO	
EEV Kit		-	
Independent Power Module		PRIP0	
Robot Cleaner		-	
Pre Filter (Washable)		○	
Ion Generator		-	
CO ₂ Sensor		-	
Ventilation Kit		-	
IR Receiver		-	
Zone Controller		-	
Dry Contact (with additional accessory)		PDRYCB000 (1 point contact), PDRYCB320 (Universal input), PDRYCB400 (2 points input), PDRYCB500 (Modbus)	
External Input (1 Point)		○	
Wi-Fi		PWFMD200	
Human detection sensor		PTVSA00	
Floor Temperature Sensor		PT-AFGW0 :○	
Air cleaning kit		PT-AFGW0 : PTAFMPO	
Elevation Grille		PT-AEGW0 :○	

ARNU36GTAB4 / ARNU42GTAB4
ARNU48GTAB4



MODEL		UNIT	ARNU36GTAB4	ARNU42GTAB4	ARNU48GTAB4
Cooling Capacity		kW	10.6	12.3	14.1
Heating Capacity		kW	11.9	13.8	15.9
Power Input (H / M / L)	Nominal	W	69 / 49 / 37	97 / 69 / 49	110 / 76 / 61
	Body	mm	840 x 288 x 840	840 x 288 x 840	840 x 288 x 840
Dimensions (W x H x D)	Shipping	mm	922 x 360 x 917	922 x 360 x 917	922 x 360 x 917
	Type		Full 3D Turbo Fan	Full 3D Turbo Fan	Full 3D Turbo Fan
Fan	Motor Output x Number	W	135 x 1	135 x 1	135 x 1
	Air Flow Rate (H / M / L)	m ³ /min	29 / 26 / 22	33 / 29 / 26	34 / 30 / 28
	Motor Type		BLDC	BLDC	BLDC
	Air Filter		Pre Filter	Pre Filter	Pre Filter
Pipe Connections	Liquid Side	mm (inch)	Ø9.52 (3/8)	Ø9.52 (3/8)	Ø9.52 (3/8)
	Gas Side	mm (inch)	Ø15.88 (5/8)	Ø15.88 (5/8)	Ø15.88 (5/8)
	Drain Pipe (Internal Dia.)	mm (inch)	Ø25 (1)	Ø25 (1)	Ø25 (1)
Weight	Body	kg	26	26	26
Sound Pressure Level (H / M / L)		dB(A)	42 / 39 / 36	44 / 41 / 39	46 / 43 / 41
Sound Power Level (H / M / L)		dB(A)	54 / 51 / 47	56 / 53 / 49	58 / 54 / 53
Power Supply		Ø, V, Hz	1, 220-240, 50	1, 220-240, 50	1, 220-240, 50
Communication Cable (VCTF-SB)		mm ² x cores	1.0 - 1.5 x 2	1.0 - 1.5 x 2	1.0 - 1.5 x 2
	Model Name		PT-AAGW0 PT-AFGW0	PT-AAGW0 PT-AFGW0	PT-AAGW0 PT-AFGW0
Decoration Panel (Accessory)	Exterior Color		White	White	White
	RAL Code		RAL 9003	RAL 9003	RAL 9003
	Net Dimensions (W x H x D)	mm	950 x 35 x 950	950 x 35 x 950	950 x 35 x 950
	Net Weight	kg	7.1 / 7.5 / 8.5	7.1 / 7.5 / 8.5	7.1 / 7.5 / 8.5

Note :
 1. Performance tested under EN14511
 2. Capacities are based on the following conditions
 - Cooling : Indoor temp. 27°C (80.6°F) DB / 19°C (66.2°F) WB, Outdoor temp. 35°C (95°F) DB / 24°C (75.2°F) WB, Interconnecting piping length 7.5m, Level difference of zero
 - Heating : Indoor temp. 20°C (68°F) DB / 15°C (59°F) WB, Outdoor temp. 7°C (44.6°F) DB / 6°C (42.8°F) WB, Interconnecting piping length 7.5m, Level difference of zero
 3. Due to our policy of innovation, some specifications may be changed without notification

Accessories

CHASSIS	ARNU36GTAB4	ARNU42GTAB4	ARNU48GTAB4
Drain Pump		○	
Cassette Cover		PTDCM	
Refrigerant Leakage Detector		PRLDNVSO	
EEV Kit		-	
Independent Power Module		PRIP0	
Robot Cleaner		-	
Pre Filter (Washable)		○	
Ion Generator		-	
CO ₂ Sensor		-	
Ventilation Kit		-	
IR Receiver		-	
Zone Controller		-	
Dry Contact (with additional accessory)		PDRYCB000 (1 point contact), PDRYCB320 (Universal input), PDRYCB400 (2 points input), PDRYCB500 (Modbus)	
External Input (1 Point)		○	
Wi-Fi		PWFMD200	
Human detection sensor		PTVSA00	
Floor Temperature Sensor		PT-AFGW0 :○	
Air cleaning kit		PT-AFGW0 : PTAFMPO	
Elevation Grille		PT-AEGW0 :○	

High sensible

ARNU07GTAA4 / ARNU09GTAA4 / ARNU12GTAA4
ARNU15GTAA4 / ARNU18GTAA4



MODEL		UNIT	ARNU07GTAA4	ARNU09GTAA4	ARNU12GTAA4	ARNU15GTAA4	ARNU18GTAA4
Cooling Capacity		kW	2.2	2.8	3.6	4.5	5.6
Heating Capacity		kW	2.5	3.2	4.0	5.0	6.3
Power Input (H / M / L)	Nominal	W	23 / 16 / 11	25 / 18 / 11	26 / 19 / 13	29 / 20 / 15	31 / 23 / 16
	Body	mm	840 x 288 x 840	840 x 288 x 840	840 x 288 x 840	840 x 288 x 840	840 x 288 x 840
Dimensions (W x H x D)	Shipping	mm	922 x 360 x 917	922 x 360 x 917	922 x 360 x 917	922 x 360 x 917	922 x 360 x 917
	Type		Full 3D Turbo Fan	Full 3D Turbo Fan	Full 3D Turbo Fan	Full 3D Turbo Fan	Full 3D Turbo Fan
Fan	Motor Output x Number	W	166 x 1	166 x 1	166 x 1	166 x 1	166 x 1
	Running Current	A	0.23	0.25	0.25	0.27	0.28
	Air Flow Rate (H / M / L)	m³/min	19 / 16 / 13	19 / 16 / 13	20 / 17 / 15	20 / 17 / 15	21 / 19 / 16
	Motor Type		BLDC	BLDC	BLDC	BLDC	BLDC
	Air Filter		Pre Filter	Pre Filter	Pre Filter	Pre Filter	Pre Filter
Pipe Connections	Liquid Side	mm (inch)	Ø9.52 (3/8)	Ø9.52 (3/8)	Ø9.52 (3/8)	Ø9.52 (3/8)	Ø9.52 (3/8)
	Gas Side	mm (inch)	Ø15.88 (5/8)	Ø15.88 (5/8)	Ø15.88 (5/8)	Ø15.88 (5/8)	Ø15.88 (5/8)
	Drain Pipe (Internal Dia.)	mm (inch)	Ø25 (1)	Ø25 (1)	Ø25 (1)	Ø25 (1)	Ø25 (1)
Weight	Body	kg	26	26	26	26	26
Sound Pressure Level (H / M / L)		dB(A)	32 / 30 / 26	33 / 30 / 26	34 / 31 / 27	34 / 32 / 29	35 / 32 / 30
Sound Power Level (H / M / L)		dB(A)	41 / 38 / 34	42 / 39 / 34	42 / 40 / 36	43 / 40 / 37	44 / 41 / 38
Power Supply		Ø, V, Hz	1, 220-240, 50	1, 220-240, 50	1, 220-240, 50	1, 220-240, 50	1, 220-240, 50
Communication Cable (VCTF-SB)		mm² x cores	1.0 - 1.5 x 2	1.0 - 1.5 x 2	1.0 - 1.5 x 2	1.0 - 1.5 x 2	1.0 - 1.5 x 2
Decoration Panel (Accessory)	Model Name		PT-AAGW0 PT-AFGW0	PT-AAGW0 PT-AFGW0	PT-AAGW0 PT-AFGW0	PT-AAGW0 PT-AFGW0	PT-AAGW0 PT-AFGW0
	Exterior Color		White	White	White	White	White
	RAL Code		RAL 9003	RAL 9003	RAL 9003	RAL 9003	RAL 9003
	Net Dimensions (W x H x D)	mm	950 x 35 x 950	950 x 35 x 950	950 x 35 x 950	950 x 35 x 950	950 x 35 x 950
	Net Weight	kg	7.1 / 7.5 / 8.5	7.1 / 7.5 / 8.5	7.1 / 7.5 / 8.5	7.1 / 7.5 / 8.5	7.1 / 7.5 / 8.5

Note:
1. Performance tested under EN14511
2. Capacities are based on the following conditions
- Cooling : Indoor temp. 27°C (80.6°F) DB / 19°C (66.2°F) WB, Outdoor temp. 35°C (95°F) DB / 24°C (75.2°F) WB, Interconnecting piping length 7.5m, Level difference of zero
- Heating : Indoor temp. 20°C (68°F) DB / 15°C (59°F) WB, Outdoor temp. 7°C (44.6°F) DB / 6°C (42.8°F) WB, Interconnecting piping length 7.5m, Level difference of zero
3. Due to our policy of innovation, some specifications may be changed without notification

Accessories

CHASSIS	ARNU07GTAA4	ARNU09GTAA4	ARNU12GTAA4	ARNU15GTAA4	ARNU18GTAA4
Drain Pump			○		
Cassette Cover			PTDCM		
Refrigerant Leakage Detector			PRLDNVSO		
EEV Kit			-		
Independent Power Module			PRIP0		
Robot Cleaner			-		
Pre Filter (Washable)			○		
Ion Generator			-		
CO ₂ Sensor			-		
Ventilation Kit			-		
IR Receiver			-		
Zone Controller			-		
Dry Contact (with additional accessory)		PDRYCB000 (1 point contact), PDRYCB320 (Universal input), PDRYCB400 (2 points input), PDRYCB500 (Modbus)			
External Input (1 Point)			○		
Wi-Fi			PWFMD200		
Human detection sensor			PTVSA00		
Floor Temperature Sensor			PT-AFGW0 : ○		
Air cleaning kit			PT-AFGW0 : PTAFMPO		
Elevation Grille			PT-AEGW0 : ○		

High sensible

ARNU24GTAA4 / ARNU28GTAA4 / ARNU36GTAA4
ARNU42GTAA4 / ARNU48GTAA4



MODEL		UNIT	ARNU24GTAA4	ARNU28GTAA4	ARNU36GTAA4	ARNU42GTAA4	ARNU48GTAA4
Cooling Capacity		kW	7.1	8.2	10.6	12.3	14.1
Heating Capacity		kW	8.0	9.2	11.9	13.8	15.9
Power Input (H / M / L)	Nominal	W	35 / 29 / 20	40 / 31 / 25	65 / 43 / 31	86 / 65 / 43	100 / 67 / 53
	Body	mm	840 x 288 x 840	840 x 288 x 840	840 x 288 x 840	840 x 288 x 840	840 x 288 x 840
Dimensions (W x H x D)	Shipping	mm	922 x 360 x 917	922 x 360 x 917	922 x 360 x 917	922 x 360 x 917	922 x 360 x 917
	Type		Full 3D Turbo Fan	Full 3D Turbo Fan	Full 3D Turbo Fan	Full 3D Turbo Fan	Full 3D Turbo Fan
Fan	Motor Output x Number	W	166 x 1	166 x 1	166 x 1	166 x 1	166 x 1
	Running Current	A	0.38	0.46	0.60	0.80	0.88
	Air Flow Rate (H / M / L)	m³/min	23 / 21 / 19	24 / 22 / 20	28 / 24 / 21	31 / 28 / 24	33 / 28 / 26
	Motor Type		BLDC	BLDC	BLDC	BLDC	BLDC
	Air Filter		Pre Filter	Pre Filter	Pre Filter	Pre Filter	Pre Filter
Pipe Connections	Liquid Side	mm (inch)	Ø9.52 (3/8)	Ø9.52 (3/8)	Ø9.52 (3/8)	Ø9.52 (3/8)	Ø9.52 (3/8)
	Gas Side	mm (inch)	Ø15.88 (5/8)	Ø15.88 (5/8)	Ø15.88 (5/8)	Ø15.88 (5/8)	Ø15.88 (5/8)
	Drain Pipe (Internal Dia.)	mm (inch)	Ø25 (1)	Ø25 (1)	Ø25 (1)	Ø25 (1)	Ø25 (1)
Weight	Body	kg	26	26	26	26	26
Sound Pressure Level (H / M / L)		dB(A)	39 / 36 / 33	40 / 37 / 34	42 / 39 / 35	46 / 42 / 39	47 / 43 / 41
Sound Power Level (H / M / L)		dB(A)	47 / 45 / 42	48 / 46 / 42	51 / 48 / 44	54 / 51 / 48	56 / 52 / 50
Power Supply		Ø, V, Hz	1, 220-240, 50	1, 220-240, 50	1, 220-240, 50	1, 220-240, 50	1, 220-240, 50
Communication Cable (VCTF-SB)		mm² x cores	1.0 - 1.5 x 2	1.0 - 1.5 x 2	1.0 - 1.5 x 2	1.0 - 1.5 x 2	1.0 - 1.5 x 2
Decoration Panel (Accessory)	Model Name		PT-AAGW0 PT-AFGW0	PT-AAGW0 PT-AFGW0	PT-AAGW0 PT-AFGW0	PT-AAGW0 PT-AFGW0	PT-AAGW0 PT-AFGW0
	Exterior Color		White	White	White	White	White
	RAL Code		RAL 9003	RAL 9003	RAL 9003	RAL 9003	RAL 9003
	Net Dimensions (W x H x D)	mm	950 x 35 x 950	950 x 35 x 950	950 x 35 x 950	950 x 35 x 950	950 x 35 x 950
	Net Weight	kg	7.1 / 7.5 / 8.5	7.1 / 7.5 / 8.5	7.1 / 7.5 / 8.5	7.1 / 7.5 / 8.5	7.1 / 7.5 / 8.5

Note:
1. Performance tested under EN14511
2. Capacities are based on the following conditions
- Cooling : Indoor temp. 27°C (80.6°F) DB / 19°C (66.2°F) WB, Outdoor temp. 35°C (95°F) DB / 24°C (75.2°F) WB, Interconnecting piping length 7.5m, Level difference of zero
- Heating : Indoor temp. 20°C (68°F) DB / 15°C (59°F) WB, Outdoor temp. 7°C (44.6°F) DB / 6°C (42.8°F) WB, Interconnecting piping length 7.5m, Level difference of zero
3. Due to our policy of innovation, some specifications may be changed without notification

Accessories

CHASSIS	ARNU24GTAA4	ARNU28GTAA4	ARNU36GTAA4	ARNU42GTAA4	ARNU48GTAA4
Drain Pump			○		
Cassette Cover			PTDCM		
Refrigerant Leakage Detector			PRLDNVSO		
EEV Kit			-		
Independent Power Module			PRIP0		
Robot Cleaner			-		
Pre Filter (Washable)			○		
Ion Generator			-		
CO ₂ Sensor			-		
Ventilation Kit			-		
IR Receiver			-		
Zone Controller			-		
Dry Contact (with additional accessory)		PDRYCB000 (1 point contact), PDRYCB320 (Universal input), PDRYCB400 (2 points input), PDRYCB500 (Modbus)			
External Input (1 Point)			○		
Wi-Fi			PWFMD200		
Human detection sensor			PTVSA00		
Floor Temperature Sensor			PT-AFGW0 : ○		
Air cleaning kit			PT-AFGW0 : PTAFMPO		
Elevation Grille			PT-AEGW0 : ○		

**ARNU05GTRB4 / ARNU07GTRB4
ARNU09GTRB4 / ARNU12GTRB4**



MODEL		UNIT	ARNU05GTRB4	ARNU07GTRB4	ARNU09GTRB4	ARNU12GTRB4
Cooling Capacity		kW	1.6	2.2	2.8	3.6
Heating Capacity		kW	1.8	2.5	3.2	4.0
Power Input (H / M / L)	Nominal	W	13 / 12 / 11	13 / 12 / 11	14 / 13 / 12	17 / 15 / 13
	Body	mm	570 x 214 x 570	570 x 214 x 570	570 x 214 x 570	570 x 214 x 570
Dimensions (W x H x D)	Shipping	mm	667 x 285 x 646	667 x 285 x 646	667 x 285 x 646	667 x 285 x 646
	Type		Turbo Fan	Turbo Fan	Turbo Fan	Turbo Fan
Fan	Motor Output x Number	W	43 x 1	43 x 1	43 x 1	43 x 1
	Air Flow Rate (H / M / L)	m³/min	7.5 / 7.0 / 6.6	7.5 / 7.0 / 6.6	8.0 / 7.5 / 7.1	8.7 / 8.0 / 7.0
	Motor Type		BLDC	BLDC	BLDC	BLDC
Air Filter			Pre Filter	Pre Filter	Pre Filter	Pre Filter
Pipe Connections	Liquid Side	mm (inch)	Ø6.35 (1/4)	Ø6.35 (1/4)	Ø6.35 (1/4)	Ø6.35 (1/4)
	Gas Side	mm (inch)	Ø12.7 (1/2)	Ø12.7 (1/2)	Ø12.7 (1/2)	Ø12.7 (1/2)
	Drain Pipe (Internal Dia.)	mm (inch)	Ø25 (1)	Ø25 (1)	Ø25 (1)	Ø25 (1)
Weight	Body	kg	12.6	12.6	13.7	13.7
Sound Pressure Levels (H / M / L)		dB(A)	29 / 27 / 26	29 / 27 / 26	30 / 29 / 27	32 / 30 / 27
Sound Power Levels (H / M / L)		dB(A)	45 / 43 / 42	45 / 43 / 42	46 / 43 / 42	48 / 46 / 43
Power Supply		Ø, V, Hz	1, 220-240, 50	1, 220-240, 50	1, 220-240, 50	1, 220-240, 50
Transmission Cable		mm²	1.0 - 1.5 x 2C	1.0 - 1.5 x 2C	1.0 - 1.5 x 2C	1.0 - 1.5 x 2C
Decoration Panel (Accessory)	Model Name		PT-UQC PT-QCHW0 PT-QAGW0	PT-UQC PT-QCHW0 PT-QAGW0	PT-UQC PT-QCHW0 PT-QAGW0	PT-UQC PT-QCHW0 PT-QAGW0
	Exterior Color		Morning Fog	Morning Fog	Morning Fog	Morning Fog
	RAL Code		RAL 9001	RAL 9001	RAL 9001	RAL 9001
	Net Dimensions (W x H x D)	mm	700 x 22 x 700 620 x 20 x 620	700 x 22 x 700 620 x 20 x 620	700 x 22 x 700 620 x 20 x 620	700 x 22 x 700 620 x 20 x 620
	Net Weight	kg	3.0 / 3.0	3.0 / 3.0	3.0 / 3.0	3.0 / 3.0

Note:
 1. Performance tested under EN14511
 2. Capacities are based on the following conditions
 - Cooling : Indoor temp. 27°C (80.6°F) DB / 19°C (66.2°F) WB, Outdoor temp. 35°C (95°F) DB / 24°C (75.2°F) WB, Interconnecting piping length 7.5m, Level difference of zero
 - Heating : Indoor temp. 20°C (68°F) DB / 15°C (59°F) WB, Outdoor temp. 7°C (44.6°F) DB / 6°C (42.8°F) WB, Interconnecting piping length 7.5m, Level difference of zero
 3. Due to our policy of innovation, some specifications may be changed without notification

Accessories

CHASSIS	ARNU05GTRB4	ARNU07GTRB4	ARNU09GTRB4	ARNU12GTRB4
Drain Pump			○	
Cassette Cover			PTDCQ	
Refrigerant Leakage Detector			PRLDNVSO	
EEV Kit			PRGK024A0 (-4.5kW)	
Independent Power Module			PRIPO	
Robot Cleaner			-	
Pre Filter (Washable)			○	
Ion Generator			-	
CO ₂ Sensor			-	
Ventilation Kit			PTVK430	
IR Receiver			-	
Zone Controller			-	
Dry Contact (with additional accessory)			PDRYCB000 (1 point contact), PDRYCB320 (Universal input), PDRYCB400 (2 points input), PDRYCB500 (Modbus)	
External Input (1 point)			○	
Wi-Fi			PWFMD200	

※ ○ : Applied, - : Not applied
 Option : Refer to model name in table

**ARNU15GTQB4 / ARNU18GTQB4
ARNU21GTQB4**



MODEL		UNIT	ARNU15GTQB4	ARNU18GTQB4	ARNU21GTQB4
Cooling Capacity		kW	4.5	5.6	6.0
Heating Capacity		kW	5.0	6.3	6.8
Power Input (H / M / L)	Nominal	W	24 / 21 / 18	25 / 22 / 19	28 / 23 / 20
	Body	mm	570 x 256 x 570	570 x 256 x 570	570 x 256 x 570
Dimensions (W x H x D)	Shipping	mm	667 x 327 x 646	667 x 327 x 646	667 x 327 x 646
	Type		Turbo Fan	Turbo Fan	Turbo Fan
Fan	Motor Output x Number	W	43 x 1	43 x 1	43 x 1
	Air Flow Rate (H / M / L)	m³/min	11.0 / 10.0 / 9.3	11.2 / 11.0 / 10.0	12.0 / 11.1 / 9.4
	Motor Type		BLDC	BLDC	BLDC
Air Filter			Pre Filter	Pre Filter	Pre Filter
Pipe Connections	Liquid Side	mm (inch)	Ø6.35 (1/4)	Ø6.35 (1/4)	Ø9.52 (3/8)
	Gas Side	mm (inch)	Ø12.7 (1/2)	Ø12.7 (1/2)	Ø15.88 (5/8)
	Drain Pipe (Internal Dia.)	mm (inch)	Ø25 (1)	Ø25 (1)	Ø25 (1)
Weight	Body	kg	15.0	15.0	15.0
Sound Pressure Levels (H / M / L)		dB(A)	36 / 34 / 32	37 / 35 / 34	40 / 38 / 34
Sound Power Levels (H / M / L)		dB(A)	50 / 48 / 46	51 / 50 / 46	53 / 51 / 46
Power Supply		Ø, V, Hz	1, 220-240, 50	1, 220-240, 50	1, 220-240, 50
Transmission Cable		mm²	1.0 - 1.5 x 2C	1.0 - 1.5 x 2C	1.0 - 1.5 x 2C
Decoration Panel (Accessory)	Model Name		PT-UQC PT-QCHW0 PT-QAGW0	PT-UQC PT-QCHW0 PT-QAGW0	PT-UQC PT-QCHW0 PT-QAGW0
	Exterior Color		Morning Fog	Morning Fog	Morning Fog
	RAL Code		RAL 9001	RAL 9001	RAL 9001
	Net Dimensions (W x H x D)	mm	700 x 22 x 700 620 x 20 x 620	700 x 22 x 700 620 x 20 x 620	700 x 22 x 700 620 x 20 x 620
	Net Weight	kg	3.0 / 3.0	3.0 / 3.0	3.0 / 3.0

Note:
 1. Performance tested under EN14511
 2. Capacities are based on the following conditions
 - Cooling : Indoor temp. 27°C (80.6°F) DB / 19°C (66.2°F) WB, Outdoor temp. 35°C (95°F) DB / 24°C (75.2°F) WB, Interconnecting piping length 7.5m, Level difference of zero
 - Heating : Indoor temp. 20°C (68°F) DB / 15°C (59°F) WB, Outdoor temp. 7°C (44.6°F) DB / 6°C (42.8°F) WB, Interconnecting piping length 7.5m, Level difference of zero
 3. Due to our policy of innovation, some specifications may be changed without notification

Accessories

CHASSIS	ARNU15GTQB4	ARNU18GTQB4	ARNU21GTQB4
Drain Pump			○
Cassette Cover			PTDCQ
Refrigerant Leakage Detector			PRLDNVSO
EEV Kit			PRGK024A0 (-4.5kW)
Independent Power Module			PRIPO
Robot Cleaner			-
Pre Filter (Washable)			○
Ion Generator			-
CO ₂ Sensor			-
Ventilation Kit			PTVK430
IR Receiver			-
Zone Controller			-
Dry Contact (with additional accessory)			PDRYCB000 (1 point contact), PDRYCB320 (Universal input), PDRYCB400 (2 points input), PDRYCB500 (Modbus)
External Input (1 point)			○
Wi-Fi			PWFMD200

※ ○ : Applied, - : Not applied
 Option : Refer to model name in table

ARNU09GTSC4 / ARNU12GTSC4



MODEL		UNIT	ARNU09GTSC4	ARNU12GTSC4
Cooling Capacity		kW	2.8	3.6
Heating Capacity		kW	3.2	4.0
Power Input (H / M / L)	Nominal	W	16 / 14 / 11	18 / 14 / 11
Dimensions (W x H x D)	Body	mm	830 x 225 x 600	830 x 225 x 600
	Shipping	mm	1,055 x 290 x 682	1,055 x 290 x 682
Fan	Type		Turbo Fan	Turbo Fan
	Motor Output x Number	W x No.	37 x 1	37 x 1
	Air Flow Rate (H / M / L)	m³/min	10.8 / 9.8 / 9.1	11.1 / 10.3 / 9.1
	Motor Type		BLDC	BLDC
Air Filter			Pre Filter	Pre Filter
Pipe Connections	Liquid Side	mm (inch)	Ø6.35 (1/4)	Ø6.35 (1/4)
	Gas Side	mm (inch)	Ø12.7 (1/2)	Ø12.7 (1/2)
	Drain Pipe (Internal Dia.)	mm (inch)	Ø25 (1)	Ø25 (1)
Weight	Body	kg	18.1	18.1
Sound Pressure Levels (H / M / L)		dB(A)	33 / 31 / 29	34 / 32 / 29
Sound Power Levels (H / M / L)		dB(A)	42 / 40 / 38	43 / 41 / 39
Power Supply		Ø, V, Hz	1, 220-240, 50	1, 220-240, 50
Communication Cable		mm²	1.0 - 1.5 x 2C	1.0 - 1.5 x 2C
Decoration Panel (Accessory)	Model Name		PT-USC	PT-USC
	Exterior Color		Morning Fog	Morning Fog
	RAL Code		RAL 9001	RAL 9001
	Net Dimensions (W x H x D)	mm	1,100 x 28 x 690	1,100 x 28 x 690
	Net Weight	kg	4.7	4.7

Note :
 1. Performance tested under EN14511
 2. Capacities are based on the following conditions
 - Cooling : Indoor temp. 27°C (80.6°F) DB / 19°C (66.2°F) WB, Outdoor temp. 35°C (95°F) DB / 24°C (75.2°F) WB, Interconnecting piping length 7.5m, Level difference of zero
 - Heating : Indoor temp. 20°C (68°F) DB / 15°C (59°F) WB, Outdoor temp. 7°C (44.6°F) DB / 6°C (42.8°F) WB, Interconnecting piping length 7.5m, Level difference of zero
 3. Due to our policy of innovation, some specifications may be changed without notification

Accessories

CHASSIS	ARNU09GTSC4	ARNU12GTSC4
Drain Pump		○
Cassette Cover		-
Refrigerant Leakage Detector		PRLDNVSO
EEV Kit		PRGK024A0 (-5.6kW)
Independent Power Module		PRIPO
Robot Cleaner		-
Pre Filter (Washable)		○
Ion Generator		-
CO2 Sensor		-
Ventilation Kit		-
IR Receiver		-
Zone Controller		-
Dry Contact (with additional accessory)		PDRYCB000 (1 point contact), PDRYCB320 (Universal input), PDRYCB400 (2 points input), PDRYCB500 (Modbus)
External Input (1 point)		○
Wi-Fi		PWFMD200

※ ○ : Applied, - : Not applied
 Option : Refer to model name in table

ARNU18GTSC4 / ARNU24GTSC4



MODEL		UNIT	ARNU18GTSC4	ARNU24GTSC4
Cooling Capacity		kW	5.6	7.1
Heating Capacity		kW	6.3	8.0
Power Input (H / M / L)	Nominal	W	19 / 16 / 14	31 / 22 / 14
Dimensions (W x H x D)	Body	mm	830 x 225 x 600	830 x 225 x 600
	Shipping	mm	1,055 x 290 x 682	1,055 x 290 x 682
Fan	Type		Turbo Fan	Turbo Fan
	Motor Output x Number	W x No.	37 x 1	37 x 1
	Air Flow Rate (H / M / L)	m³/min	11.8 / 10.8 / 9.8	14.5 / 12.4 / 10.3
	Motor Type		BLDC	BLDC
Air Filter			Pre Filter	Pre Filter
Pipe Connections	Liquid Side	mm (inch)	Ø6.35 (1/4)	Ø9.52 (3/8)
	Gas Side	mm (inch)	Ø12.7 (1/2)	Ø15.88 (5/8)
	Drain Pipe (Internal Dia.)	mm (inch)	Ø25 (1)	Ø25 (1)
Weight	Body	kg	18.1	18.1
Sound Pressure Levels (H / M / L)		dB(A)	35 / 33 / 31	40 / 37 / 33
Sound Power Levels (H / M / L)		dB(A)	44 / 42 / 40	48 / 45 / 40
Power Supply		Ø, V, Hz	1, 220-240, 50	1, 220-240, 50
Communication Cable		mm²	1.0 - 1.5 x 2C	1.0 - 1.5 x 2C
Decoration Panel (Accessory)	Model Name		PT-USC	PT-USC
	Exterior Color		Morning Fog	Morning Fog
	RAL Code		RAL 9001	RAL 9001
	Net Dimensions (W x H x D)	mm	1,100 x 28 x 690	1,100 x 28 x 690
	Net Weight	kg	4.7	4.7

Note :
 1. Performance tested under EN14511
 2. Capacities are based on the following conditions
 - Cooling : Indoor temp. 27°C (80.6°F) DB / 19°C (66.2°F) WB, Outdoor temp. 35°C (95°F) DB / 24°C (75.2°F) WB, Interconnecting piping length 7.5m, Level difference of zero
 - Heating : Indoor temp. 20°C (68°F) DB / 15°C (59°F) WB, Outdoor temp. 7°C (44.6°F) DB / 6°C (42.8°F) WB, Interconnecting piping length 7.5m, Level difference of zero
 3. Due to our policy of innovation, some specifications may be changed without notification

Accessories

Chassis	ARNU18GTSC4	ARNU24GTSC4
Drain Pump		○
Cassette Cover		-
Refrigerant Leakage Detector		PRLDNVSO
EEV Kit		PRGK024A0 (-5.6kW)
Independent Power Module		PRIPO
Robot Cleaner		-
Pre Filter (Washable)		○
Ion Generator		-
CO2 Sensor		-
Ventilation Kit		-
IR Receiver		-
Zone Controller		-
Dry Contact (with additional accessory)		PDRYCB000 (1 point contact), PDRYCB320 (Universal input), PDRYCB400 (2 points input), PDRYCB500 (Modbus)
External Input (1 point)		○
Wi-Fi		PWFMD200

※ ○ : Applied, - : Not applied
 Option : Refer to model name in table

ARNU07GTUB4 / ARNU09GTUB4
ARNU12GTUB4



MODEL		UNIT	ARNU07GTUB4	ARNU09GTUB4	ARNU12GTUB4
Cooling Capacity		kW	2.2	2.8	3.6
Heating Capacity		kW	2.5	3.2	4.0
Power Input (H / M / L)	Nominal	W	20 / 18 / 16	22 / 20 / 18	24 / 22 / 20
Dimensions (W x H x D)	Body	mm	860 x 132 x 450	860 x 132 x 450	860 x 132 x 450
	Shipping	mm	1,129 x 259 x 538	1,129 x 259 x 538	1,129 x 259 x 538
Fan	Type		Cross Flow Fan	Cross Flow Fan	Cross Flow Fan
	Motor Output x Number	W x No.	30 x 1	30 x 1	30 x 1
	Air Flow Rate (H / M / L)	m³/min	8.2 / 7.3 / 6.4	9.2 / 8.6 / 8.2	10.0 / 9.2 / 8.2
	Motor Type		BLDC	BLDC	BLDC
Air Filter			Pre Filter	Pre Filter	Pre Filter
Pipe Connections	Liquid Side	mm (inch)	Ø6.35 (1/4)	Ø6.35 (1/4)	Ø6.35 (1/4)
	Gas Side	mm (inch)	Ø12.7 (1/2)	Ø12.7 (1/2)	Ø12.7 (1/2)
	Drain Pipe (Internal Dia.)	mm (inch)	Ø25 (1)	Ø25 (1)	Ø25 (1)
Weight	Body	kg	12.2	12.2	12.2
Sound Pressure Levels (H / M / L)		dB(A)	32 / 29 / 25	35 / 34 / 32	38 / 35 / 32
Sound Power Levels (H / M / L)		dB(A)	47 / 44 / 41	50 / 48 / 47	52 / 50 / 47
Power Supply		Ø, V, Hz	1, 220-240, 50	1, 220-240, 50	1, 220-240, 50
Transmission Cable		mm²	1.0 - 1.5 x 2C	1.0 - 1.5 x 2C	1.0 - 1.5 x 2C
Decoration Panel (Accessory)	Model Name		PT-UAHG0, PT-UAHW0, PT-UPHG0	PT-UAHG0, PT-UAHW0, PT-UPHG0	PT-UAHG0, PT-UAHW0, PT-UPHG0
	Exterior Color		Noble White	Noble White	Noble White
	RAL Code		RAL 9003	RAL 9003	RAL 9003
	Net Dimensions (W x H x D)	mm	1,420 x 34 x 500	1,420 x 34 x 500	1,420 x 34 x 500
	Net Weight	kg	5.5 / 6.5	5.5 / 6.5	5.5 / 6.5

Note :
 1. Performance tested under EN14511
 2. Capacities are based on the following conditions
 - Cooling : Indoor temp. 27°C (80.6°F) DB / 19°C (66.2°F) WB, Outdoor temp. 35°C (95°F) DB / 24°C (75.2°F) WB, Interconnecting piping length 7.5m, Level difference of zero
 - Heating : Indoor temp. 20°C (68°F) DB / 15°C (59°F) WB, Outdoor temp. 7°C (44.6°F) DB / 6°C (42.8°F) WB, Interconnecting piping length 7.5m, Level difference of zero
 3. Due to our policy of innovation, some specifications may be changed without notification

Accessories

CHASSIS	ARNU07GTUB4	ARNU09GTUB4	ARNU12GTUB4
Drain Pump		○	
Cassette Cover		-	
Refrigerant Leakage Detector		PRLDNVSO	
EEV Kit		PRGK024A0	
Independent Power Module		PRIPO	
Robot Cleaner		-	
Pre Filter (Washable)		○	
Ion Generator		-	
CO2 Sensor		-	
Ventilation Kit		-	
IR Receiver		-	
Zone Controller		-	
Dry Contact (with additional accessory)		PDRYCB000 (1 point contact), PDRYCB320 (Universal input), PDRYCB400 (2 points input), PDRYCB500 (Modbus)	
External Input (1 point)		○	
Air Cleaning Kit		PTAHTPO	
Wi-Fi		PWFMD200	

※ ○ : Applied, - : Not applied
 Option : Refer to model name in table

ARNU18GTTB4 / ARNU24GTTB4



MODEL		UNIT	ARNU18GTTB4	ARNU24GTTB4
Cooling Capacity		kW	5.6	7.1
Heating Capacity		kW	6.3	7.1
Power Input (H / M / L)	Nominal	W	38 / 28 / 24	51 / 33 / 26
Dimensions (W x H x D)	Body	mm	1,180 x 132 x 450	1,180 x 132 x 450
	Shipping	mm	1,499 x 259 x 538	1,499 x 259 x 538
Fan	Type		Cross Flow Fan	Cross Flow Fan
	Motor Output x Number	W x No.	30 x 1	30 x 1
	Air Flow Rate (H / M / L)	m³/min	13.3 / 12.1 / 10.9	14.6 / 13.3 / 11.5
	Motor Type		BLDC	BLDC
Air Filter			Pre Filter	Pre Filter
Pipe Connections	Liquid Side	mm (inch)	Ø6.35 (1/4)	Ø9.52 (3/8)
	Gas Side	mm (inch)	Ø12.7 (1/2)	Ø15.88 (5/8)
	Drain Pipe (Internal Dia.)	mm (inch)	Ø25 (1)	Ø25 (1)
Weight	Body	kg	15.6	15.6
Sound Pressure Levels (H / M / L)		dB(A)	40 / 37 / 35	43 / 40 / 36
Sound Power Levels (H / M / L)		dB(A)	56 / 51 / 48	59 / 53 / 50
Power Supply		Ø, V, Hz	1, 220-240, 50	1, 220-240, 50
Transmission Cable		mm²	1.0 - 1.5 x 2C	1.0 - 1.5 x 2C
Decoration Panel (Accessory)	Model Name		PT-TAHG0, PT-TAHW0, PT-TPHG0	PT-TAHG0, PT-TAHW0, PT-TPHG0
	Exterior Color		Noble White	Noble White
	RAL Code		RAL 9003	RAL 9003
	Net Dimensions (W x H x D)	mm	1,100 x 34 x 500	1,100 x 34 x 500
	Net Weight	kg	4.6 / 5.3	4.6 / 5.3

Note :
 1. Performance tested under EN14511
 2. Capacities are based on the following conditions
 - Cooling : Indoor temp. 27°C (80.6°F) DB / 19°C (66.2°F) WB, Outdoor temp. 35°C (95°F) DB / 24°C (75.2°F) WB, Interconnecting piping length 7.5m, Level difference of zero
 - Heating : Indoor temp. 20°C (68°F) DB / 15°C (59°F) WB, Outdoor temp. 7°C (44.6°F) DB / 6°C (42.8°F) WB, Interconnecting piping length 7.5m, Level difference of zero
 3. Due to our policy of innovation, some specifications may be changed without notification

Accessories

CHASSIS	ARNU18GTTB4	ARNU24GTTB4
Drain Pump		○
Cassette Cover		-
Refrigerant Leakage Detector		PRLDNVSO
EEV Kit		-
Independent Power Module		PRIPO
Robot Cleaner		-
Pre Filter (Washable)		○
Ion Generator		-
CO2 Sensor		-
Ventilation Kit		-
IR Receiver		-
Zone Controller		-
Dry Contact (with additional accessory)		PDRYCB000 (1 point contact), PDRYCB320 (Universal input), PDRYCB400 (2 points input), PDRYCB500 (Modbus)
External Input (1 point)		○
Air Cleaning Kit		PTAHTPO
Wi-Fi		PWFMD200

※ ○ : Applied, - : Not applied
 Option : Refer to model name in table



Features & Benefits

- Luxury round design can make a luxurious space with a round design considering side view.
- Perfect round air flow without blind spots.

Key Applications

- Retail
- Office
- Restaurant
- Hotel

	CASSETTE	ROUND
Smart	Wi-Fi	○
Energy Efficiency	Human Detect Sensor	-
Comfort	Drain Pump	○
	Sleep Mode	○
	Timer (On / Off)	○
	Timer (Weekly)	○
	Two Thermistor Control	○
	Group Control	○

※ ○: Applied, -: Not applied

Slim and Compact Design

Reduce the height of the body by 15%, save space and maximize the openness of the interior space.

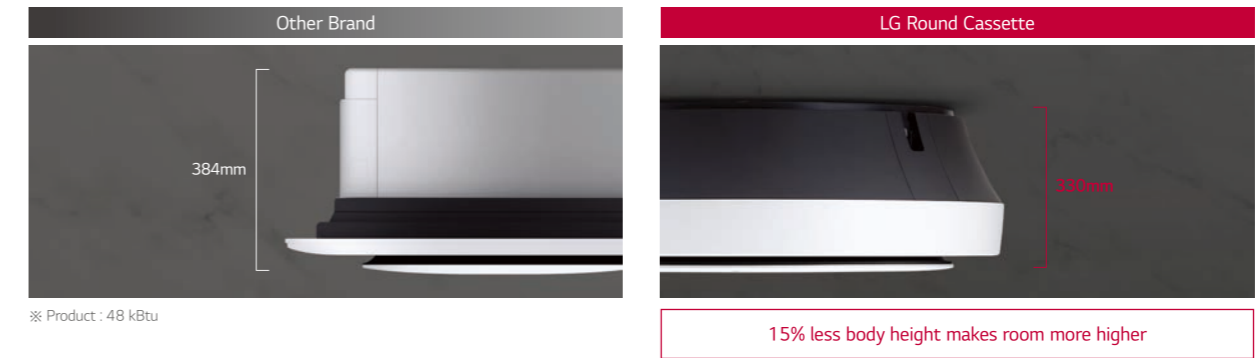

Minimal Exposure Design

Pipes are brought together in one place to minimize exposure. Hanger covers hide installations to add a clean look.

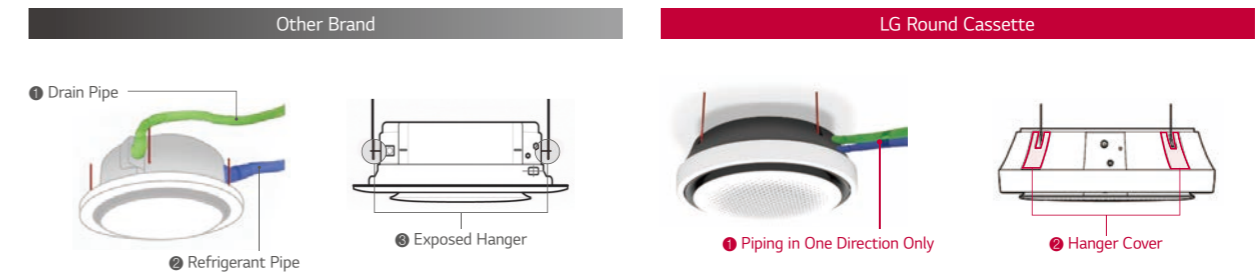

Perfect Round Air Flow

Perfect round flow without blind spots.

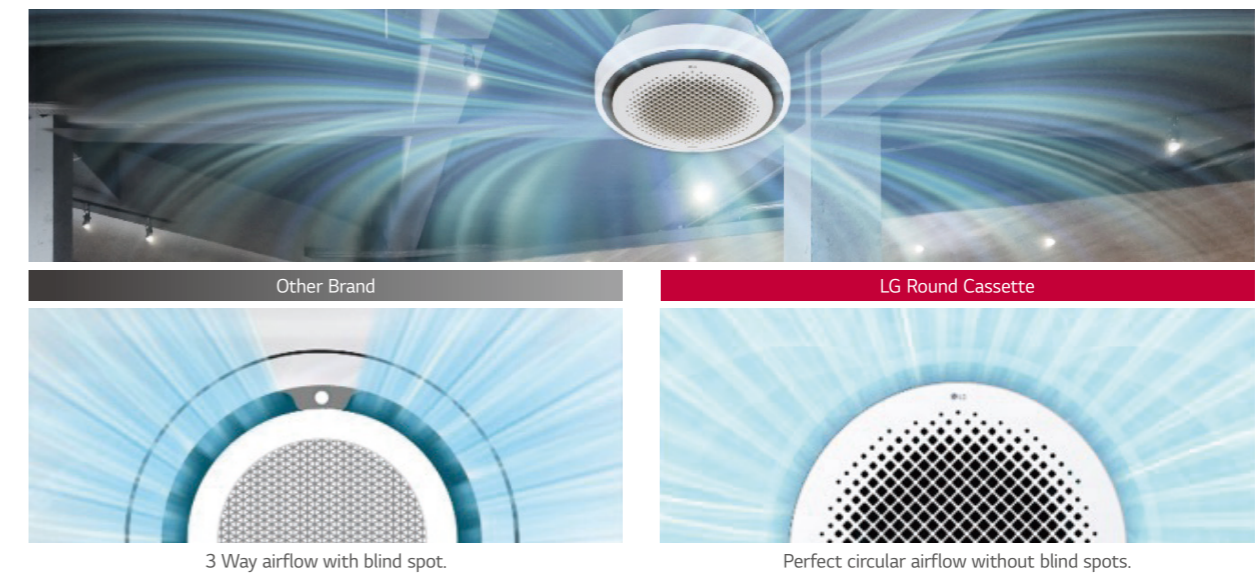

Visible Air Flow

With crystal vein for 6-step precision control, you can send cool / heated air wherever you want.

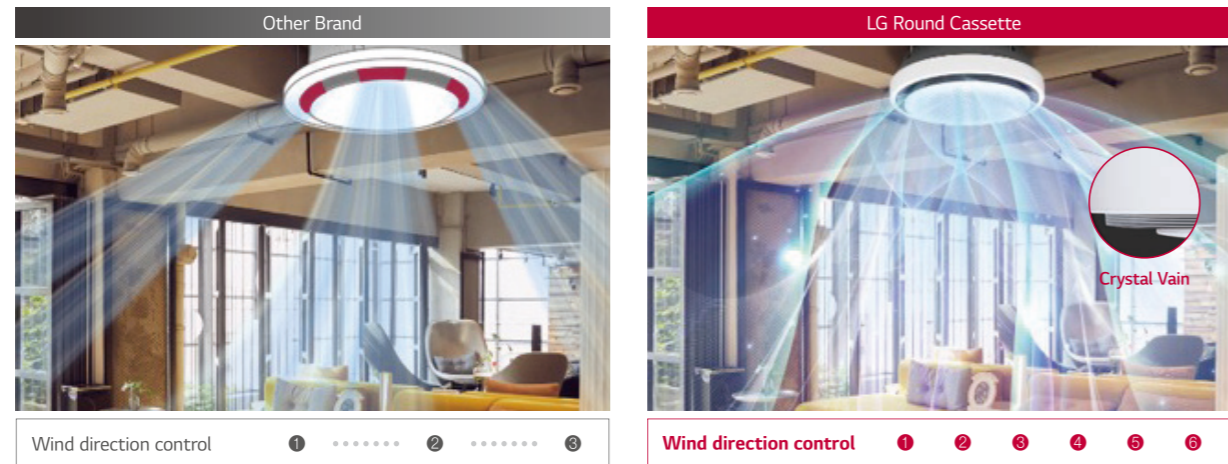

Powerful and Quiet Air Flow

3D fan increases airflow by 5% and noise reduction technology makes a quieter, more comfortable space.

Full 3D Fan, Air flow rate 5% ↑

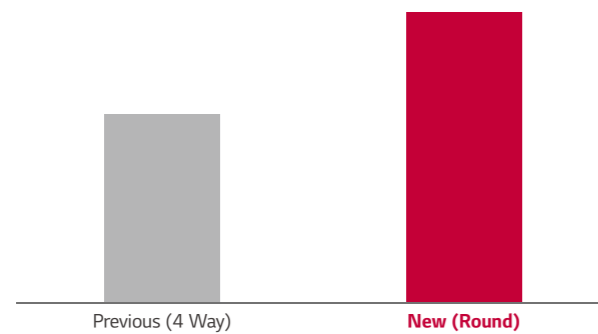

Full 3D Fan, Low noise

※ 48 kbtu, Low flow rate



30% Faster in Cooling

Larger airflow rate, cooling rate is faster than 30%.



※ Based on test results from LG chamber; this image is designed to help customers understand. Experimental environment: height 3.2m, 48 kbtu, cooling mode, high flow rate, horizontal air flow direction

ARNU24GTYA4 / ARNU36GTYA4 / ARNU48GTYA4



MODEL	UNIT	ARNU24GTYA4	ARNU36GTYA4	ARNU48GTYA4
Cooling Capacity	kW	7.1	10.6	14.1
Heating Capacity	kW	8.0	11.9	15.9
Power Input (H / M / L)	Nominal W	44 / 36 / 29	63 / 47 / 36	98 / 70 / 44
Dimensions (W x H x D)	Body mm	1,050 x 330 x 1,050	1,050 x 330 x 1,050	1,050 x 330 x 1,050
	Shipping mm	1,137 x 395 x 1,132	1,137 x 395 x 1,132	1,137 x 395 x 1,132
Fan	Type	3D Turbo Fan	3D Turbo Fan	3D Turbo Fan
	Motor Output x Number W	157 x 1	157 x 1	157 x 1
	Air Flow Rate (H / M / L) m3/min	22 / 21 / 19	27 / 24 / 21	32 / 28 / 23
	Motor Type	BLDC	BLDC	BLDC
Air Filter		Long life	Long life	Long life
Pipe Connections	Liquid Side mm (inch)	Ø9.52 (3/8)	Ø9.52 (3/8)	Ø9.52 (3/8)
	Gas Side mm (inch)	Ø15.88 (5/8)	Ø15.88 (5/8)	Ø15.88 (5/8)
	Drain Pipe(Internal Dia.) mm (inch)	Ø25 (1)	Ø25 (1)	Ø25 (1)
Weight	kg	30	30	30
Sound Pressure Level (H / M / L)	dB(A)	39 / 37 / 34	43 / 39 / 37	47 / 44 / 39
Sound Power Level (H / M / L)	dB(A)	48 / 46 / 43	52 / 48 / 46	56 / 53 / 48
Power Supply	Ø, V, Hz	1, 220-240, 50	1, 220-240, 50	1, 220-240, 50
Communication Cable (VCTF-SB)	mm ² x cores	1.0 - 1.5 x 2C	1.0 - 1.5 x 2C	1.0 - 1.5 x 2C

Note :

1. Performance tested under EN14511

2. Capacities are based on the following conditions

- Cooling : Indoor temp. 27°C (80.6°F) DB / 19°C (66.2°F) WB, Outdoor temp. 35°C (95°F) DB / 24°C (75.2°F) WB, Interconnecting piping length 7.5m, Level difference of zero

- Heating : Indoor temp. 20°C (68°F) DB / 15°C (59°F) WB, Outdoor temp. 7°C (44.6°F) DB / 6°C (42.8°F) WB, Interconnecting piping length 7.5m, Level difference of zero

3. Due to our policy of innovation, some specifications may be changed without notification

Accessories

CHASSIS	ARNU24GTYA4	ARNU36GTYA4	ARNU48GTYA4
Drain Pump		○	
Cassette Cover		-	
Refrigerant Leakage Detector		PRLDNVSO	
EEV Kit		-	
Independent Power Module		PRIPO	
Robot Cleaner		-	
Pre Filter (Washable)		○	
Ion Generator		-	
CO2 Sensor		-	
Ventilation Kit		-	
IR Receiver		-	
Zone Controller		-	
Dry Contact (with additional accessory)		PDRYCB000 (1 point contact), PDRYCB320 (Universal input), PDRYCB400 (2 points input), PDRYCB500 (Modbus)	
External Input (1 Point)		○	
Wi-Fi		PWFMDD200	
Human detection sensor		-	
Floor Temperature Sensor		-	
Air cleaning kit		-	
Elevation Grille		-	

※ ○ : Applied, - : Not applied

Option : Refer to model name in table



Features & Benefits

- Easy and flexible duct adjusts air volume with External Static Pressure (ESP) control function.
- Minimalist visibility (Hidden within ceiling) to blend seamlessly into any interior

Key Applications

- Office
- Retail
- Hotel
- Residential building

	DUCT	HIGH	MIDDLE	LOW
Smart	Wi-Fi	○	○	○
Energy Efficiency	E.S.P Control	○	○	○
	Drain Pump	○	○	○
	Timer (On / Off)	○	○	○
Comfort	Timer (Weekly)	○	○	○
	Two Thermistor Control	○	○	○
	Group Control	○	○	○

※ ○: Applied, -: Not applied

Wi-Fi Control

Anytime, anywhere access to the unit with Android & iOS-based smartphones.



LG ThinQ

Search "LG ThinQ" on Google market or the App Store to download the app.

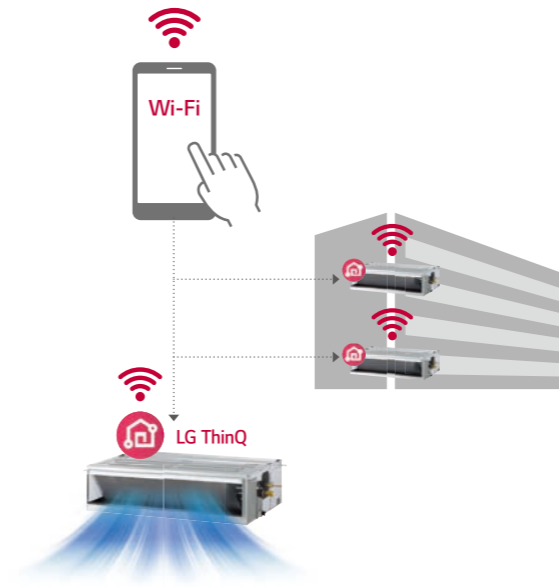

Easy Registration and Log-in

Follow the easy set-up steps that will activate LG ThinQ's user-friendly features.

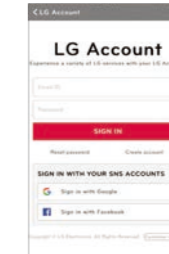

Simple operation for various functions



On/Off, Current Temp



Mode, Set Temp



Vane Control

External Static Pressure (ESP) Control

User has easy access to air volume selection via remote controller using the ESP control function. The BLDC motor can control fan speed and air volume. No additional accessories are necessary to control air flow.

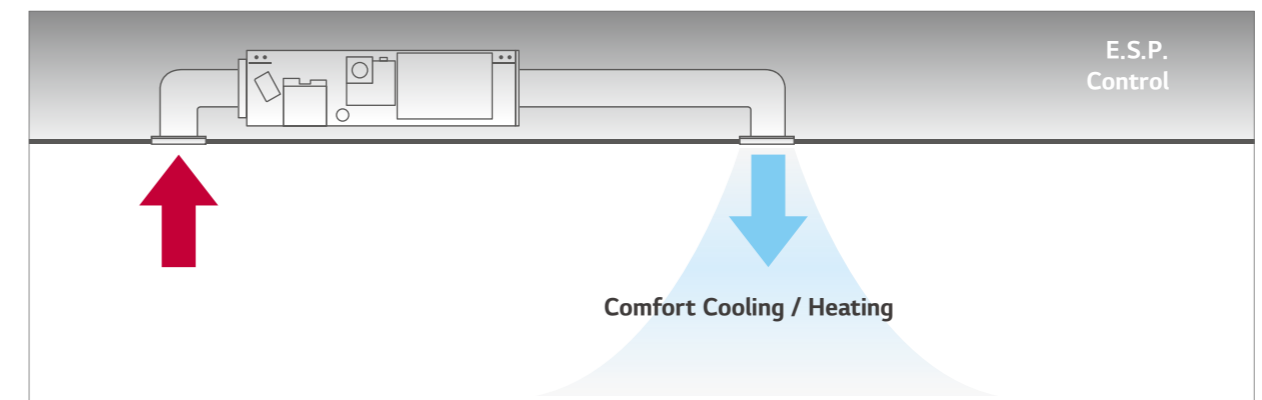
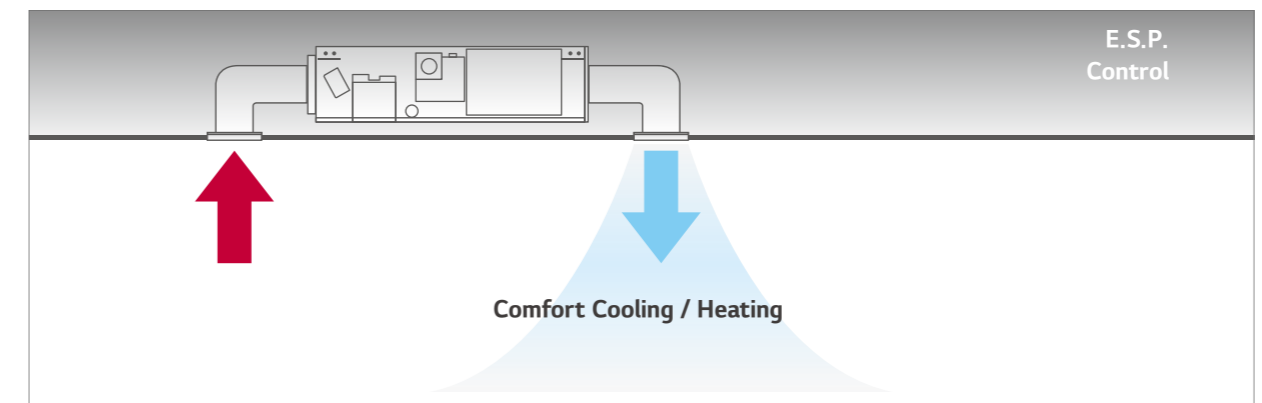

Static Pressure 11- Step Control

Depending on the installation environment, LG's ceiling concealed duct controls the static pressure with 11 steps to provide maximized comfort to any environment.

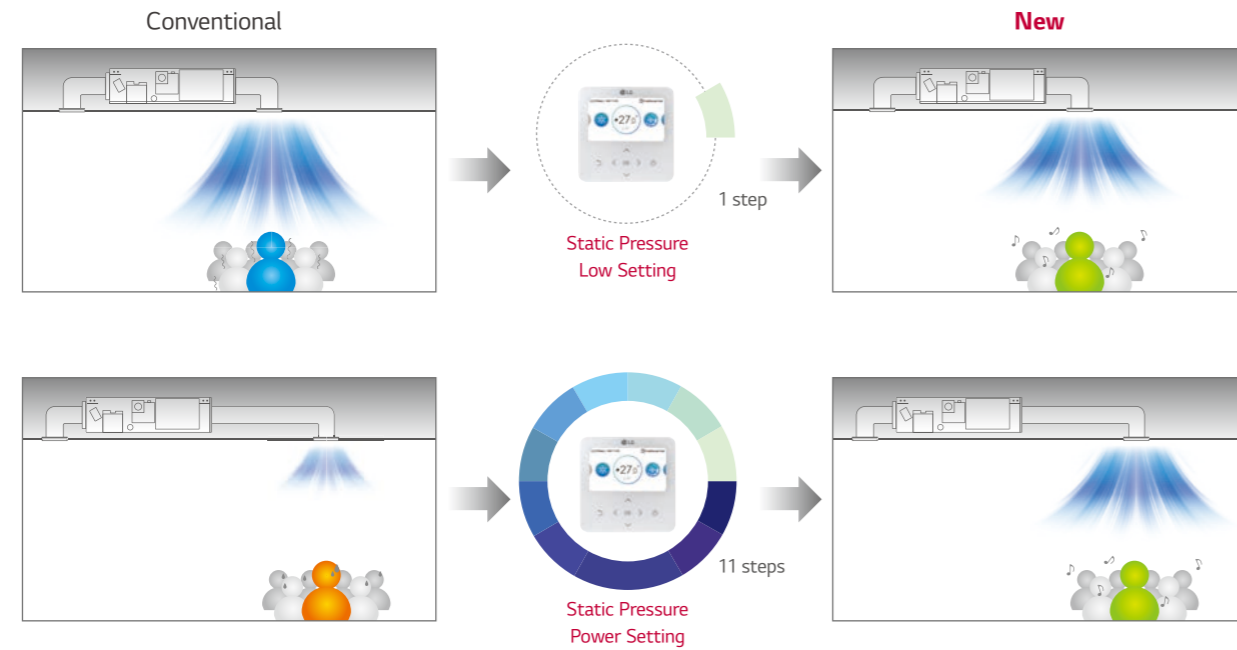

Energy Monitoring

Accumulated electric energy of the indoor unit can be identified with wired remote control, as well as with the central controller. This function is an advantage for energy management.

Install Scene

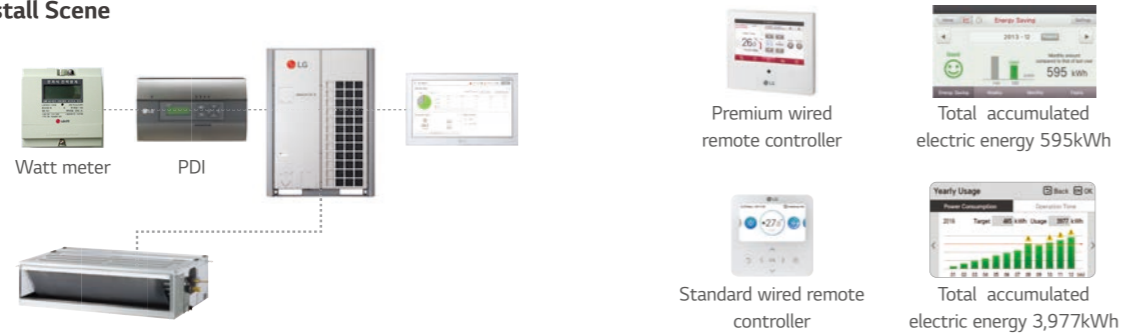

Apply for multistory building



※ Outdoor unit's accumulated electric energy / using rate of individual indoor unit + indoor unit's accumulated electric energy is displayed in wired remote controller, only when central controller, digital integrating electricity meter and PDI are installed and PDI, outdoor unit and indoor unit are connected with power wire. Only total accumulated electric energy is displayed in standard wired remote controller. In premium wired remote controller, that are displayed into week / month / year.

Multiple Room Operation

Using a spiral duct (Embedded or flexible type) and stream chamber, it is possible to operate cooling / heating for several rooms simultaneously.

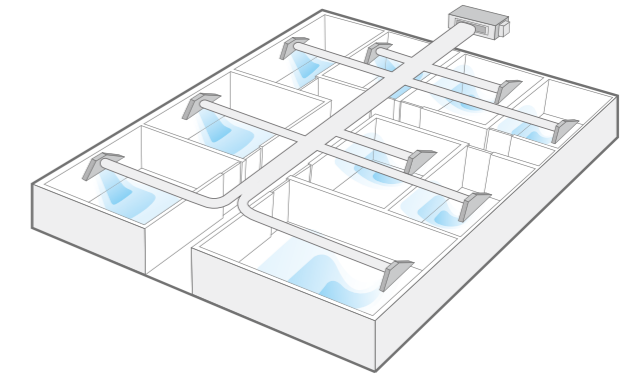

Filter Alert

The alarm is activated when the filter needs to be cleaned, and the time remaining for cleaning is displayed on the screen.

Remain Time Until Indoor Filter Cleaning + Alarm



Flexible Installation

(Low Static Duct and Low Duct Slim Only)

The alarm is activated when the filter needs to be cleaned, and the time remaining for cleaning is displayed on the screen.

Air intake at the rear or bottom

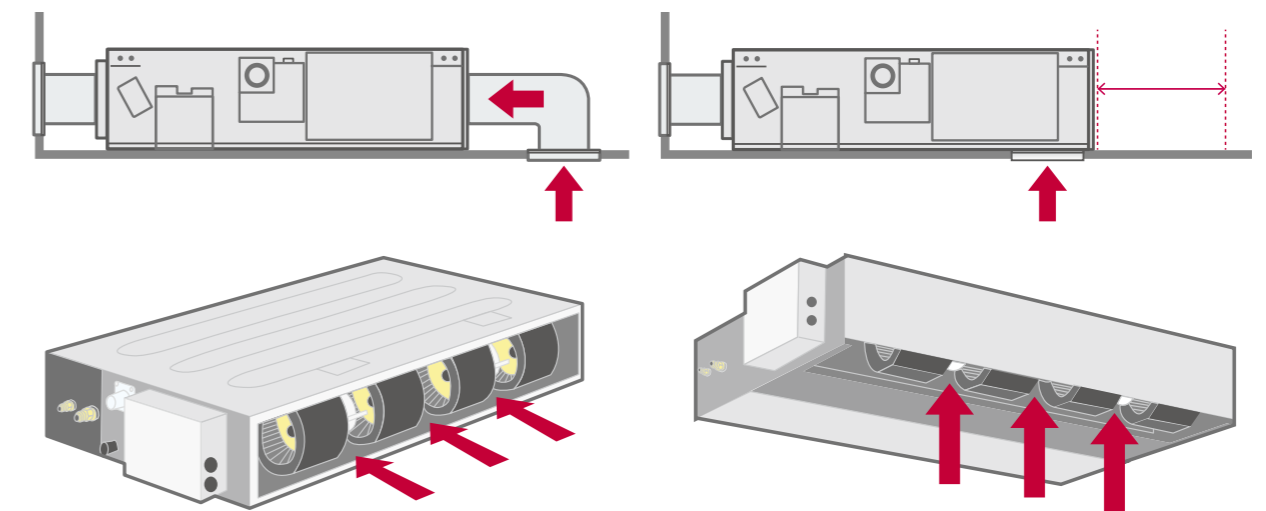

Minimized Height

New mid-static ducts provide ideal solution for installation in limited space.

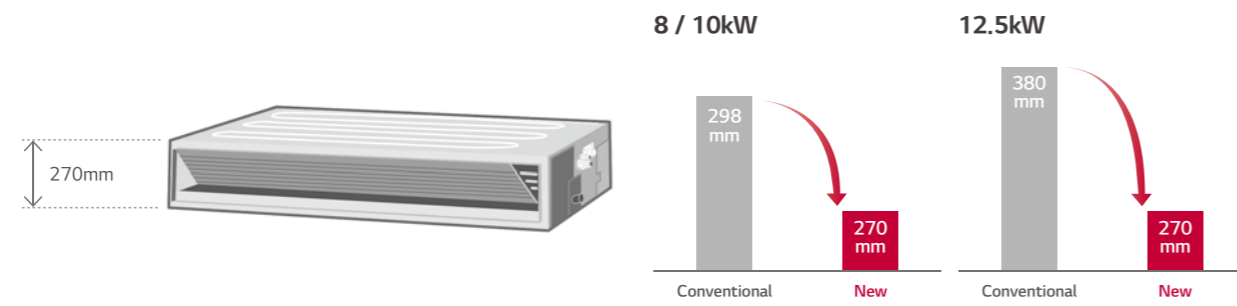

Two Thermistors Control

The indoor temperature can be checked using the thermistors in the remote controller as well as from the indoor unit. There may be a significant difference between ceiling and floor air temperature. Two thermistors can optimise indoor air temperature for a more comfortable environment.

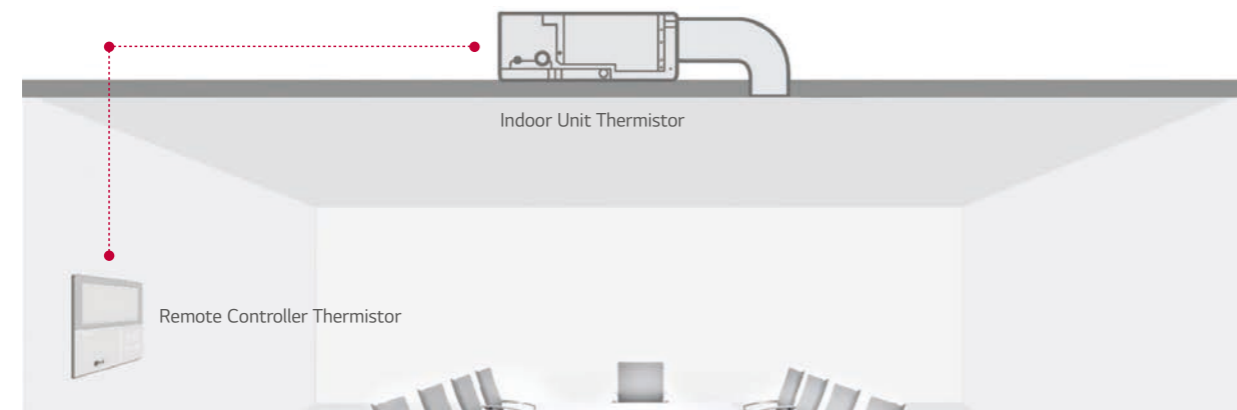

1 Point External Input (On / Off Control)

Indoor unit can be controlled by external devices without dry contact, so customer can save cost of installation.

Connection between an indoor unit and external devices directly

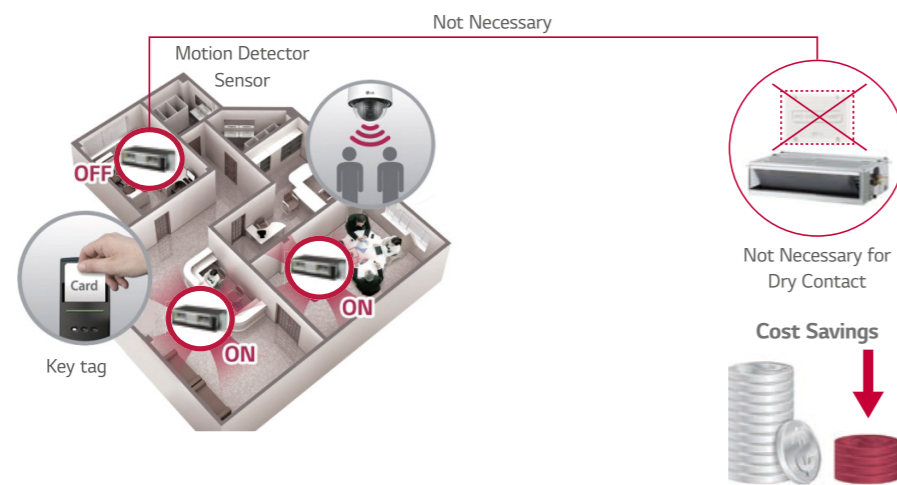

※ In case of needing more functions beside on / off control, a dry contact is required to be installed.

ARNU07GM1A4 / ARNU09GM1A4
ARNU12GM1A4 / ARNU15GM1A4
ARNU18GM1A4 / ARNU24GM1A4



MODEL	UNIT	ARNU07GM1A4	ARNU09GM1A4	ARNU12GM1A4	ARNU15GM1A4	ARNU18GM1A4	ARNU24GM1A4	
Cooling Capacity	kW	2.2	2.8	3.6	4.5	5.6	7.1	
Heating Capacity	kW	2.5	3.2	4.0	5.0	6.3	8.0	
Power Input (H / M / L)	Nominal W	39 / 30 / 25	40 / 32 / 26	46 / 38 / 31	67 / 53 / 46	85 / 63 / 55	91 / 74 / 58	
Dimensions (W x H x D)	Body	mm	900 x 270 x 700	900 x 270 x 700	900 x 270 x 700	900 x 270 x 700	900 x 270 x 700	
	Shipping	mm	1,100 x 338 x 773	1,100 x 338 x 773	1,100 x 338 x 773	1,100 x 338 x 773	1,100 x 338 x 773	
Fan	Type		Sirocco Fan	Sirocco Fan	Sirocco Fan	Sirocco Fan	Sirocco Fan	
	Motor Output x Number	W x No.	136 x 1	136 x 1	136 x 1	136 x 1	136 x 1	
	Air Flow Rate (H / M / L)	m ³ /min	9.0 / 7.5 / 6.0	9.5 / 7.5 / 6.0	11.0 / 9.0 / 7.0	16.0 / 12.0 / 9.0	17.0 / 14.5 / 12.0	19.0 / 16.0 / 14.0
	External Static Pressure (High Mode)	mmAq (Pa)	6 (59)	6 (59)	6 (59)	6 (59)	6 (59)	6 (59)
	Air Flow Rate (H / M / L) (Standard Mode)	m ³ /min	9.0 / 7.5 / 6.0	9.5 / 7.5 / 6.0	11.0 / 9.0 / 7.0	16.0 / 12.0 / 9.0	17.0 / 14.5 / 12.0	19.0 / 16.0 / 14.0
	External Static Pressure (Standard Mode)	mmAq (Pa)	2.5 (25)	2.5 (25)	2.5 (25)	2.5 (25)	2.5 (25)	2.5 (25)
	Motor Type		BLDC	BLDC	BLDC	BLDC	BLDC	BLDC
Air Filter		Pre Filter	Pre Filter	Pre Filter	Pre Filter	Pre Filter	Pre Filter	
Pipe Connections	Liquid Side	mm (inch)	Ø6.35 (1/4)	Ø6.35 (1/4)	Ø6.35 (1/4)	Ø6.35 (1/4)	Ø9.52 (3/8)	
	Gas Side	mm (inch)	Ø12.7 (1/2)	Ø12.7 (1/2)	Ø12.7 (1/2)	Ø12.7 (1/2)	Ø15.88 (5/8)	
	Drain Pipe (Internal Dia.)	mm (inch)	25 (1)	25 (1)	Ø25 (1)	Ø25 (1)	Ø25 (1)	
Weight	Body	kg	25.5	25.5	25.5	25.5	26.5	
Sound Pressure Levels (H / M / L)		dB(A)	26 / 24 / 23	27 / 25 / 23	27 / 25 / 23	30 / 27 / 23	32 / 29 / 26	
Sound Power Levels (H / M / L)		dB(A)	55 / 54 / 51	55 / 54 / 52	56 / 54 / 52	59 / 57 / 55	59 / 58 / 56	
Power Supply	Ø, V, Hz		1, 220-240, 50	1, 220-240, 50	1, 220-240, 50	1, 220-240, 50	1, 220-240, 50	
Transmission Cable		mm ²	1.0 - 1.5 x 2C	1.0 - 1.5 x 2C	1.0 - 1.5 x 2C	1.0 - 1.5 x 2C	1.0-1.5 x 2C	

Note :
1. Performance tested under EN14511
2. Capacities are based on the following conditions
- Cooling : Indoor temp. 27°C (80.6°F) DB / 19°C (66.2°F) WB, Outdoor temp. 35°C (95°F) DB / 24°C (75.2°F) WB, Interconnecting piping length 7.5m, Level difference of zero
- Heating : Indoor temp. 20°C (68°F) DB / 15°C (59°F) WB, Outdoor temp. 7°C (44.6°F) DB / 6°C (42.8°F) WB, Interconnecting piping length 7.5m, Level difference of zero
3. Due to our policy of innovation, some specifications may be changed without notification

Accessories

CHASSIS	ARNU07GM1A4	ARNU09GM1A4	ARNU12GM1A4	ARNU15GM1A4	ARNU18GM1A4	ARNU24GM1A4
Drain Pump					○	
Cassette Cover					-	
Refrigerant Leakage Detector					PRLDNVS0	
EEV Kit					PRGK024A0 (-5.6kW)	
Independent Power Module					PRIPO	
Robot Cleaner					-	
Pre Filter (Washable)					○	
Ion Generator					-	
CO ₂ Sensor					-	
Ventilation Kit					-	
IR Receiver					PWLRVN000	
Zone Controller					ABZCA	
Dry Contact (with additional accessory)					PDRYCB000 (1 point contact), PDRYCB320 (Universal input), PDRYCB400 (2 points input), PDRYCB500 (Modbus)	
External Input (1 point)					○	
Wi-Fi					PWFMD200	

※ ○ : Applied, - : Not applied
Option : Refer to model name in table

ARNU28GM2A4 / ARNU36GM2A4
ARNU42GM2A4 / ARNU48GM3A4
ARNU54GM3A4

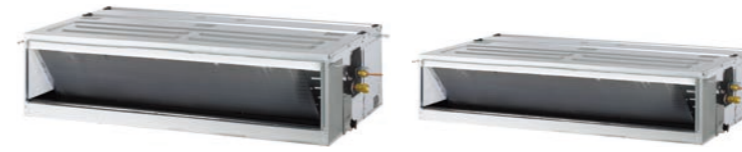

MODEL	UNIT	ARNU28GM2A4	ARNU36GM2A4	ARNU42GM2A4	ARNU48GM3A4	ARNU54GM3A4	
Cooling Capacity	kW	8.2	10.6	12.3	14.1	15.8	
Heating Capacity	kW	9.2	11.9	13.8	15.9	18.0	
Power Input (H / M / L)	Nominal W	123 / 81 / 57	184 / 123 / 81	231 / 162 / 111	172 / 105 / 65	260 / 215 / 172	
Dimensions (W x H x D)	Body	mm	1,250 x 270 x 700	1,250 x 270 x 700	1,250 x 270 x 700	1,250 x 360 x 700	
	Shipping	mm	1,450 x 338 x 773	1,450 x 338 x 773	1,450 x 338 x 773	1,450 x 428 x 773	
Fan	Type		Sirocco Fan	Sirocco Fan	Sirocco Fan	Sirocco Fan	
	Motor Output x Number	W x No.	350 x 1	350 x 1	350 x 1	350 x 1	
	Air Flow Rate (H / M / L)	m ³ /min	28.0 / 24.0 / 21.0	32.0 / 28.0 / 24.0	38.0 / 33.0 / 28.0	40.0 / 34.0 / 28.0	50.0 / 45.0 / 40.0
	External Static Pressure (High Mode)	mmAq (Pa)	6 (59)	6 (59)	6 (59)	6 (59)	6 (59)
	Air Flow Rate (H / M / L) (Standard Mode)	m ³ /min	28.0 / 24.0 / 21.0	32.0 / 28.0 / 24.0	38.0 / 33.0 / 28.0	40.0 / 34.0 / 28.0	50.0 / 45.0 / 40.0
	External Static Pressure (Standard Mode)	mmAq (Pa)	5 (49)	5 (49)	5 (49)	5 (49)	5 (49)
	Motor Type		BLDC	BLDC	BLDC	BLDC	BLDC
Air Filter		Pre Filter	Pre Filter	Pre Filter	Pre Filter	Pre Filter	
Pipe Connections	Liquid Side	mm (inch)	Ø9.52 (3/8)	Ø9.52 (3/8)	Ø9.52 (3/8)	Ø9.52 (3/8)	
	Gas Side	mm (inch)	Ø15.88 (5/8)	Ø15.88 (5/8)	Ø15.88 (5/8)	Ø19.05 (3/4)	
	Drain Pipe (Internal Dia.)	mm (inch)	Ø25 (1)	Ø25 (1)	Ø25 (1)	Ø25 (1)	
Weight	Body	kg	38.0	38.0	39.5	44.0	
Sound Pressure Levels (H / M / L)		dB(A)	36 / 34 / 33	37 / 36 / 34	38 / 37 / 36	39 / 37 / 35	
Sound Power Levels (H / M / L)		dB(A)	59 / 57 / 55	60 / 59 / 57	62 / 61 / 60	63 / 60 / 59	
Power Supply	Ø, V, Hz		1, 220-240, 50	1, 220-240, 50	1, 220-240, 50	1, 220-240, 50	
Transmission Cable		mm ²	1.0 - 1.5 x 2C	1.0 - 1.5 x 2C	1.0 - 1.5 x 2C	1.0 - 1.5 x 2C	

Note :
1. Performance tested under EN14511
2. Capacities are based on the following conditions
- Cooling : Indoor temp. 27°C (80.6°F) DB / 19°C (66.2°F) WB, Outdoor temp. 35°C (95°F) DB / 24°C (75.2°F) WB, Interconnecting piping length 7.5m, Level difference of zero
- Heating : Indoor temp. 20°C (68°F) DB / 15°C (59°F) WB, Outdoor temp. 7°C (44.6°F) DB / 6°C (42.8°F) WB, Interconnecting piping length 7.5m, Level difference of zero
3. Due to our policy of innovation, some specifications may be changed without notification

Accessories

CHASSIS	ARNU28GM2A4	ARNU36GM2A4	ARNU42GM2A4	ARNU48GM3A4	ARNU54GM3A4
Drain Pump					○
Cassette Cover					-
Refrigerant Leakage Detector					PRLDNVS0
EEV Kit					-
Independent Power Module					PRIPO
Robot Cleaner					-
Pre Filter (Washable)					○
Ion Generator					-
CO ₂ Sensor					-
Ventilation Kit					-
IR Receiver					PWLRVN000
Zone Controller					ABZCA
Dry Contact (with additional accessory)					PDRYCB000 (1 point contact), PDRYCB320 (Universal input), PDRYCB400 (2 points input), PDRYCB500 (Modbus)
External Input (1 point)					○
Wi-Fi					PWFMD200

※ ○ : Applied, - : Not applied
Option : Refer to model name in table

ARNU76GB8A4 / ARNU96GB8A4



MODEL	UNIT	ARNU76GB8A4	ARNU96GB8A4
Cooling Capacity	kW	22.4	28.0
Heating Capacity	kW	25.2	31.5
Power Input (H / M / L)	Nominal W	765 / 500 / 500	800 / 750 / 750
Dimensions (W x H x D)	Body	1,562 x 460 x 688	1,562 x 460 x 688
	Shipping	1,806 x 537 x 825	1,806 x 537 x 825
Fan	Type	Sirocco Fan	Sirocco Fan
	Motor Output x Number	W x No.	375 x 2
	Air Flow Rate (H / M / L) (High Mode-Factory Set)	m³/min	60.0 / 50.0 / 50.0
	External Static Pressure (High Mode)	mmAq (Pa)	22 (216)
	Air Flow Rate (H / M / L) (Standard Mode)	m³/min	64.0 / 50.0 / 50.0
	External Static Pressure (Standard Mode)	mmAq (Pa)	15 (147)
	Motor Type		BLDC
Air Filter		Pre Filter	Pre Filter
Pipe Connections	Liquid Side	mm (inch)	Ø9.52 (3/8)
	Gas Side	mm (inch)	Ø19.05 (3/4)
	Drain Pipe (Internal Dia.)	mm (inch)	Ø25 (1)
Weight	Body kg	87.0	87.0
Power Supply	Ø, V, Hz	1, 220-240, 50	1, 220-240, 50
Transmission Cable	mm²	1.0 - 1.5 x 2C	1.0 - 1.5 x 2C

Note :
 1. Performance tested under EN14511
 2. Capacities are based on the following conditions
 - Cooling : Indoor temp. 27°C (80.6°F) DB / 19°C (66.2°F) WB, Outdoor temp. 35°C (95°F) DB / 24°C (75.2°F) WB, Interconnecting piping length 7.5m, Level difference of zero
 - Heating : Indoor temp. 20°C (68°F) DB / 15°C (59°F) WB, Outdoor temp. 7°C (44.6°F) DB / 6°C (42.8°F) WB, Interconnecting piping length 7.5m, Level difference of zero
 3. Due to our policy of innovation, some specifications may be changed without notification

Accessories

CHASSIS	ARNU76GB8A4	ARNU96GB8A4
Drain Pump		○
Cassette Cover		-
Refrigerant Leakage Detector		PRLDNVS0
EEV Kit		○
Independent Power Module		PRIP0
Robot Cleaner		-
Pre Filter (Washable)		○
Ion Generator		-
CO ₂ Sensor		-
Ventilation Kit		-
IR Receiver		PWLRVN000
Zone Controller		ABZCA
Dry Contact (with additional accessory)		PDRYCB000 (1 point contact), PDRYCB320 (Universal input), PDRYCB400 (2 points input), PDRYCB500 (Modbus)
External Input (1 point)		○
Wi-Fi		PWFMD200

※ ○ : Applied, - : Not applied
 Option : Refer to model name in table

ARNU05GL4G4 / ARNU07GL4G4
 ARNU09GL4G4 / ARNU12GL5G4



MODEL	UNIT	ARNU05GL4G4	ARNU07GL4G4	ARNU09GL4G4	ARNU12GL5G4
Cooling Capacity	kW	1.8	2.2	2.8	3.6
Heating Capacity	kW	2.2	2.5	3.2	4
Power Input (H / M / L)	Nominal W	15 / 13 / 11	28 / 24 / 21	28 / 24 / 21	43 / 38 / 35
Dimensions (W x H x D)	Body	700 x 190 x 460	700 x 190 x 460	700 x 190 x 460	900 x 190 x 460
	Shipping	925 x 255 x 561	925 x 255 x 561	925 x 255 x 561	1,125 x 255 x 561
Fan	Type	Sirocco Fan	Sirocco Fan	Sirocco Fan	Sirocco Fan
	Motor Output x Number	W x No.	19 x 1	19 x 1	19 x 1
	Air Flow Rate (H / M / L) (High Mode-Factory Set)	m³/min	7.0 / 6.5 / 5.5	7.5 / 6.5 / 5.5	9.0 / 7.0 / 5.5
	External Static Pressure (High Mode)	mmAq (Pa)	1 (10)	1 (10)	1 (10)
	Air Flow Rate (H / M / L) (Standard Mode)	m³/min	7.0 / 6.5 / 5.5	7.5 / 6.5 / 5.5	9.0 / 7.0 / 5.5
	External Static Pressure (Standard Mode)	mmAq (Pa)	0(0)	0(0)	0(0)
	Motor Type		BLDC	BLDC	BLDC
Air Filter		Pre Filter	Pre Filter	Pre Filter	Pre Filter
Pipe Connections	Liquid Side	mm (inch)	6.35(1/4)	6.35(1/4)	6.35(1/4)
	Gas Side	mm (inch)	12.7(1/2)	12.7(1/2)	12.7(1/2)
	Drain Pipe (Internal Dia.)	mm (inch)	Ø25.4(1)	Ø25.4(1)	Ø25.4(1)
Weight	Body kg	14.6(32.2)	14.6(32.2)	14.6(32.2)	20(44.1)
Sound Pressure Levels (H / M / L)	dB(A)	25 / 24 / 22	26 / 24 / 22	28 / 25 / 22	29 / 27 / 25
Sound Power Levels (H / M / L)	dB(A)	37 / 36 / 34	38 / 37 / 33	40 / 37 / 34	41 / 38 / 38
Power Supply	Ø, V, Hz	220 - 230 - 240, 1,50/60	220 - 230 - 240, 1,50/60	220 - 230 - 240, 1,50/60	220 - 230 - 240, 1,50/60
Transmission Cable	mm²	1.0-1.5 x 2C	1.0-1.5 x 2C	1.0-1.5 x 2C	1.0-1.5 x 2C

Note :
 1. Performance tested under EN14511
 2. Capacities are based on the following conditions
 - Cooling : Indoor temp. 27°C (80.6°F) DB / 19°C (66.2°F) WB, Outdoor temp. 35°C (95°F) DB / 24°C (75.2°F) WB, Interconnecting piping length 7.5m, Level difference of zero
 - Heating : Indoor temp. 20°C (68°F) DB / 15°C (59°F) WB, Outdoor temp. 7°C (44.6°F) DB / 6°C (42.8°F) WB, Interconnecting piping length 7.5m, Level difference of zero
 3. Due to our policy of innovation, some specifications may be changed without notification

Accessories

CHASSIS	ARNU05GL4G4	ARNU07GL4G4	ARNU09GL4G4	ARNU12GL5G4
Drain Pump			○	
Cassette Cover			-	
Refrigerant Leakage Detector			PRLDNVS0	
EEV Kit			PRGK024A0	
Independent Power Module			PRIP0	
Robot Cleaner			-	
Pre Filter (Washable)			○	
Ion Generator			-	
CO ₂ Sensor			-	
Ventilation Kit			-	
IR Receiver			PWLRVN000	
Zone Controller			ABZCA	
Dry Contact (with additional accessory)			PDRYCB000 (1 point contact), PDRYCB320 (Universal input), PDRYCB400 (2 points input), PDRYCB500 (Modbus)	
External Input (1 point)			○	
Wi-Fi			PWFMD200	

※ ○ : Applied, - : Not applied
 Option : Refer to model name in table

ARNU15GL5G4 / ARNU18GL5G4
ARNU21GL6G4 / ARNU24GL6G4



MODEL	UNIT	ARNU15GL5G4	ARNU18GL5G4	ARNU21GL6G4	ARNU24GL6G4
Cooling Capacity	kW	4.5	5.6	6.3	7.1
Heating Capacity	kW	5	6.3	7.1	8
Power Input (H / M / L)	Nominal W	54 / 45 / 38	57 / 39 / 30	65 / 50 / 42	81 / 59 / 43
Dimensions (W x H x D)	Body	mm	900 x 190 x 460	900 x 190 x 460	1,100 x 190 x 460
	Shipping	mm	1,125 x 255 x 561	1,125 x 255 x 561	1,325 x 255 x 561
Fan	Type		Sirocco Fan	Sirocco Fan	Sirocco Fan
	Motor Output x Number	W x No.	19 x 1+5x 1	19 x 1+5x 1	19 x 2
	Air Flow Rate (H / M / L) (High Mode-Factory Set)	m³/min	12.5 / 10.0 / 8.5	15.0 / 12.5 / 10.0	17.5 / 14.0 / 12.0
	External Static Pressure (High Mode)	mmAq (Pa)	1 (10)	1 (10)	1 (10)
	Air Flow Rate (H / M / L) (Standard Mode)	m³/min	12.5 / 10.0 / 8.5	15.0 / 12.5 / 10.0	17.5 / 14.0 / 12.0
	External Static Pressure (Standard Mode)	mmAq (Pa)	0(0)	0(0)	0(0)
	Motor Type		BLDC	BLDC	BLDC
Air Filter		Pre Filter	Pre Filter	Pre Filter	Pre Filter
Pipe Connections	Liquid Side	mm (inch)	6.35(1/4)	6.35(1/4)	9.52(3/8)
	Gas Side	mm (inch)	12.7(1/2)	12.7(1/2)	15.88(5/8)
	Drain Pipe (Internal Dia.)	mm (inch)	Ø25.4(1)	Ø25.4(1)	Ø25.4(1)
Weight	Body kg	20(44.1)	20(44.1)	22(48.5)	22(48.5)
Sound Pressure Levels (H / M / L)	dB(A)	32 / 29 / 27	35 / 32 / 29	35 / 30 / 29	36 / 33 / 29
Sound Power Levels (H / M / L)	dB(A)	45 / 42 / 40	47 / 45 / 42	53 / 48 / 46	57 / 50 / 47
Power Supply	Ø, V, Hz	220 - 230 - 240, 1,50/60	220 - 230 - 240, 1,50/60	220 - 230 - 240, 1,50/60	220 - 230 - 240, 1,50/60
Transmission Cable	mm²	1.0-1.5 x 2C	1.0-1.5 x 2C	1.0-1.5 x 2C	1.0-1.5 x 2C

Note :
 1. Performance tested under EN14511
 2. Capacities are based on the following conditions
 - Cooling : Indoor temp. 27°C (80.6°F) DB / 19°C (66.2°F) WB, Outdoor temp. 35°C (95°F) DB / 24°C (75.2°F) WB, Interconnecting piping length 7.5m, Level difference of zero
 - Heating : Indoor temp. 20°C (68°F) DB / 15°C (59°F) WB, Outdoor temp. 7°C (44.6°F) DB / 6°C (42.8°F) WB, Interconnecting piping length 7.5m, Level difference of zero
 3. Due to our policy of innovation, some specifications may be changed without notification

Accessories

CHASSIS	ARNU15GL5G4	ARNU18GL5G4	ARNU21GL6G4	ARNU24GL6G4
Drain Pump			○	
Cassette Cover			-	
Refrigerant Leakage Detector		PRLDNVS0		
EEV Kit		PRGK024A0		
Independent Power Module		PRIP0		
Robot Cleaner		-		
Pre Filter (Washable)		○		
Ion Generator		-		
CO ₂ Sensor		-		
Ventilation Kit		-		
IR Receiver		PWLRVN000		
Zone Controller		ABZCA		
Dry Contact (with additional accessory)		PDRYCB000 (1 point contact), PDRYCB320 (Universal input), PDRYCB400 (2 points input), PDRYCB500 (Modbus)		
External Input (1 point)		○		
Wi-Fi		PWFMD200		

※ ○ : Applied, - : Not applied
 Option : Refer to model name in table

ARNU05GL1G4 / ARNU07GL1G4
ARNU09GL1G4



MODEL	UNIT	ARNU05GL1G4	ARNU07GL1G4	ARNU09GL1G4
Cooling Capacity	kW	1.7	2.2	2.8
Heating Capacity	kW	1.9	2.5	3.2
Power Input (H / M / L)	Nominal W	29 / 26 / 24	31 / 28 / 24	39 / 29 / 24
Dimensions (W x H x D)	Body	mm	700 x 190 x 700	700 x 190 x 700
	Shipping	mm	862 x 255 x 781	862 x 255 x 781
Fan	Type		Sirocco Fan	Sirocco Fan
	Motor Output x Number	W x No.	19 x 1	19 x 1
	Air Flow Rate (H / M / L) (High Mode-Factory Set)	m³/min	6.7 / 6.2 / 5.5	7.5 / 6.5 / 5.5
	External Static Pressure (High Mode)	mmAq (Pa)	2.54 (25)	2.54 (25)
	Air Flow Rate (H / M / L) (Standard Mode)	m³/min	6.7 / 6.2 / 5.5	7.5 / 6.5 / 5.5
	External Static Pressure (Standard Mode)	mmAq (Pa)	0 (0)	0 (0)
	Motor Type		BLDC	BLDC
Air Filter		Pre Filter	Pre Filter	Pre Filter
Pipe Connections	Liquid Side	mm (inch)	Ø6.35 (1/4)	Ø6.35 (1/4)
	Gas Side	mm (inch)	Ø12.7 (1/2)	Ø12.7 (1/2)
	Drain Pipe (Internal Dia.)	mm (inch)	Ø25 (1)	Ø25 (1)
Weight	Body kg	17.5	17.5	17.5
Sound Pressure Levels (H / M / L)	dB(A)	25 / 24 / 22	26 / 24 / 22	28 / 25 / 22
Sound Power Levels (H / M / L)	dB(A)	48 / 46 / 45	50 / 47 / 45	53 / 49 / 45
Power Supply	Ø, V, Hz	1, 220-240, 50	1, 220-240, 50	1, 220-240, 50
Transmission Cable	mm²	1.0 - 1.5 x 2C	1.0 - 1.5 x 2C	1.0 - 1.5 x 2C

Note :
 1. Performance tested under EN14511
 2. Capacities are based on the following conditions
 - Cooling : Indoor temp. 27°C (80.6°F) DB / 19°C (66.2°F) WB, Outdoor temp. 35°C (95°F) DB / 24°C (75.2°F) WB, Interconnecting piping length 7.5m, Level difference of zero
 - Heating : Indoor temp. 20°C (68°F) DB / 15°C (59°F) WB, Outdoor temp. 7°C (44.6°F) DB / 6°C (42.8°F) WB, Interconnecting piping length 7.5m, Level difference of zero
 3. Due to our policy of innovation, some specifications may be changed without notification

Accessories

CHASSIS	ARNU05GL1G4	ARNU07GL1G4	ARNU09GL1G4
Drain Pump			○
Cassette Cover			-
Refrigerant Leakage Detector		PRLDNVS0	
EEV Kit		PRGK024A0	
Independent Power Module		PRIP0	
Robot Cleaner		-	
Pre Filter (Washable)		○	
Ion Generator		-	
CO ₂ Sensor		-	
Ventilation Kit		-	
IR Receiver		PWLRVN000	
Zone Controller		ABZCA	
Dry Contact (with additional accessory)		PDRYCB000 (1 point contact), PDRYCB320 (Universal input), PDRYCB400 (2 points input), PDRYCB500 (Modbus)	
External Input (1 point)		○	
Wi-Fi		PWFMD200	

※ ○ : Applied, - : Not applied
 Option : Refer to model name in table

ARNU12GL2G4 / ARNU15GL2G4
ARNU18GL2G4



MODEL		UNIT	ARNU12GL2G4	ARNU15GL2G4	ARNU18GL2G4
Cooling Capacity		kW	3.6	4.5	5.6
Heating Capacity		kW	4.0	5.0	6.3
Power Input (H / M / L)	Nominal	W	41 / 34 / 29	56 / 41 / 34	71 / 56 / 41
Dimensions (W x H x D)	Body	mm	900 x 190 x 700	900 x 190 x 700	900 x 190 x 700
	Shipping	mm	1,062 x 255 x 781	1,062 x 255 x 781	1,062 x 255 x 781
Fan	Type		Sirocco Fan	Sirocco Fan	Sirocco Fan
	Motor Output x Number	W x No.	19 x 1, 5 x 1	19 x 1, 5 x 1	19 x 1, 5 x 1
	Air Flow Rate (H / M / L) (High Mode-Factory Set)	m³/min	10.0 / 8.5 / 7.0	12.5 / 10.0 / 8.5	15.0 / 12.5 / 10.0
	External Static Pressure (High Mode)	mmAq (Pa)	2.54 (25)	2.54 (25)	2.54 (25)
	Air Flow Rate (H / M / L) (Standard Mode)	m³/min	10.0 / 8.5 / 7.0	12.5 / 10.0 / 8.5	15.0 / 12.5 / 10.0
	External Static Pressure (Standard Mode)	mmAq (Pa)	0 (0)	0 (0)	0 (0)
	Motor Type		BLDC	BLDC	BLDC
Air Filter			Pre Filter	Pre Filter	
Pipe Connections	Liquid Side	mm (inch)	Ø6.35 (1/4)	Ø6.35 (1/4)	Ø6.35 (1/4)
	Gas Side	mm (inch)	Ø12.7 (1/2)	Ø12.7 (1/2)	Ø12.7 (1/2)
	Drain Pipe (Internal Dia.)	mm (inch)	Ø25 (1)	Ø25 (1)	Ø25 (1)
Weight	Body	kg	23.0	23.0	23.0
Sound Pressure Levels (H / M / L)		dB(A)	30 / 27 / 25	33 / 30 / 28	35 / 32 / 29
Sound Power Levels (H / M / L)		dB(A)	50 / 47 / 46	54 / 51 / 47	56 / 54 / 51
Power Supply		Ø, V, Hz	1, 220-240, 50	1, 220-240, 50	1, 220-240, 50
Transmission Cable		mm²	1.0 - 1.5 x 2C	1.0 - 1.5 x 2C	1.0 - 1.5 x 2C

Note :
 1. Performance tested under EN14511
 2. Capacities are based on the following conditions
 - Cooling : Indoor temp. 27°C (80.6°F) DB / 19°C (66.2°F) WB, Outdoor temp. 35°C (95°F) DB / 24°C (75.2°F) WB, Interconnecting piping length 7.5m, Level difference of zero
 - Heating : Indoor temp. 20°C (68°F) DB / 15°C (59°F) WB, Outdoor temp. 7°C (44.6°F) DB / 6°C (42.8°F) WB, Interconnecting piping length 7.5m, Level difference of zero
 3. Due to our policy of innovation, some specifications may be changed without notification

Accessories

CHASSIS	ARNU12GL2G4	ARNU15GL2G4	ARNU18GL2G4
Drain Pump		○	
Cassette Cover		-	
Refrigerant Leakage Detector		PRLDNVS0	
EEV Kit		-	
Independent Power Module		PRIP0	
Robot Cleaner		-	
Pre Filter (Washable)		○	
Ion Generator		-	
CO ₂ Sensor		-	
Ventilation Kit		-	
IR Receiver		PWLRVN000	
Zone Controller		ABZCA	
Dry Contact (with additional accessory)		PDRYCB000 (1 point contact), PDRYCB320 (Universal input), PDRYCB400 (2 points input), PDRYCB500 (Modbus)	
External Input (1 point)		○	
Wi-Fi		PWFMD200	

※ ○ : Applied, - : Not applied
 Option : Refer to model name in table

ARNU21GL3G4 / ARNU24GL3G4



MODEL		UNIT	ARNU21GL3G4	ARNU24GL3G4
Cooling Capacity		kW	6.2	7.1
Heating Capacity		kW	7.0	8.0
Power Input (H / M / L)	Nominal	W	72 / 53 / 48	103 / 63 / 48
Dimensions (W x H x D)	Body	mm	1,100 x 190 x 700	1,100 x 190 x 700
	Shipping	mm	1,262 x 255 x 781	1,262 x 255 x 781
Fan	Type		Sirocco Fan	Sirocco Fan
	Motor Output x Number	W x No.	19 x 2	19 x 2
	Air Flow Rate (H / M / L) (High Mode-Factory Set)	m³/min	17.5 / 14.0 / 12.0	20.0 / 16.0 / 12.0
	External Static Pressure (High Mode)	mmAq (Pa)	2.54 (25)	2.54 (25)
	Air Flow Rate (H / M / L) (Standard Mode)	m³/min	17.5 / 14.0 / 12.0	20.0 / 16.0 / 12.0
	External Static Pressure (Standard Mode)	mmAq (Pa)	0 (0)	0 (0)
	Motor Type		BLDC	BLDC
Air Filter			Pre Filter	Pre Filter
Pipe Connections	Liquid Side	mm (inch)	Ø9.52 (3/8)	Ø9.52 (3/8)
	Gas Side	mm (inch)	Ø15.88 (5/8)	Ø15.88 (5/8)
	Drain Pipe (Internal Dia.)	mm (inch)	Ø25 (1)	Ø25 (1)
Weight	Body	kg	27.0	27.0
Sound Pressure Levels (H / M / L)		dB(A)	35 / 29 / 28	36 / 33 / 28
Sound Power Levels (H / M / L)		dB(A)	59 / 55 / 54	63 / 59 / 55
Power Supply		Ø, V, Hz	1, 220-240, 50	1, 220-240, 50
Transmission Cable		mm²	1.0 - 1.5 x 2C	1.0 - 1.5 x 2C

Note :
 1. Performance tested under EN14511
 2. Capacities are based on the following conditions
 - Cooling : Indoor temp. 27°C (80.6°F) DB / 19°C (66.2°F) WB, Outdoor temp. 35°C (95°F) DB / 24°C (75.2°F) WB, Interconnecting piping length 7.5m, Level difference of zero
 - Heating : Indoor temp. 20°C (68°F) DB / 15°C (59°F) WB, Outdoor temp. 7°C (44.6°F) DB / 6°C (42.8°F) WB, Interconnecting piping length 7.5m, Level difference of zero
 3. Due to our policy of innovation, some specifications may be changed without notification

Accessories

CHASSIS	ARNU21GL3G4	ARNU24GL3G4
Drain Pump		○
Cassette Cover		-
Refrigerant Leakage Detector		PRLDNVS0
EEV Kit		PRGK024A0
Independent Power Module		PRIP0
Robot Cleaner		-
Pre Filter (Washable)		○
Ion Generator		-
CO ₂ Sensor		-
Ventilation Kit		-
IR Receiver		PWLRVN000
Zone Controller		ABZCA
Dry Contact (with additional accessory)		PDRYCB000 (1 point contact), PDRYCB320 (Universal input), PDRYCB400 (2 points input), PDRYCB500 (Modbus)
External Input (1 point)		○
Wi-Fi		PWFMD200

※ ○ : Applied, - : Not applied
 Option : Refer to model name in table

ARNU07GM2A4 / ARNU09GM2A4
ARNU12GM2A4 / ARNU15GM2A4
ARNU18GM3A4



MODEL	UNIT	ARNU07GM2A4	ARNU09GM2A4	ARNU12GM2A4	ARNU15GM2A4	ARNU18GM3A4	
Cooling Capacity	kW	2.2	2.8	3.6	4.5	5.6	
Heating Capacity	kW	2.5	3.2	4.0	5.0	6.3	
Power Input (H / M / L)	W	32 / 29 / 27	32 / 29 / 27	33 / 30 / 28	33 / 30 / 28	97 / 70 / 51	
Dimensions (W x H x D)	Body	mm	1,250 x 270 x 700	1,250 x 270 x 700	1,250 x 270 x 700	1,250 x 360 x 700	
	Type		Sirocco Fan	Sirocco Fan	Sirocco Fan	Sirocco Fan	
Motor Output x Number	W x No.		350 x 1	350 x 1	350 x 1	500 x 1	
Fan	Air Flow Rate (H / M / L) (High static Mode - factory set)	m³/min	13.3 / 9.4 / 6.8	13.3 / 9.4 / 6.8	14.8 / 10.2 / 7.4	14.8 / 10.2 / 7.4	32.7 / 26.7 / 23.0
	External Static Pressure	mmAq (Pa)	6 (59)	6 (59)	6 (59)	6 (59)	6 (59)
	Air Flow Rate (H / M / L) (Standard Mode)	m³/min	13.3 / 9.4 / 6.8	13.3 / 9.4 / 6.8	14.8 / 10.2 / 7.4	14.8 / 10.2 / 7.4	32.7 / 26.7 / 23.0
	External Static Pressure	mmAq (Pa)	5 (49)	5 (49)	5 (49)	5 (49)	5 (49)
	Motor type		BLDC	BLDC	BLDC	BLDC	BLDC
Air Filter		-	-	-	-	-	
Pipe Connections	Liquid Side	mm (inch)	Ø9.52 (3/8)	Ø9.52 (3/8)	Ø9.52 (3/8)	Ø9.52 (3/8)	
	Gas Side	mm (inch)	Ø15.88 (5/8)	Ø15.88 (5/8)	Ø15.88 (5/8)	Ø15.88 (5/8)	
	Drain Pipe (Internal Dia.)	mm (inch)	25 (1)	25 (1)	25 (1)	25 (1)	
Net Weight	kg	38	38	38	38	44	
Sound Pressure Levels (H / M / L)	dB(A)	33 / 33 / 32	33 / 33 / 32	34 / 33 / 32	34 / 33 / 32	38 / 36 / 34	
Sound Power Levels (H / M / L)	dB(A)	52 / 52 / 52	52 / 52 / 52	53 / 52 / 52	53 / 52 / 52	52 / 51 / 50	
Power Supply	Ø, V, Hz	1, 220-240, 50	1, 220-240, 50	1, 220-240, 50	1, 220-240, 50	1, 220-240, 50	
Transmission Cable	mm²	1.0 - 1.5 x 2C	1.0 - 1.5 x 2C	1.0 - 1.5 x 2C	1.0 - 1.5 x 2C	1.0 - 1.5 x 2C	

- Note:
- Due to our policy of innovation some specifications may be changed without notification.
 - Wiring cable size must comply with the applicable local and national code. And "Electric characteristics" chapter should be considered for electrical work and design. Especially the power cable and circuit breaker should be selected in accordance with that.
 - Sound pressure level is measured on the rated condition in the anechoic rooms by ISO 3745 standard. Sound power level is measured on the rated condition in the reverberation rooms by ISO 3741 standard. Therefore, these values can be increased owing to ambient conditions during operation.
 - Capacities are net capacities and based on the following conditions. Refer to the Outdoor Unit Specifications for calculating the real capacity.
 - Cooling : Indoor Ambient Temp. 27°CDB / 19°CWB, Outdoor Ambient Temp. 35°CDB / 24°CWB
 - Heating : Indoor Ambient Temp. 20°CDB / 15°CWB, Outdoor Ambient Temp. 7°CDB / 6°CWB
 - Interconnected Pipe is standard length and difference of Elevation (Outdoor - Indoor Unit) is Zero.
 - Sound levels are measured at 50Pa External Static Pressure condition.
 - * : Air flow rate could be different in accordance with External Static Pressure and setting value.

Accessories

CHASSIS	ARNU07GM2A4	ARNU09GM2A4	ARNU12GM2A4	ARNU15GM2A4	ARNU18GM3A4
Drain Pump			○		
Cassette Cover			-		
Refrigerant Leakage Detector			PRLDNVSO		
EEV Kit			-		
Independent Power Module			PRIP0		
Robot Cleaner			-		
Pre Filter (Washable)			○		
Ion Generator			-		
CO ₂ Sensor			-		
Ventilation Kit			-		
IR Receiver			PWLRVN000		
Zone Controller			ABZCA		
Dry Contact (with additional accessory)			PDRYCB000 (1 point contact), PDRYCB320 (Universal input), PDRYCB400 (2 points input), PDRYCB500 (Modbus)		
External Input (1 point)			○		
Wi-Fi			PWFMD200		

※ ○ : Applied, - : Not applied
Option : Refer to model name in table

ARNU24GM3A4 / ARNU28GM3A4
ARNU36GB8A4 / ARNU42GB8A4
ARNU48GB8A4

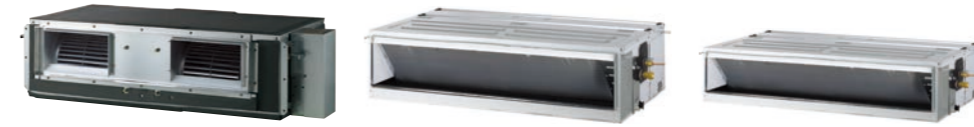

MODEL	UNIT	ARNU24GM3A4	ARNU28GM3A4	ARNU36GB8A4	ARNU42GB8A4	ARNU48GB8A4	
Cooling Capacity	kW	7.1	8.2	10.6	12.3	14.1	
Heating Capacity	kW	8.0	9.2	11.9	13.8	15.9	
Power Input (H / M / L)	W	109 / 83 / 60	109 / 83 / 60	420 / 403 / 478	528 / 497 / 465	538 / 505 / 482	
Dimensions (W x H x D)	Body	mm	1,250 x 360 x 700	1,250 x 360 x 700	1,562 x 460 x 688	1,562 x 460 x 688	
	Type		Sirocco Fan	Sirocco Fan	Sirocco Fan	Sirocco Fan	
Motor Output x Number	W x No.		500 x 1	500 x 1	375 x 2	375 x 2	
Fan	Air Flow Rate (H / M / L) (High static Mode - factory set)	m³/min	35.5 / 30.6 / 26.2	35.5 / 30.6 / 26.2	49.0 / 37.3 / 30.2	54.2 / 41.3 / 31.8	57.2 / 43.0 / 34.0
	External Static Pressure	mmAq (Pa)	6 (59)	6 (59)	18 (176)	18 (176)	18 (176)
	Air Flow Rate (H / M / L) (Standard Mode)	m³/min	35.5 / 30.6 / 26.2	35.5 / 30.6 / 26.2	53.7 / 49.5 / 43.9	55.6 / 50.6 / 45.0	58.0 / 52.3 / 47.3
	External Static Pressure	mmAq (Pa)	5 (49)	5 (49)	9 (88)	9 (88)	9 (88)
	Motor type		BLDC	BLDC	BLDC	BLDC	BLDC
Air Filter		-	-	-	-	-	
Pipe Connections	Liquid Side	mm (inch)	Ø9.52 (3/8)	Ø9.52 (3/8)	Ø9.52 (3/8)	Ø9.52 (3/8)	
	Gas Side	mm (inch)	Ø15.88 (5/8)	Ø15.88 (5/8)	Ø19.05 (3/4)	Ø19.05 (3/4)	
	Drain Pipe (Internal Dia.)	mm (inch)	25 (1)	25 (1)	25 (1)	25 (1)	
Net Weight	kg	44	44	87	87	87	
Sound Pressure Levels (H / M / L)	dB(A)	39 / 37 / 35	39 / 37 / 35	46 / 45 / 42	47 / 46 / 43	47 / 46 / 44	
Sound Power Levels (H / M / L)	dB(A)	53 / 52 / 51	53 / 52 / 51	65 / 64 / 62	66 / 65 / 63	66 / 65 / 64	
Power Supply	Ø, V, Hz	1, 220-240, 50	1, 220-240, 50	1, 220-240, 50	1, 220-240, 50	1, 220-240, 50	
Transmission Cable	mm²	1.0 - 1.5 x 2C	1.0 - 1.5 x 2C	1.0 - 1.5 x 2C	1.0 - 1.5 x 2C	1.0 - 1.5 x 2C	

- Note:
- Due to our policy of innovation some specifications may be changed without notification.
 - Wiring cable size must comply with the applicable local and national code. And "Electric characteristics" chapter should be considered for electrical work and design. Especially the power cable and circuit breaker should be selected in accordance with that.
 - Sound pressure level is measured on the rated condition in the anechoic rooms by ISO 3745 standard. Sound power level is measured on the rated condition in the reverberation rooms by ISO 3741 standard. Therefore, these values can be increased owing to ambient conditions during operation.
 - Capacities are net capacities and based on the following conditions. Refer to the Outdoor Unit Specifications for calculating the real capacity.
 - Cooling : Indoor Ambient Temp. 27°CDB / 19°CWB, Outdoor Ambient Temp. 35°CDB / 24°CWB
 - Heating : Indoor Ambient Temp. 20°CDB / 15°CWB, Outdoor Ambient Temp. 7°CDB / 6°CWB
 - Interconnected Pipe is standard length and difference of Elevation (Outdoor - Indoor Unit) is Zero.
 - Sound levels are measured at 50Pa External Static Pressure condition.
 - * : Air flow rate could be different in accordance with External Static Pressure and setting value.

Accessories

CHASSIS	ARNU24GM3A4	ARNU28GM3A4	ARNU36GB8A4	ARNU42GB8A4	ARNU48GB8A4
Drain Pump			○		
Cassette Cover			-		
Refrigerant Leakage Detector			PRLDNVSO		
EEV Kit			-		
Independent Power Module			PRIP0		
Robot Cleaner			-		
Pre Filter (Washable)			○		
Ion Generator			-		
CO ₂ Sensor			-		
Ventilation Kit			-		
IR Receiver			PWLRVN000		
Zone Controller			ABZCA		
Dry Contact (with additional accessory)			PDRYCB000 (1 point contact), PDRYCB320 (Universal input), PDRYCB400 (2 points input), PDRYCB500 (Modbus)		
External Input (1 point)			○		
Wi-Fi			PWFMD200		

※ ○ : Applied, - : Not applied
Option : Refer to model name in table

Fresh Outdoor Air Supply

The LG Fresh Air Intake Unit (FAU) is the alternative solution for ventilation, which supplies the fresh outdoor air indoors as well as and simultaneously cools and heats the air inside. It means the indoor space can have positive air pressure consistently, which can block cold, hot or contaminated air from outside. This allows the indoor space to have consistent positive air pressure blocking cold air.

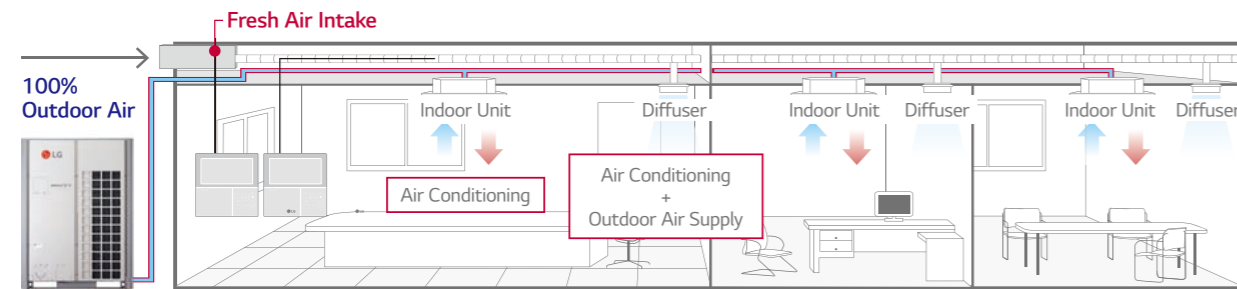

MULTI V 5 Outdoor unit

Economic Operation

Natural outdoor air is utilized as seasons change for cost efficiency.

Spring Season

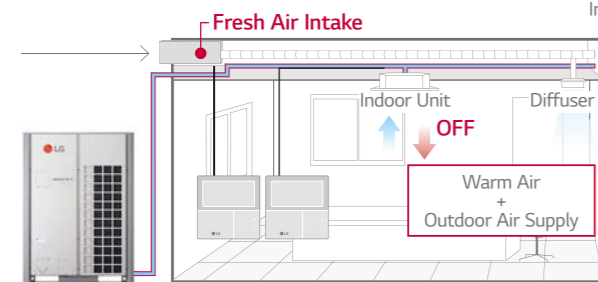

MULTI V 5 Outdoor unit

Autumn Season

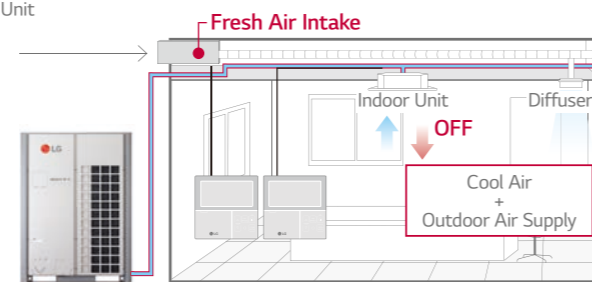

MULTI V 5 Outdoor unit

Installation Scene

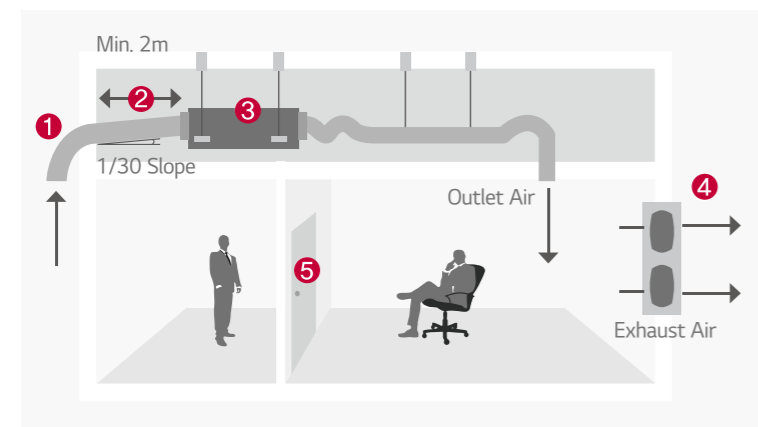

- ① Inlet Hood
- ② Intake Air Duct
- ③ Fresh Air Intake Unit
- ④ Exhaust Fan
- ⑤ Door

ARNU76GB8Z4 / ARNU96GB8Z4



MODEL	UNIT	ARNU76GB8Z4	ARNU96GB8Z4
Cooling Capacity	kW	22.4	28.0
Heating Capacity	kW	21.4	26.7
Power Input (H / M / L)	W	230 / 200 / 200	360 / 230 / 230
Dimensions (W x H x D)	Body	1,562 x 460 x 688	1,562 x 460 x 688
	Shipping	1,806 x 537 x 825	1,806 x 537 x 825
Fan	Type	Sirocco Fan	Sirocco Fan
	Motor Output x Number	W x No.	375 x 1
	Air Flow Rate (H / M / L) (High Mode-Factory Set)	m ³ /min	23.7 / 13.2 / 13.2
	External Static Pressure	mmAq (Pa)	22 (216)
	Motor Type		BLDC
	Air Filter		Long Life Filter
Pipe Connections	Liquid Side	mm (inch)	Ø9.52 (3/8)
	Gas Side	mm (inch)	Ø19.05 (3/4)
	Drain Pipe (Internal Dia.)	mm (inch)	Ø25 (1)
Weight	kg	73.0	
Sound Pressure Levels (H / M / L)	dB(A)	45 / 43 / 43	
Sound Power Levels (H / M / L)	dB(A)	70 / 67 / 67	
Power Supply	∅, V, Hz	1, 220-240, 50	
Transmission Cable	mm ²	1.0 - 1.5 x 2C	

Note : 1. Performance tested under EN14511
 2. Capacities are based on the following conditions
 - Cooling : Indoor temp. 27°C (80.6°F) DB / 19°C (66.2°F) WB, Outdoor temp. 35°C (95°F) DB / 24°C (75.2°F) WB, Interconnecting piping length 7.5m, Level difference of zero
 - Heating : Indoor temp. 20°C (68°F) DB / 15°C (59°F) WB, Outdoor temp. 7°C (44.6°F) DB / 6°C (42.8°F) WB, Interconnecting piping length 7.5m, Level difference of zero
 3. Due to our policy of innovation, some specifications may be changed without notification

CAUTION

1. Operation range (Cooling : 5°C ~ 43°C, Heating : -5°C ~ 43°C) 2. Installation of exhaust fan is recommended for a sealed room. 3. Indoor Unit Connection

NO	CONNECTION CONDITION	COMBINATION
1	Fresh air intake units only are connected with outdoor units	1) The total capacity of fresh air intake unit should be 50 ~ 100% of outdoor unit. 2) The max quantity of fresh air intake is 4 units.
2	Mixture connection with general indoor unit and fresh intake units	1) The total capacity of indoor units (Standard Indoor Unit + Fresh Air Intake Unit) should be 50 ~ 100% of outdoor unit. 2) The total capacity of fresh air intake unit should be less than 30% of the total capacity of indoor units.

Accessories

CHASSIS	ARNU76GB8Z4	ARNU96GB8Z4
Drain Pump		○
Cassette Cover		-
Refrigerant Leakage Detector		PRLDNVSO
EEV Kit		-
Independent Power Module		PRIP0
Robot Cleaner		-
Pre Filter (Washable)		○
Ion Generator		-
CO ₂ Sensor		-
Ventilation Kit		-
IR Receiver		PWLRVN000
Zone Controller		-
Dry Contact (with additional accessory)		PDRYCB000 (1 point contact), PDRYCB320 (Universal input), PDRYCB400 (2 points input), PDRYCB500 (Modbus)
External Input (1 point)		○
Wi-Fi		PWFMD200

※ ○ : Applied, - : Not applied
 Option : Refer to model name in table



Features & Benefits

- Modern design with V-shape and black vane
- Powerful air speed and volume can reach up to 15m

Key Applications

- Retail
- Restaurant
- Shop

	CEILINGS	CEILING & FLOOR CONVERTIBLE	CEILING SUSPENDED
Smart	Wi-Fi	○	○
Fast Cooling & Heating	Jet Cool	○	○
	Sleep mode	○	○
Comfort	Timer (On / Off)	○	○
	Timer (Weekly)	○	○
	Two thermistor control	○	○
	Group control	○	○

※ ○: Applied, -: Not applied

Wi-Fi Control

Access your air conditioner anytime and from anywhere.



LG ThinQ

Search "LG ThinQ" on Google market or the App Store to download the app.

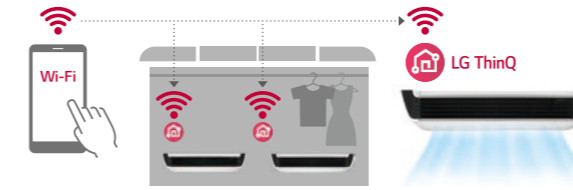

Easy Registration and Log-in

Follow the easy set-up steps that will activate LG ThinQ's impressive feature.

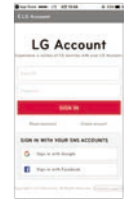

Flexible

The ceiling and floor models can be installed either on the ceiling or on the floor.

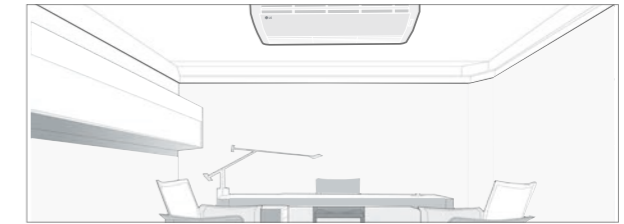
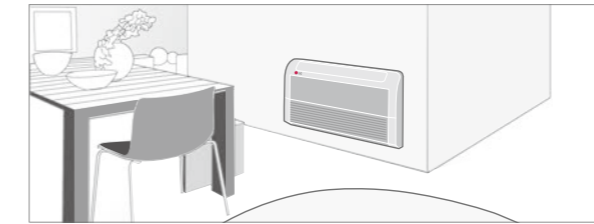

Filter Change Alarm

The filter change alarm informs you when the unit has been operating for 2,400 hours.



One Touch Filter

Filter Change Alarm

Air flow Direction Control

Vertical air flow direction can be adjusted using remote controller, and horizontal air flow direction can be adjusted manually.

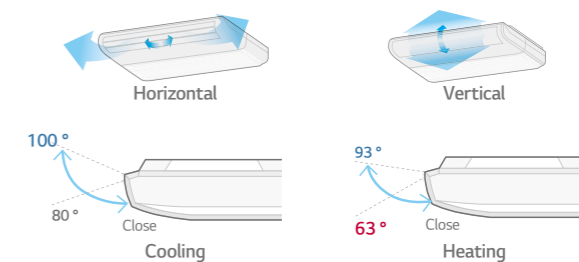

Differentiated Design

Modern elegance design with V-shape and black vane is appropriate for any commercial space. It received iF Design Award.



Powerful Cooling & Heating

High ceiling mode provides powerful cooling and heating up to 4.2m in height from floor, 15m away from ceiling.



One Touch & 2 Piece Filter

Easy in / out filter structure as well as a simplified two-piece filter, which slides out for easy cleaning and maintenance.

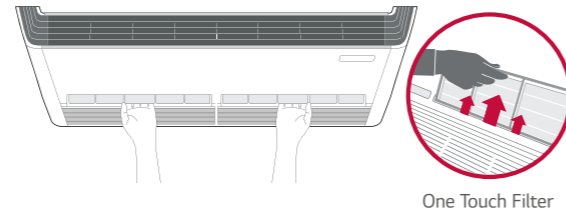

Two Thermistors Control

Users can purchase a wired remote controller that includes a second thermistor, allowing for temperature checks from multiple locations.

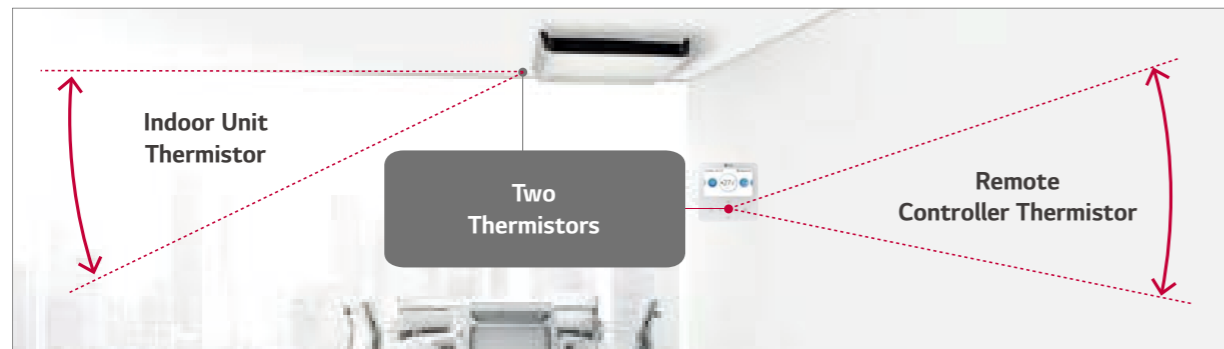

Lined area for notes.

ARNU09GVEA4 / ARNU12GVEA4



MODEL	UNIT	ARNU09GVEA4	ARNU12GVEA4
Cooling Capacity	kW	2.8	3.6
Heating Capacity	kW	3.2	4.0
Power Input (H / M / L)	Nominal W	19 / 15 / 11	28 / 19 / 15
Exterior Color		Morning Fog	Morning Fog
RAL Code		RAL 9001	RAL 9001
Dimensions (W x H x D)	Body mm	900 x 490 x 200	900 x 490 x 200
	Shipping mm	975 x 279 x 562	975 x 279 x 562
Fan	Type	Cross Flow Fan	Cross Flow Fan
	Motor Output x Number	W x No. 27 x 1	27 x 1
	Air Flow Rate (H / M / L)	m ³ /min 7.6 / 6.9 / 6.2	9.2 / 7.6 / 6.9
		cfm 268 / 244 / 219	325 / 268 / 244
	Motor Type	BLDC	BLDC
Air Filter		Pre Filter	Pre Filter
Pipe Connections	Liquid Side mm (inch)	Ø6.35 (1/4)	Ø6.35 (1/4)
	Gas Side mm (inch)	Ø12.7 (1/2)	Ø12.7 (1/2)
	Drain Pipe (Internal Dia.) mm (inch)	Ø16 (5/8)	Ø16 (5/8)
Weight	Body kg	13.3	13.3
Sound Pressure Levels (H / M / L)	dB(A)	36 / 32 / 28	38 / 36 / 30
Sound Power Levels (H / M / L)	dB(A)	55 / 51 / 45	56 / 55 / 49
Power Supply	Ø, V, Hz	1, 220-240, 50	1, 220-240, 50
Transmission Cable	mm ² x cores	1.0 - 1.5 x 2C	1.0 - 1.5 x 2C

Note : 1. Performance tested under EN14511
 2. Capacities are based on the following conditions
 - Cooling : Indoor temp. 27°C (80.6°F) DB / 19°C (66.2°F) WB, Outdoor temp. 35°C (95°F) DB / 24°C (75.2°F) WB, Interconnecting piping length 7.5m, Level difference of zero
 - Heating : Indoor temp. 20°C (68°F) DB / 15°C (59°F) WB, Outdoor temp. 7°C (44.6°F) DB / 6°C (42.8°F) WB, Interconnecting piping length 7.5m, Level difference of zero
 3. Due to our policy of innovation, some specifications may be changed without notification

Accessories

CHASSIS	ARNU09GVEA4	ARNU12GVEA4
Drain Pump	-	-
Refrigerant Leakage Detector		PRLDNVSO
EEV Kit		PRGK024AO
Independent Power Module		PRIPO
Plasma Kit	-	-
Robot Cleaner	-	-
Pre Filter (Washable)		○
Ion Generator	-	-
CO ₂ Sensor	-	-
Ventilation Kit	-	-
IR Receiver	-	-
Zone Controller	-	-
Dry Contact (with additional accessory)		PDRYCB000 (1 point contact), PDRYCB320 (Universal input), PDRYCB400 (2 points input), PDRYCB500 (Modbus)
External Input (1 point)		○
Wi-Fi		PWFMD200 ¹⁾

※ ○ : Applied, - : Not Applied
 Option: Refer to model name in table

ARNU18GV1A4 / ARNU24GV1A4
 ARNU36GV2A4 / ARNU48GV2A4



MODEL	UNIT	ARNU18GV1A4	ARNU24GV1A4	ARNU36GV2A4	ARNU48GV2A4
Cooling Capacity	kW	5.6	7.1	10.6	14.1
Heating Capacity	kW	6.3	8.0	11.9	15.9
Power Input (H / M / L)	Nominal W	23 / 20 / 17	25 / 21 / 17	84 / 77 / 66	91 / 79 / 66
Exterior Color		Morning Fog	Morning Fog	Morning Fog	Morning Fog
RAL Code		RAL 9001	RAL 9001	RAL 9001	RAL 9001
Dimensions (W x H x D)	Body mm	1,200 x 235 x 690	1,200 x 235 x 690	1,600 x 235 x 690	1,600 x 235 x 690
	Shipping mm	1,315 x 320 x 772	1,315 x 320 x 772	1,715 x 320 x 772	1,715 x 320 x 772
Fan	Type	Cross Flow Fan	Cross Flow Fan	Cross Flow Fan	Cross Flow Fan
	Motor Output x Number	W x No. 85.9 x 1	85.9 x 1	125 x 1	125 x 1
	Air Flow Rate (H / M / L)	m ³ /min 13.5 / 12.5 / 12.0	14.0 / 13.0 / 12.0	27.0 / 24.0 / 20.0	29.0 / 24.0 / 20.0
	Motor Type	BLDC	BLDC	BLDC	BLDC
Air Filter		Pre Filter	Pre Filter	Pre Filter	Pre Filter
Pipe Connections	Liquid Side mm (inch)	Ø6.35 (1/4)	Ø9.52 (3/8)	Ø9.52 (3/8)	Ø9.52 (3/8)
	Gas Side mm (inch)	Ø12.7 (1/2)	Ø15.88 (5/8)	Ø15.88 (5/8)	Ø15.88 (5/8)
	Drain Pipe (Internal Dia.) mm (inch)	Ø16 (5/8)	Ø16 (5/8)	Ø16 (5/8)	Ø16 (5/8)
Weight	Body kg	29.0	29.0	37.0	37.0
Sound Pressure Levels (H / M / L)	dB(A)	36 / 34 / 33	37 / 35 / 33	48 / 46 / 44	49 / 47 / 44
Sound Power Levels (H / M / L)	dB(A)	61 / 59 / 56	62 / 59 / 56	68 / 66 / 64	68 / 67 / 66
Power Supply	Ø, V, Hz	1, 220-240, 50	1, 220-240, 50	1, 220-240, 50	1, 220-240, 50
Transmission Cable	mm ² x cores	1.0 - 1.5 x 2C	1.0 - 1.5 x 2C	1.0 - 1.5 x 2C	1.0 - 1.5 x 2C

Note : 1. Performance tested under EN14511
 2. Capacities are based on the following conditions
 - Cooling : Indoor temp. 27°C (80.6°F) DB / 19°C (66.2°F) WB, Outdoor temp. 35°C (95°F) DB / 24°C (75.2°F) WB, Interconnecting piping length 7.5m, Level difference of zero
 - Heating : Indoor temp. 20°C (68°F) DB / 15°C (59°F) WB, Outdoor temp. 7°C (44.6°F) DB / 6°C (42.8°F) WB, Interconnecting piping length 7.5m, Level difference of zero
 3. Due to our policy of innovation, some specifications may be changed without notification

Accessories

CHASSIS	ARNU18GV1A4	ARNU24GV1A4	ARNU36GV2A4	ARNU48GV2A4
Drain Pump	-	-	-	-
Cassette Cover	-	-	-	-
Refrigerant Leakage Detector			PRLDNVSO	
EEV Kit			-	-
Independent Power Module			PRIPO	
Robot Cleaner	-	-	-	-
Pre Filter (Washable)			○	
Ion Generator	-	-	-	-
CO ₂ Sensor	-	-	-	-
Ventilation Kit	-	-	-	-
IR Receiver	-	-	-	-
Zone Controller	-	-	-	-
Dry Contact (with additional accessory)			PDRYCB000 (1 point contact), PDRYCB320 (Universal input), PDRYCB400 (2 points input), PDRYCB500 (Modbus)	
External Input (1 point)			○	
Wi-Fi			PWFMD200	

※ ○ : Applied, - : Not Applied
 Option: Refer to model name in table



Features & Benefits

- 6 way flexible piping
- Cold draft window protection
- Condensation protection

Key Applications

- Residential building
- Historical building
- Hotel

	FLOOR STANDING	CONSOLE	FLOOR STANDING
Smart	Wi-Fi	○	○
Energy Efficiency	Jet Cool	-	○
Health	Ionizer	○	-
Fast Cooling & Heating	Jet Cool	○	-
	Sleep Mode	○	○
Comfort	Timer (On / Off)	○	○
	Timer (Weekly)	○	○
	Two Thermistor Control	○	○
	Group Control	○	○

※ ○: Applied, -: Not applied

Wi-Fi Control

Access your air conditioner anytime and from anywhere.



Air Flow Direction Change

During the cooling operation, the vane adjusts upwards to direct the air flow towards the ceiling. When heating, the vane directs the warm air downwards to balance the room temperature especially for floor.

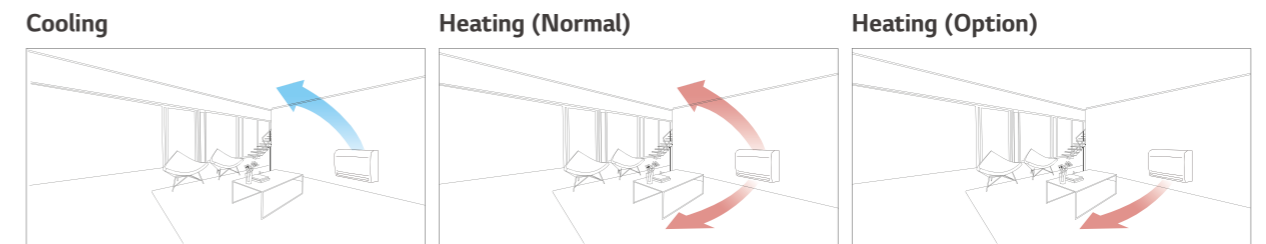

Cold Draft Protection

The console protects cold draft from windows to provide comfortable environment.



5-Step Vane Control

There are 5 different stages to control air flow direction.

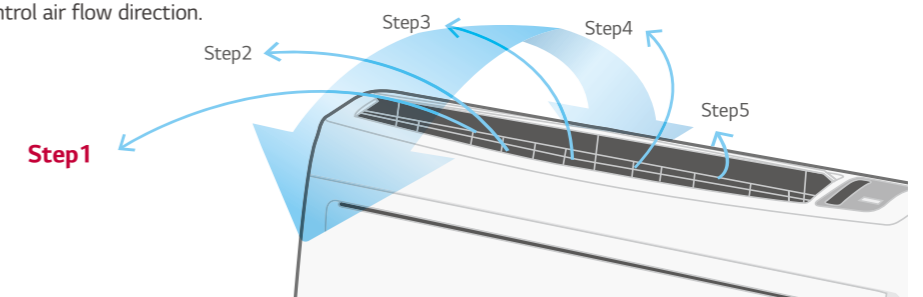

6 Way Flexible Piping

It is possible to install and connect the outdoor unit in 6 different ways. (Right Side, Right Back, Right Floor, Left Side, Left Back, Left Floor)

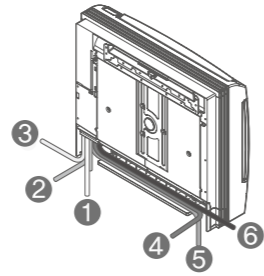

Protect Cold Draft

The floor standing unit protects cold draft coming from window and preventing condensation.

Without Floor Standing

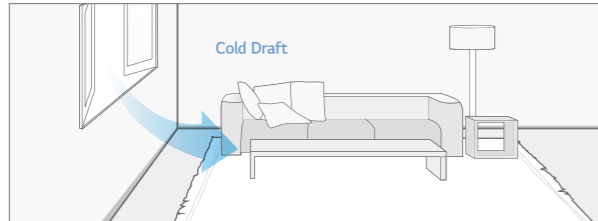

With Floor Standing

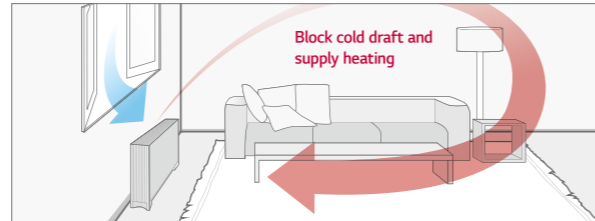

3 Way Flexible Piping

It is possible to install and connect the outdoor unit in 3 different ways. (Side, Back, Floor)

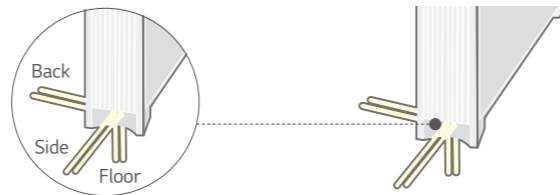

Sliding Type Filter

Easy maintenance and extended product life with sliding type filter.

Sliding type

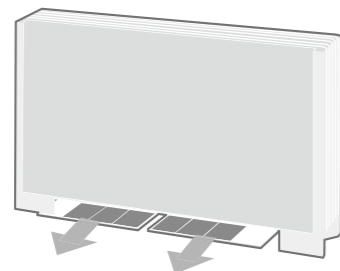

Easy cleaning

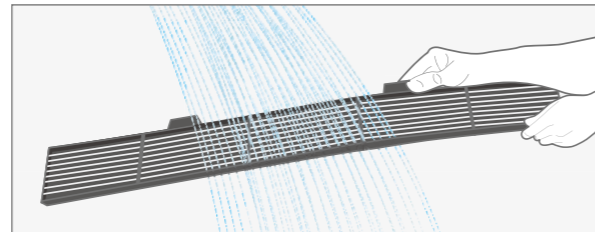

ARNU07GQAA4 / ARNU09GQAA4



MODEL	UNIT	ARNU07GQAA4	ARNU09GQAA4
Cooling Capacity	kW	2.2	2.8
Heating Capacity	kW	2.5	3.2
Power Input (H / M / L)	Nominal W	15 / 12 / 10	15 / 12 / 10
Exterior Color		Morning Fog	Morning Fog
RAL Code		RAL 9001	RAL 9001
Dimensions (W x H x D)	Body mm	700 x 600 x 210	700 x 600 x 210
	Shipping mm	775 x 662 x 284	775 x 662 x 284
Fan	Type	Turbo fan	Turbo fan
	Motor Output x Number W x No.	48 x 1	48 x 1
	Air Flow Rate (H / M / L) m³/min	6.7 / 5.9 / 4.8	6.7 / 5.9 / 4.8
	Motor Type	BLDC	BLDC
Air Filter		Pre Filter	Pre Filter
Pipe Connections	Liquid Side mm (inch)	Ø6.35 (1/4)	Ø6.35 (1/4)
	Gas Side mm (inch)	Ø12.7 (1/2)	Ø12.7 (1/2)
	Drain Pipe (Internal Dia.) mm (inch)	Ø12 (15/32)	Ø12 (15/32)
Weight	Body kg	14.0	14.0
Sound Pressure Levels (H / M / L)	dB(A)	37 / 34 / 28	37 / 34 / 28
Sound Power Levels (H / M / L)	dB(A)	53 / 50 / 44	53 / 50 / 44
Power Supply	Ø, V, Hz	1, 220-240, 50	1, 220-240, 50
Transmission Cable	mm²	1.0 - 1.5 x 2C	1.0 - 1.5 x 2C

Note:
 1. Performance tested under EN14511
 2. Capacities are based on the following conditions
 - Cooling : Indoor temp. 27°C (80.6°F) DB / 19°C (66.2°F) WB, Outdoor temp. 35°C (95°F) DB / 24°C (75.2°F) WB, Interconnecting piping length 7.5m, Level difference of zero
 - Heating : Indoor temp. 20°C (68°F) DB / 15°C (59°F) WB, Outdoor temp. 7°C (44.6°F) DB / 6°C (42.8°F) WB, Interconnecting piping length 7.5m, Level difference of zero
 3. Due to our policy of innovation, some specifications may be changed without notification

Accessories

CHASSIS	ARNU07GQAA4	ARNU09GQAA4
Drain Pump	-	-
Cassette Cover	-	-
Refrigerant Leakage Detector	PRLDNV50	
EEV Kit	PRGK024A0	
Independent Power Module	PRIP0	
Robot Cleaner	-	-
Pre Filter (Washable)	○	
Ion Generator	○	
CO2 Sensor	-	-
Ventilation Kit	-	-
IR Receiver	-	-
Zone Controller	-	-
Dry Contact (with additional accessory)	PDRYCB000 (1 point contact), PDRYCB320 (Universal input), PDRYCB400 (2 points input), PDRYCB500 (Modbus)	
External Input (1 point)	○	
Wi-Fi	PWFMD200	

※ ○ : Applied, - : Not Applied
 Option: Refer to model name in table

ARNU12GQAA4 / ARNU15GQAA4



MODEL	UNIT	ARNU12GQAA4	ARNU15GQAA4
Cooling Capacity	kW	3.6	4.5
Heating Capacity	kW	4.0	5.0
Power Input (H / M / L)	Nominal W	18 / 15 / 13	24 / 19 / 17
Exterior Color		Morning Fog	Morning Fog
RAL Code		RAL 9001	RAL 9001
Dimensions (W x H x D)	Body mm	700 x 600 x 210	700 x 600 x 210
	Shipping mm	775 x 662 x 284	775 x 662 x 284
Fan	Type	Turbo fan	Turbo fan
	Motor Output x Number W x No.	48 x 1	48 x 1
	Air Flow Rate (H / M / L) m³/min	7.5 / 5.9 / 4.8	8.7 / 6.7 / 5.9
	Motor Type	BLDC	BLDC
Air Filter		Pre Filter	Pre Filter
Pipe Connections	Liquid Side mm (inch)	Ø6.35 (1/4)	Ø6.35 (1/4)
	Gas Side mm (inch)	Ø12.7 (1/2)	Ø12.7 (1/2)
	Drain Pipe (Internal Dia.) mm (inch)	Ø12 (15/32)	Ø12 (15/32)
Weight	Body kg	14.0	14.0
Sound Pressure Levels (H / M / L)	dB(A)	39 / 34 / 28	42 / 37 / 31
Sound Power Levels (H / M / L)	dB(A)	56 / 50 / 44	58 / 53 / 50
Power Supply	Ø, V, Hz	1, 220-240, 50	1, 220-240, 50
Transmission Cable	mm²	1.0 - 1.5 x 2C	1.0 - 1.5 x 2C

Note:
 1. Performance tested under EN14511
 2. Capacities are based on the following conditions
 - Cooling : Indoor temp. 27°C (80.6°F) DB / 19°C (66.2°F) WB, Outdoor temp. 35°C (95°F) DB / 24°C (75.2°F) WB, Interconnecting piping length 7.5m, Level difference of zero
 - Heating : Indoor temp. 20°C (68°F) DB / 15°C (59°F) WB, Outdoor temp. 7°C (44.6°F) DB / 6°C (42.8°F) WB, Interconnecting piping length 7.5m, Level difference of zero
 3. Due to our policy of innovation, some specifications may be changed without notification

Accessories

CHASSIS	ARNU12GQAA4	ARNU15GQAA4
Drain Pump	-	-
Cassette Cover	-	-
Refrigerant Leakage Detector	PRLDNV50	
EEV Kit	PRGK024A0	
Independent Power Module	PRIP0	
Robot Cleaner	-	-
Pre Filter (Washable)	○	
Ion Generator	○	
CO2 Sensor	-	-
Ventilation Kit	-	-
IR Receiver	-	-
Zone Controller	-	-
Dry Contact (with additional accessory)	PDRYCB000 (1 point contact), PDRYCB320 (Universal input), PDRYCB400 (2 points input), PDRYCB500 (Modbus)	
External Input (1 point)	○	
Wi-Fi	PWFMD200	

※ ○ : Applied, - : Not Applied
 Option: Refer to model name in table

**ARNU07GCEA4 / ARNU09GCEA4
ARNU12GCEA4 / ARNU15GCEA4
ARNU18GCEA4 / ARNU24GCEA4**



※ A : Floor Standing with case

MODEL	UNIT	ARNU07GCEA4	ARNU09GCEA4	ARNU12GCEA4	ARNU15GCEA4	ARNU18GCEA4	ARNU24GCEA4	
Cooling Capacity	kW	2.2	2.8	3.6	4.5	5.6	7.1	
Heating Capacity	kW	2.5	3.2	4.0	5.0	6.3	8.0	
Power Input (H / M / L)	Nominal W	24 / 17 / 14	30 / 24 / 17	36 / 30 / 24	44 / 35 / 28	54 / 41 / 29	84 / 54 / 41	
Exterior Color		Morning Fog	Morning Fog	Morning Fog	Morning Fog	Morning Fog	Morning Fog	
RAL Code		RAL 9001	RAL 9001	RAL 9001	RAL 9001	RAL 9001	RAL 9001	
Dimensions (W x H x D)	Body mm	1,067 x 635 x 203	1,067 x 635 x 203	1,067 x 635 x 203	1,067 x 635 x 203	1,345 x 635 x 203	1,345 x 635 x 203	
	Shipping mm	1,154 x 705 x 289	1,154 x 705 x 289	1,154 x 705 x 289	1,154 x 705 x 289	1,432 x 705 x 289	1,432 x 705 x 289	
Fan	Type	Sirocco Fan	Sirocco Fan	Sirocco Fan	Sirocco Fan	Sirocco Fan	Sirocco Fan	
	Motor Output x Number	W x No.	19 x 1, 5 x 1	19 x 1, 5 x 1	19 x 1, 5 x 1	19 x 1, 5 x 1	19 x 2	
	Air Flow Rate (H / M / L)	m ³ /min	8.5 / 7.5 / 6.5	9.5 / 8.5 / 7.5	10.5 / 9.5 / 8.5	11.5 / 10.0 / 9.5	16.0 / 14.0 / 12.0	18.0 / 16.0 / 14.0
	Motor Type		BLDC	BLDC	BLDC	BLDC	BLDC	
Air Filter		Pre Filter	Pre Filter	Pre Filter	Pre Filter	Pre Filter	Pre Filter	
	Liquid Side	mm (inch)	Ø6.35 (1/4)	Ø6.35 (1/4)	Ø6.35 (1/4)	Ø6.35 (1/4)	Ø9.52 (3/8)	
Pipe Connections	Gas Side	mm (inch)	Ø12.7 (1/2)	Ø12.7 (1/2)	Ø12.7 (1/2)	Ø12.7 (1/2)	Ø15.88 (5/8)	
	Drain Pipe (Internal Dia.)	mm (inch)	Ø12 (15/32)	Ø12 (15/32)	Ø12 (15/32)	Ø12 (15/32)	Ø12 (15/32)	
Weight	Body kg	27.0	27.0	27.0	27.0	34.0	34.0	
Sound Pressure Levels (H / M / L)	dB(A)	35 / 33 / 31	36 / 34 / 32	37 / 35 / 33	38 / 37 / 35	40 / 37 / 34	43 / 40 / 37	
Sound Power Levels (H / M / L)	dB(A)	52 / 47 / 43	54 / 51 / 47	54 / 51 / 50	55 / 54 / 51	57 / 54 / 50	61 / 57 / 54	
Power Supply	Ø, V, Hz	1, 220-240, 50	1, 220-240, 50	1, 220-240, 50	1, 220-240, 50	1, 220-240, 50	1, 220-240, 50	
Transmission Cable	mm ²	1.0 - 1.5 x 2C	1.0 - 1.5 x 2C	1.0 - 1.5 x 2C	1.0 - 1.5 x 2C	1.0 - 1.5 x 2C	1.0 - 1.5 x 2C	

Note:
 1. Performance tested under EN14511
 2. Capacities are based on the following conditions
 - Cooling : Indoor temp. 27°C (80.6°F) DB / 19°C (66.2°F) WB, Outdoor temp. 35°C (95°F) DB / 24°C (75.2°F) WB, Interconnecting piping length 7.5m, Level difference of zero
 - Heating : Indoor temp. 20°C (68°F) DB / 15°C (59°F) WB, Outdoor temp. 7°C (44.6°F) DB / 6°C (42.8°F) WB, Interconnecting piping length 7.5m, Level difference of zero
 3. Due to our policy of innovation, some specifications may be changed without notification

Accessories

CHASSIS	ARNU07GCEA4	ARNU09GCEA4	ARNU12GCEA4	ARNU15GCEA4	ARNU18GCEA4	ARNU24GCEA4
Drain Pump		-	-	-	-	-
Cassette Cover		-	-	-	-	-
Refrigerant Leakage Detector		PRLDNVSO			PRLDNVSO	
EEV Kit		PRGK024A0				
Independent Power Module		PRIPO			PRIPO	
Robot Cleaner		-	-	-	-	-
Pre Filter (Washable)		○			○	
Ion Generator		-	-	-	-	-
CO2 Sensor		-	-	-	-	-
Ventilation Kit		-	-	-	-	-
IR Receiver		PWLRVN000			PWLRVN000	
Zone Controller		-	-	-	-	-
Dry Contact (with additional accessory)		PDRYCB000 (1 point contact), PDRYCB320 (Universal input), PDRYCB400 (2 points input), PDRYCB500 (Modbus)				
External Input (1 point)		○			○	
Wi-Fi		PWFMD200			PWFMD200	

※ ○ : Applied, - : Not Applied
 Option: Refer to model name in table

**ARNU07GCEU4 / ARNU09GCEU4
ARNU12GCEU4 / ARNU15GCEU4
ARNU18GCEU4 / ARNU24GCEU4**



※ U : Floor Standing without case

MODEL	UNIT	ARNU07GCEU4	ARNU09GCEU4	ARNU12GCEU4	ARNU15GCEU4	ARNU18GCEU4	ARNU24GCEU4	
Cooling Capacity	kW	2.2	2.8	3.6	4.5	5.6	7.1	
Heating Capacity	kW	2.5	3.2	4.0	5.0	6.3	8.0	
Power Input (H / M / L)	Nominal W	24 / 17 / 14	30 / 24 / 17	36 / 30 / 24	44 / 35 / 28	54 / 41 / 29	84 / 54 / 41	
Dimensions (W x H x D)	Body mm	978 x 639 x 190	978 x 639 x 190	978 x 639 x 190	978 x 639 x 190	1,256 x 639 x 190	1,256 x 639 x 190	
	Shipping mm	1,055 x 702 x 260	1,055 x 702 x 260	1,055 x 702 x 260	1,055 x 702 x 260	1,333 x 702 x 260	1,333 x 702 x 260	
Fan	Type	Sirocco Fan	Sirocco Fan	Sirocco Fan	Sirocco Fan	Sirocco Fan	Sirocco Fan	
	Motor Output x Number	W x No.	19 x 1, 5 x 1	19 x 1, 5 x 1	19 x 1, 5 x 1	19 x 1, 5 x 1	19 x 2	
	Air Flow Rate (H / M / L)	m ³ /min	8.5 / 7.5 / 6.5	9.5 / 8.5 / 7.5	10.5 / 9.5 / 8.5	11.5 / 10.0 / 9.5	16.0 / 14.0 / 12.0	18.0 / 16.0 / 14.0
	Motor Type		BLDC	BLDC	BLDC	BLDC	BLDC	
Air Filter		Pre Filter	Pre Filter	Pre Filter	Pre Filter	Pre Filter	Pre Filter	
	Liquid Side	mm (inch)	Ø6.35 (1/4)	Ø6.35 (1/4)	Ø6.35 (1/4)	Ø6.35 (1/4)	Ø9.52 (3/8)	
Pipe Connections	Gas Side	mm (inch)	Ø12.7 (1/2)	Ø12.7 (1/2)	Ø12.7 (1/2)	Ø12.7 (1/2)	Ø15.88 (5/8)	
	Drain Pipe (Internal Dia.)	mm (inch)	Ø12 (15/32)	Ø12 (15/32)	Ø12 (15/32)	Ø12 (15/32)	Ø12 (15/32)	
Weight	Body kg	20.0	20.0	20.0	20.0	26.0	26.0	
Sound Pressure Levels (H / M / L)	dB(A)	35 / 33 / 31	36 / 34 / 32	37 / 35 / 33	38 / 37 / 35	40 / 37 / 34	43 / 40 / 37	
Sound Power Levels (H / M / L)	dB(A)	52 / 47 / 43	54 / 51 / 47	54 / 51 / 50	55 / 54 / 51	57 / 54 / 50	61 / 57 / 54	
Power Supply	Ø, V, Hz	1, 220-240, 50	1, 220-240, 50	1, 220-240, 50	1, 220-240, 50	1, 220-240, 50	1, 220-240, 50	
Transmission Cable	mm ²	1.0 - 1.5 x 2C	1.0 - 1.5 x 2C	1.0 - 1.5 x 2C	1.0 - 1.5 x 2C	1.0 - 1.5 x 2C	1.0 - 1.5 x 2C	

Note:
 1. Performance tested under EN14511
 2. Capacities are based on the following conditions
 - Cooling : Indoor temp. 27°C (80.6°F) DB / 19°C (66.2°F) WB, Outdoor temp. 35°C (95°F) DB / 24°C (75.2°F) WB, Interconnecting piping length 7.5m, Level difference of zero
 - Heating : Indoor temp. 20°C (68°F) DB / 15°C (59°F) WB, Outdoor temp. 7°C (44.6°F) DB / 6°C (42.8°F) WB, Interconnecting piping length 7.5m, Level difference of zero
 3. Due to our policy of innovation, some specifications may be changed without notification

Accessories

CHASSIS	ARNU07GCEU4	ARNU09GCEU4	ARNU12GCEU4	ARNU15GCEU4	ARNU18GCEU4	ARNU24GCEU4
Drain Pump		-	-	-	-	-
Cassette Cover		-	-	-	-	-
Refrigerant Leakage Detector		PRLDNVSO			PRLDNVSO	
EEV Kit		PRGK024A0				
Independent Power Module		PRIPO			PRIPO	
Robot Cleaner		-	-	-	-	-
Pre Filter (Washable)		○			○	
Ion Generator		-	-	-	-	-
CO2 Sensor		-	-	-	-	-
Ventilation Kit		-	-	-	-	-
IR Receiver		PWLRVN000			PWLRVN000	
Zone Controller		-	-	-	-	-
Dry Contact (with additional accessory)		PDRYCB000 (1 point contact), PDRYCB320 (Universal input), PDRYCB400 (2 points input), PDRYCB500 (Modbus)				
External Input (1 point)		○			○	
Wi-Fi		PWFMD200			PWFMD200	

※ ○ : Applied, - : Not Applied
 Option: Refer to model name in table

NO.	NEW FUNCTION NAME (4 TH GENERATION INDOOR)	FUNCTION DESCRIPTION	REQUIRED CONTROLLER		REMARKS
			WIRED REMOTE CONTROLLER	CENTRALIZED CONTROLLER	
1	Energy Monitoring (Accumulated Electric Energy Check)	Monitoring accumulated power consumption by Wired Remote Controller	○	○	* Necessary to install the PDI (Power Distribution Indicator) and central controller * Combined with Multi V Water S outdoor unit, this function is not available.
		Monitoring accumulated power consumption by Central Control Device / PDI	-	○	* Necessary to install the PDI (Power Distribution Indicator) * To make a report, central controller must be installed
2	2 Set Point	1) 2 set point control by Indoor and central controller 2) Synchronization function with remote control (Synchronization Setting and Monitoring)	○	○	* Wired remote controller and central controller must be installed * Combined with Multi V Water S outdoor unit, this function is not available.
3	Occupied / Unoccupied Scheduling Function (Sub Func. Enable)	1) Synchronization according to occupied / unoccupied by Indoor and Central control 2) Synchronization icon with remote controller (Synchronization Monitoring)	○	○	* Centralized control is able to when you combine only 4th generation indoor units (Use together with 2nd generation and 4th generation indoors, only wired remote controller is able to set this function as existing way) * Wired remote controller or central controller must be installed (Function can be activated using just one control device.) * Combined with Multi V Water S outdoor unit, this function is not available.
4	Group Control	Group Control can use Additional function	○	○	* Check more details in PDB (Product Data Book) * Central controller can create and control group.
5	Test Run (Heating)	Test run mode can be operated in cooling mode and heating mode for easy service	○	-	
6	Model Information Monitoring	Product Type / Indoor Type / Indoor capacity information can be monitored by remote controller	○	-	
7	Indoor unit address checking	Wired remote controller can check indoor unit address information	○	-	
8	Refrigerant Leakage Detection	Function error sign display when refrigerant leakage occurred	○	○	* Central controller has been installed, CH230 error code can be recognized (Old / New Same) * Without Central Controller, it is able to recognize with wired remote controller (CH230) * Combined with Multi V Water S outdoor unit, this function is not available. * Accessory PRLDNVSO must be separately ordered
9	Thermo On / Off range Setting (Cooling)	User can set cooling thermo on/off range with wired remote controller for prevention overcooling	○	-	* Thermo On / Off temperature setting (3 step)
10	Thermo On / Off range Setting (Heating)	User can set heating thermo on/off range with wired remote controller for prevention overheating. (4 Step)	○	-	* Thermo On / Off temperature setting (4 step)
11	Static Pressure 11 Step Control (Only for Ceiling Concealed Duct Type)	Depends on the installation environment, 4th generation Ceiling Concealed Duct can control the static pressure by 11 steps for providing comfortable environment	○	-	* Only applied in Ceiling Concealed Duct
12	1 point External Input (On / Off control)	Indoor unit can be controlled by external devices without purchasing Dry contact as an accessory (All 4th generation indoors)	○	-	* Simple On/Off control by Dry Contact at Indoor [Example of Contact port by product type] * 2 Way Cassette : CN-CC Port (Wired remote controller installation function mode 41 is required) * 1 Way / 4 Way Cassette / Ceiling Concealed Duct / Wall Mounted Unit / Console / FAU / Floor Standing (with case / without case) : CN-EXT Port
13	Filter Sign (Remaining Time)	The alarm activates when the filter needs to be cleaned, and the time remaining for cleaning is displayed on the screen.	○	○	* The alarm activates on the central controller, but the remaining time is not displayed.
14	Auto restart function Disable / Enable	After the power failure compensation, stand by at OFF mode Restore the operation for the status before the power off	○	-	
15	Indoor Humidity display	Monitoring indoor humidity Wired Remote Controller	○	○	* Available only with Multi V 5
16	Comfort Cooling setting	set the outdoor unit comfort cooling operation value	○	○	* Available only with Multi V 5
17	Smart Load Control setting	Change the outdoor unit's Smart Load Control stage value.	○	○	* Available only with Multi V 5
18	ODU Refrigerant Noise Reduction setting	set the outdoor unit's refrigerant noise reduction function	○	○	* Available only with Multi V 5
19	Low noise mode time setting	set the start and end time of the outdoor unit's low noise mode operation	○	○	* Available only with Multi V 5

Note : 1) No.1, 2, 3, 8 : Functions are available to use together with 4th generation Indoor units only. If used together 2nd generation indoor unit and 4th generation indoor unit functions will not be activate. Combined with MULTI V Water S outdoor unit this function is not available.
2) No. 4, 5, 6, 7, 9, 10, 11, 12, 13, 14 : If used together 2nd generation indoor unit and 4th generation indoor unit these functions will be activate only in 4th generation indoor
3) 2nd generation indoor unit : Ceiling & Floor Convertible Unit, Ceiling Suspended Unit, HYDRO KIT (Low Temp. / High Temp.), ERV DX (with Humidifier, without Humidifier), AHU Communication Kit

WIRED REMOTE CONTROLLER					CENTRALIZED CONTROLLER				
PREMIUM (PREMTA000 PREMTA000A PREMTA000B)	STANDARD III (PREMTB100) (PREMTB110)	STANDARD II (PREMTB001) (PREMTB001)	SIMPLE		AC EZ (PQCSZ250S0)	AC EZ TOUCH (PACEZA000)	AC SMART 5 (PACSSA000)	ACP 5 (PACPSA000)	AC MANAGER 5 (PACMSA000)
			SIMPLE FOR HOTEL (PQRCHCA0Q / QW)	SIMPLE (PQRCVCL0Q / QW)					
○	○	○	-	-	-	○	○	○	○
-	-	-	-	-	-	○	○	○	○
○	○	-	-	-	-	○	○	○	○
○	○	-	-	-	-	○	○	○	○
○	○	○	-	-	-	-	○	○	○
○	○	○	-	-	-	-	-	-	-
○	○	○	-	-	-	-	-	-	-
○	○	○	-	-	-	-	○	○	-
○	○	○	-	-	-	-	-	-	-
○	○	○	-	-	-	-	-	-	-
○	○	○	○	○	-	-	-	-	-
○ (4 step)	○ (4 step)	○ (3 step)	○ (3 step)	○ (3 step)	-	-	-	-	-
○	○	○	○	○	-	-	-	-	-
○	○	○	-	-	-	-	-	-	-
○	○	○	-	-	-	○	○	○	○
○	○	-	-	-	-	-	○	○	-
○	○	-	-	-	-	-	○	○	-
○	○	-	-	-	-	○	○	○	-

※ ○ : Applied, - : Not applied

Controller		Premium	Standard III	Standard II	Simple	Simple for Hotel	Wireless	Dry Contact						
		PREMTA000 PREMTA000A PREMTA000B	PREMTB10	PREMTB100	PREMTB01	PREMTB001	PQRCVCLQ	PQRCVCLQW	PQRCHAQ	PQRCHAQW	PWLSSB21H (H/P)	Simple Dry Contact PDRYCB000	2 points Dry Contact PDRYCB400	Dry Contact for Thermostat PDRYCB320
Ceiling Mounted Cassette	4 Way	ARNU-A4 ARNU-B4	○	○	○	○	○	○	○	○	○	○	○	○
	2 Way / 1 Way	ARNU-B4 ARNU-C4	○	○	○	○	○	○	○	○	○	○	○	○
	Round CST	ARNU-A4	○	○	○	○	○	○	○	○	○	○	○	○
Ceiling Concealed Duct	High Sensible	ARNU-A4	○	○	○	○	○	△	○	○	○	○	○	○
	High / Mid Statics	ARNU-A4	○	○	○	○	○	△	○	○	○	○	○	○
	Low Statics	ARNU-G4	○	○	○	○	○	△	○	○	○	○	○	○
FAU (Fresh Air intake)	ARNU-Z4	○	○	○	○	○	△	○	○	○	○	○	○	
Convertible & Ceiling Suspended	ARNU-A4	○	○	○	○	○	○	○	○	○	○	○	○	
MULTI V	Console	ARNU-A4	○	○	○	○	○	○	○	○	○	○	○	○
	Floor Standing	ARNU-A4	○	○	○	○	○	○	○	○	○	○	○	○
		ARNU-U4	○	○	○	○	○	○	○	○	○	○	○	○
Wall Mounted	ARNU-A4	○	○	○	○	○	○	○	○	○	○	○	○	
	ARNU-R4	○	○	○	○	○	○	○	○	○	○	○	○	
	ARNU-A4 ARNU-C4 ARNU-N4	○	○	○	○	○	○	○	○	○	○	○	○	
HYDRO KIT ¹⁾	ARNH-A4	-	-	-	-	-	-	○	-	○	-	-		
Ventilation	Energy Recovery Ventilator	○	○	○	-	-	-	○	-	-	-	○	-	
	Energy Recovery Ventilator with DX coil	○	○	○	-	-	-	○	-	-	-	-	○	
AHU Communication Kit	○	○	○	-	-	△	-	-	-	-	-	-		

※ ○ : Compatible, △ : Need wired remote controller / IR receiver, - : Not compatible
1) It has a separate remote controller

Controller Name	Wired Remote Controller					Wireless Remote Controller	Wi-Fi Modem
	Premium	Standard III	Standard II	Simple	Simple (Hotel)		
Model Name	PREMTA000 PREMTA000A PREMTA000B	PREMTB100 PREMTB10	PREMTB001 PREMTB01	PQRCVCLQ PQRCVCLQW	PQRCHAQ PQRCHAQW	PWLSSB21H (H/P)	PWFMD200
On / Off	○	○	○	○	○	○	○
Fan Speed Control	○	○	○	○	○	○	○
Temperature Setting	○	○	○	○	○	○	○
Mode Change	○	○	○	○	-	○	○
Auto Swing	○	○	○	○	○	○	○
Basic							
Vane Control (Louver Angle)	○	○	○	○	○	○	○
E.S.P (External Static Pressure)	○	○	○	○	○	-	-
Electric Failure Compensation	○	○	○	○	○	-	○
Indoor Temperature Display	○	○	○	○	○	○	-
ALL Button Lock (Child Lock)	○	○	○	○	○	-	-
Schedule / Timer	Weekly - Yearly	Weekly - Yearly	Weekly	-	-	Sleep / On / Off	Weekly
Additional Mode Setting ¹⁾	○	○	○	-	-	-	-
Time Display	○	○	○	-	-	○	-
Humid. Display	○	○	-	-	-	-	-
Advanced Lock (mode, set point, set point range, on/off Lock)	Advanced Lock	Advanced Lock	-	-	-	-	-
Advanced							
Filter Sign	○	○	○	-	-	-	-
Energy Management ²⁾	○	○	○	-	-	-	-
Dual Set Point	○	○	-	-	-	-	-
Human Detection	-	○	-	-	-	-	-
Temp, Humidity Compensation	○	○	-	-	-	-	-
Wi-Fi AP mode setting	○	○	○	○	○	○	-
Operation Status LED	○	○	○	○	○	-	-
Wireless Remote Controller Receiver	○ ³⁾	-	○ ³⁾	○ ³⁾	○ ³⁾	-	-
ETC							
Display	5 inch Color	4.3 inch Color	4.3 inch mono	2.6 inch mono	2.6 inch mono	2 inch mono	-
Size (W x H x D, mm)	137 x 121 x 16.5	120 x 120 x 16	120 x 121 x 16	70 x 121 x 16	70 x 121 x 16	51 x 153 x 26	48 x 68 x 14
Black Control for Screen Saver	○	○	-	-	-	-	-

※ ○ : Applied, - : Not Applied
1) It might not be indicated or operated at the partial product
2) Centralized control (PACEZA000 / PACSSA000 / PACPSA000 / PLNWK000) and PDI (PQNU1S40 / PPWRDB000) should be installed for this function
3) For ceiling type duct
Note
- Indoor unit should have functions requested by the controller
- If you need more detail, please refer to the manual of product. (<http://partner.lge.com>: Home > DocLibrary > Manual)

192 - 201

HOT WATER SOLUTION

HYDRO KIT

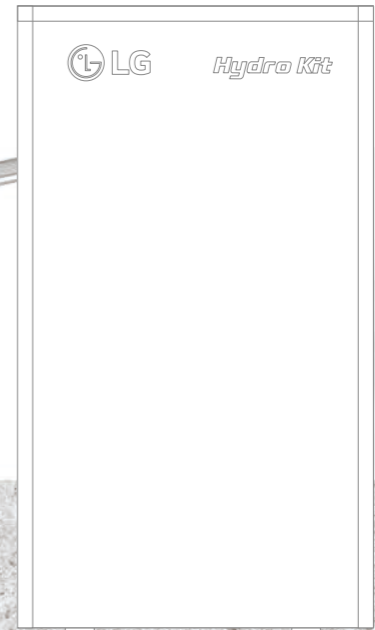
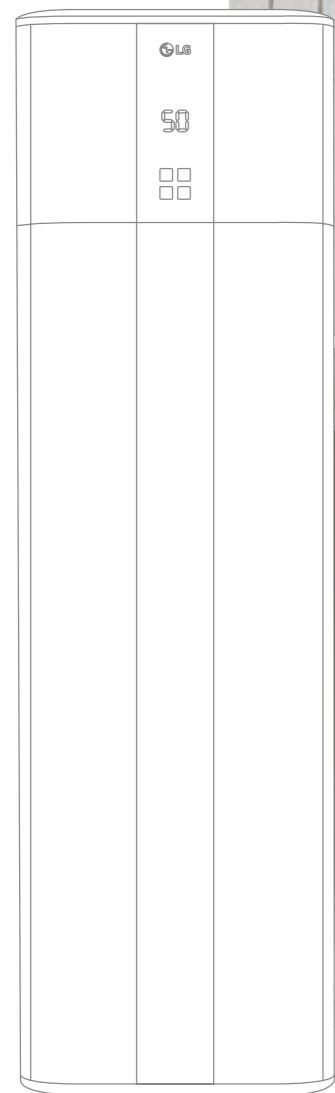

HYDRO KIT

Features & Benefits

- Lower operation cost compared to fossil fuel-based systems such as boilers.
- More energy saving through MULTI V heat recovery system.

Key Applications

- Where Hot Water is needed such as domestic Hot Water, In-floor or radiant heat. Where cold water is needed such as Fan coil unit and chilled beam.

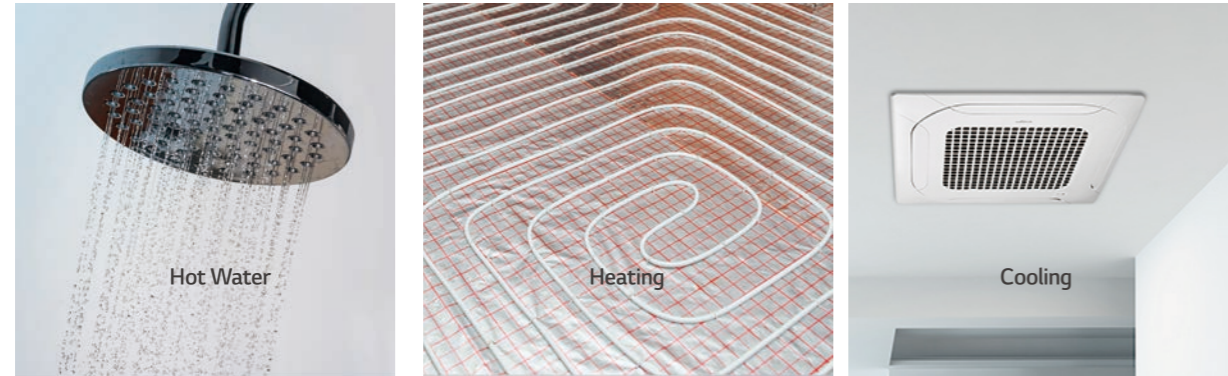

Radiant Heating / Cooling

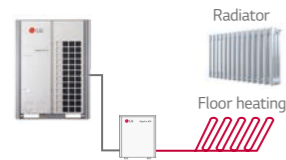

Fan Coil Unit Heating / Cooling

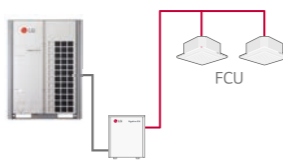

Hot Water / Cold Water

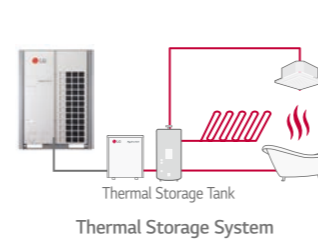
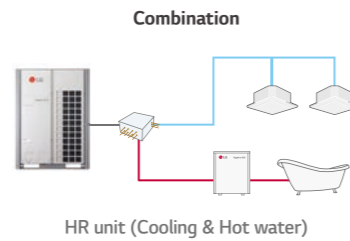
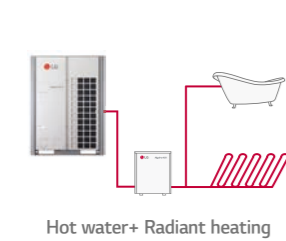
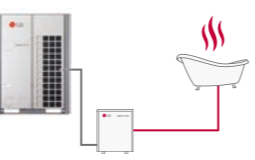

Eco-conscious Solution

Green energy solution through the reduction of CO₂ emissions.

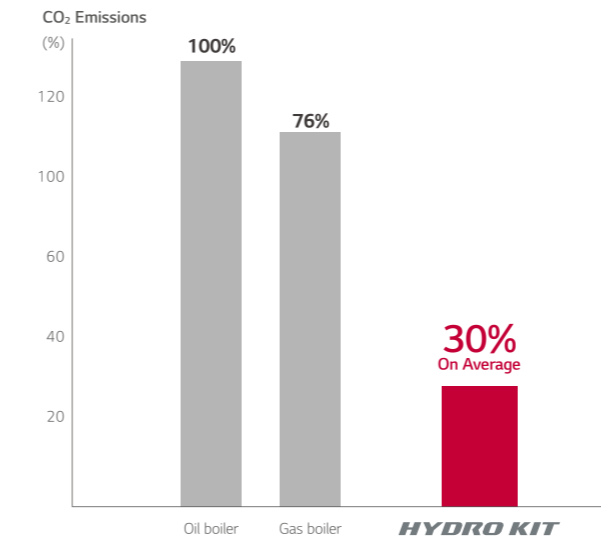

Space Saving

Wall mounted hydro kit with Multi V S outdoor is suitable for residential application with its compact size and design.

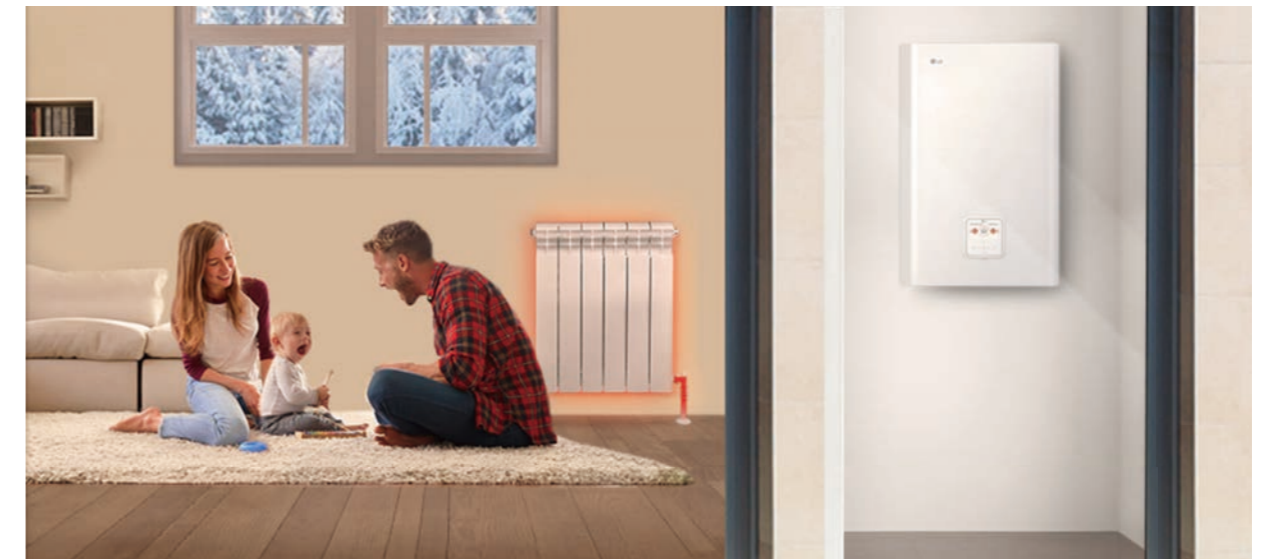

Total Solution

Total solution provided with heat pump, air conditioning (Cooling by refrigerant and cold water / heating by refrigerant hot water) and domestic hot water supply.

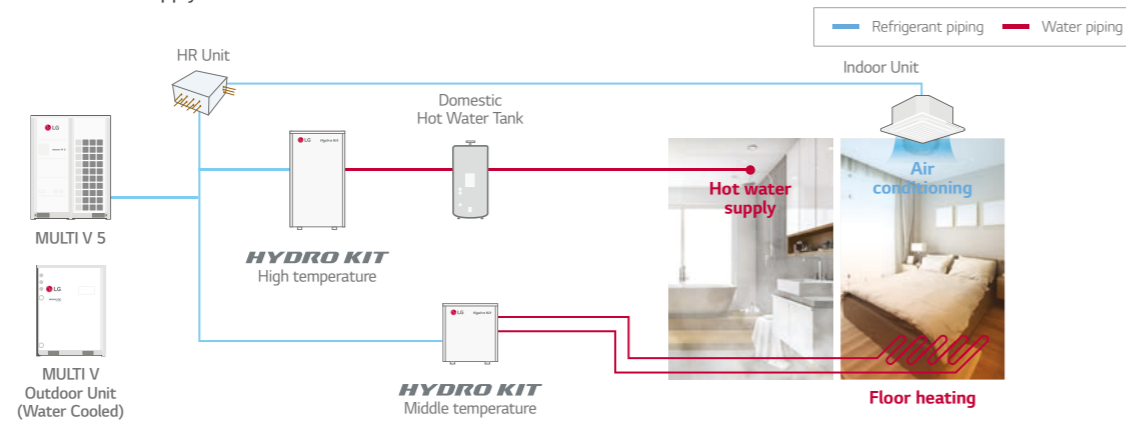

Compatible with compact R32 Multi V S

Product Volume (m³)

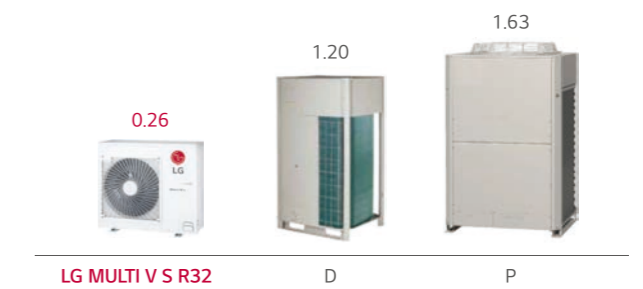

CONVENIENCE

CONVENIENCE

HOT WATER SOLUTION

HYDRO KIT

EFFICIENCY

Cost Savings with High Efficiency

Equivalent installation cost of traditional boiler with reduced operational costs.

1st Proposal MULTI V 5 HYDRO KIT

- (Air Conditioning + Hot Water Supply + Floor Heating)
- 2nd Proposal MULTI V 5 Air-Conditioning + Gas Boiler (Hot Water Supply + Floor Heating)
- 3rd Proposal MULTI V 5 Air-Conditioning + Oil Boiler (Hot Water Supply + Floor Heating)

Analysis Conditions

- Building Type : Dormitory, Flats
- Cooling / Floor Heating / Sanitary Hot Water for 10 years
- Cooling : MULTI V IV Indoor Unit
- Floor Heating : Medium Temp. HYDRO KIT (1ea)
- Sanitary Hot Water : High Temp. HYDRO KIT (2ea), Sanitary Hot Water Tanks
- Electricity Cost : Average Cost in EU
- Gas Cost : Average Cost in EU
- Oil Cost : Average Cost in EU

Initial Costs

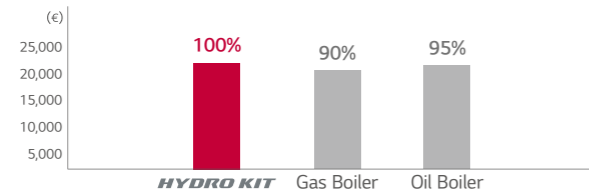

Annual Operating Costs

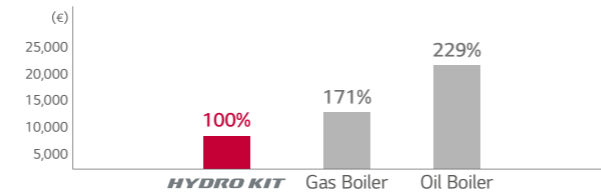

LCC

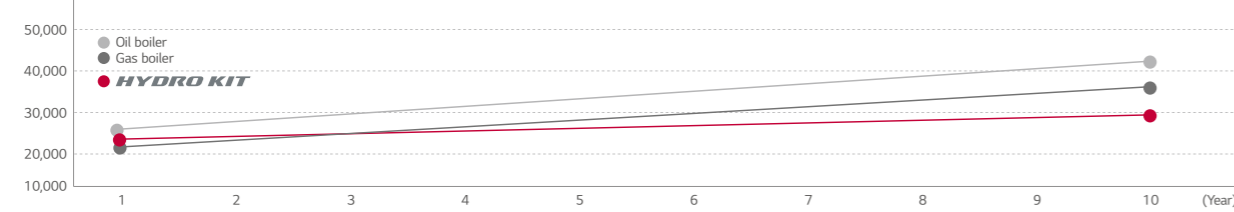

Energy Savings through Heat Recovery

Conventional

Absorbed heat is released to outdoor air.

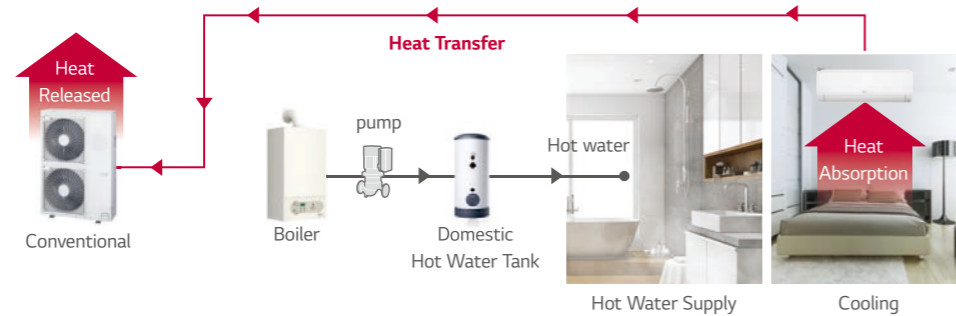

HYDRO KIT

Absorbed heat from indoor space is used for making hot water.

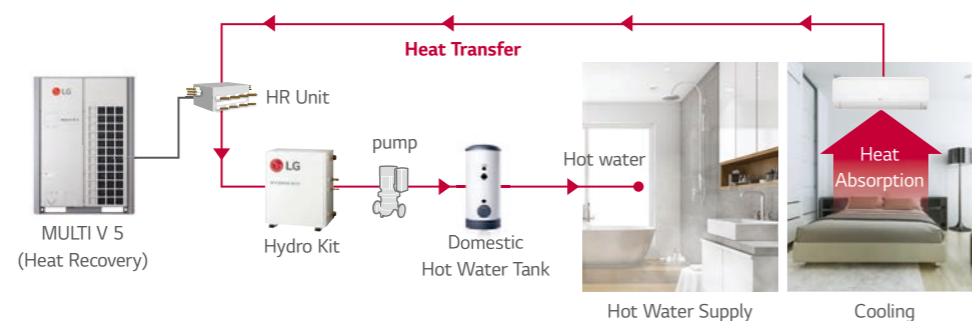

High Temperature HYDRO KIT Cycle Diagram

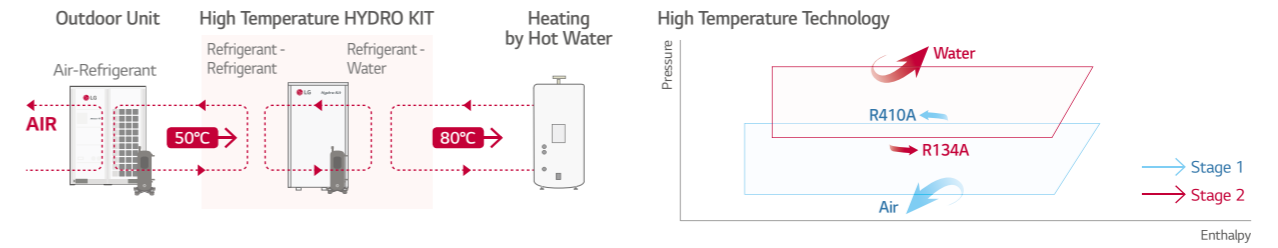

Various Applications

Applicable to a variety of facilities including hospitals, residences and resorts that need floor heating and domestic hot water supply.



Hotel Application

Constant simultaneous cooling and heating operation during summer to provide hot water by using wasted heat energy from indoor cooling process.

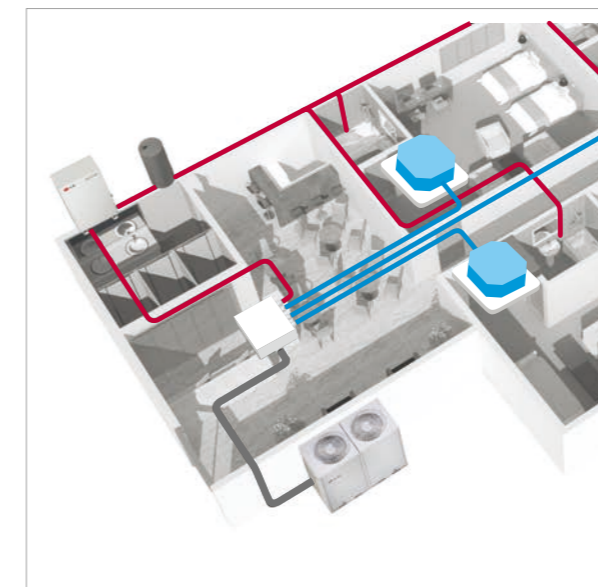

Office Application

Hot water can be supplied at all times in the office by cooling the HR unit to warm up the sanitary tank, using waste energy.

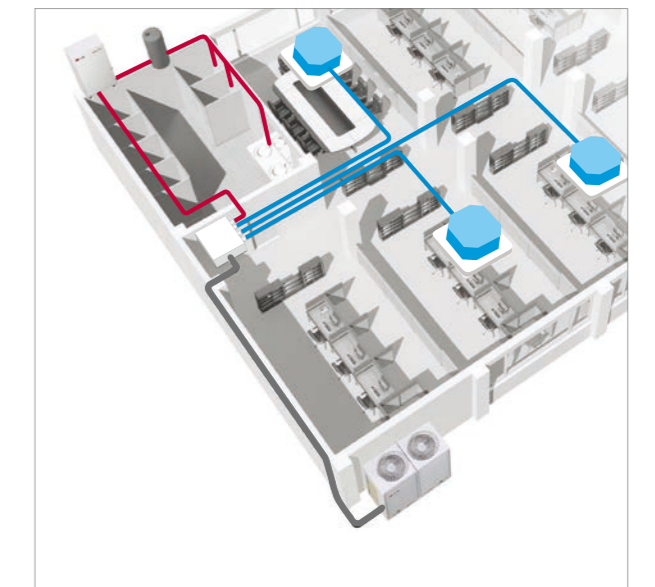

ARNH18GK1A4 / ARNH24GK1A4
ARNH30GK1A4

MODEL		UNIT	ARNH18GK1A4	ARNH24GK1A4	ARNH30GK1A4
Power Supply		V, Ø, Hz	220-230-240, 1, 50/60	220-230-240, 1, 50/60	220-230-240, 1, 50/60
Capacity (Rated)	Cooling	kW	5.6	7.1	9.0
		kcal/h	4,800	6,100	7,700
		Btu/h	19,100	24,200	30,700
	Heating	kW	5.6	7.1	9.0
		kcal/h	4,800	6,100	7,700
		Btu/h	19,100	24,200	30,700
Input (Rated)	Cooling	W	75	75	75
	Heating	W	75	75	75
Running Current (220 - 230 - 240V)		Cooling / Heating	A	0.70 - 0.67 - 0.64	0.70 - 0.67 - 0.64
Casing	Material	-	Painted Steel Plate	Painted Steel Plate	Painted Steel Plate
	RAL (Classic)	-	RAL 9003	RAL 9003	RAL 9003
Dimensions	Net(W x H x D)	mm	490 x 850 x 315	490 x 850 x 315	490 x 850 x 315
	Shipping(W x H x D)	mm	1,082 x 563 x 375	1,082 x 563 x 375	1,082 x 563 x 375
Weight	Net	kg	42.0	42.0	42.0
	Shipping	kg	47.0	42.0	42.0
Heat Exchanger	Refrigerant to Water	Type	-	Brazed Plate HEX	Brazed Plate HEX
		Quantity	EA	1	1
		Number of Plate	EA	54	54
		Water Volume	ℓ	0.7	0.7
		Rated Water Flow	ℓ/min	15.8	20.1
Head Loss		m	0.22	0.30	0.40
Water Pump	Type	-	Canned type for hot water circulation	Canned type for hot water circulation	Canned type for hot water circulation
	Model	-	GRUNDFOS UPM3K 20-75 CHBL	GRUNDFOS UPM3K 20-75 CHBL	GRUNDFOS UPM3K 20-75 CHBL
	Motor Type	-	AC Motor	AC Motor	AC Motor
	Steps of Pump Performance	-	Variable capacity 10% to 100%	Variable capacity 10% to 100%	Variable capacity 10% to 100%
	Power input	Min. - Max.	W	3 - 60	3 - 60
Expansion Vessel	Volume	Max.	ℓ	8.0	8.0
	Water pressure	Max.	bar	3.0	3.0
	Water pressure	Pre-charged	bar	1.0	1.0
Strainer	Mesh size	-	28 mesh	28 mesh	28 mesh
	Material	-	Stainless Steel	Stainless Steel	Stainless Steel
Relief valve	Pressure Limit	Upper Limit	bar	3.0	3.0



MODEL		UNIT	ARNH18GK1A4	ARNH24GK1A4	ARNH30GK1A4
Backup Heater	Type	-	Sheath	Sheath	Sheath
	Number of Heating Coil	EA	2	2	2
	Capacity Combination	kW	3.0 + 3.0	3.0 + 3.0	3.0 + 3.0
	Operation	-	Automatic	Automatic	Automatic
	Heating Steps	Step	2	2	2
	Power Supply	V, Ø, Hz	220-240, 1, 50	220-240, 1, 50	220-240, 1, 50
	FLA	A	31.0	31.0	31.0
	Power Cable (H07RN-F) (Included Earth)	mm ² x cores	4.0 x 3C	4.0 x 3C	4.0 x 3C
Flow Sensor	Type	-	Vortex	Vortex	Vortex
	Model	-	SIKA VVX20	SIKA VVX20	SIKA VVX20
	Measuring Range	Min. - Max.	ℓ/min	5 - 80	5 - 80
	Flow (Trigger Point)	Min.	ℓ/min	7.0	7.0
Temperature Control		-	Microprocessor, Thermostat for cooling and heating	Microprocessor, Thermostat for cooling and heating	Microprocessor, Thermostat for cooling and heating
Water Tank Temperature Sensor	Type(Sensor Holder)	-	Male PT 1/2 inch	Male PT 1/2 inch	Male PT 1/2 inch
	Length	m	12	12	12
Sound Absorbing Thermal Insulation Material		-	Foamed polystyrene	Foamed polystyrene	Foamed polystyrene
Safety Device		-	Fuse	Fuse	Fuse
Piping Connections	Water Side	Inlet	-	Male PT 1 inch	Male PT 1 inch
		Outlet	-	Male PT 1 inch	Male PT 1 inch
	Refrigerant Side	Liquid	mm(inch)	Ø 9.52(3/8)	Ø 9.52(3/8)
		Gas	mm(inch)	Ø 15.88(5/8)	Ø 15.88(5/8)
Power Cable Supply Cable (H07RN-F)		mm ² x cores	2.5 x 3C	2.5 x 3C	2.5 x 3C
Communication Cable (VCTF-SB)		mm ² x cores	1.0-1.5 x 2C	1.0-1.5 x 2C	1.0-1.5 x 2C
Refrigerant	Refrigerant to Water	Type	-	R32	R32
		Precharged Amount	kg (lbs)	-	-
		Additional Charging Amount	kg (each)	0.43	0.43
		Control	-	EEV	EEV
Sound Pressure Level	Cooling / Heating	Rated	dB(A)	35	35
Sound Power Level	Cooling / Heating	Rated	dB(A)	44	44

ARNH04GK2A4 / ARNH10GK2A4



MODEL		UNIT	ARNH04GK2A4	ARNH10GK2A4
Cooling Capacity		kW	12.3	28.0
Heating Capacity		kW	13.8	31.5
Power Input Nominal ¹⁾		W	10	10
Exterior Color			Morning Gray	Morning Gray
RAL Code			RAL 7030	RAL 7030
Dimensions (W x H x D)	Body	mm	520 x 631 x 330	520 x 631 x 330
	Shipping	mm	677 x 687 x 418	677 x 687 x 418
Pipe Connections	Liquid Side	mm (inch)	Ø9.52 (3/8)	Ø9.52 (3/8)
	Gas Side	mm (inch)	Ø15.88 (5/8)	Ø22.2 (7/8)
	Drain Pipe (Internal Dia.)	A (inch)	25A (Male PT 1)	25A (Male PT 1)
Water Pipe Connections	Inlet	A (inch)	25A (Male PT 1)	25A (Male PT 1)
	Outlet	A (inch)	25A (Male PT 1)	25A (Male PT 1)
Weight	Body	kg	29.2	33.7
Sound Pressure Levels (H / M / L)		dB(A)	26	26
Power Supply		Ø, V, Hz	1, 220-240, 50	1, 220-240, 50
Communication Cable		mm ² x No.	1.0 - 1.5 x 2C	1.0 - 1.5 x 2C

1) Nominal : Performance tested under EN14511

Note :

1. Capacities are based on the following conditions :

- Cooling : Indoor 27°C (80.6°F) DB / 19°C (66.2°F) WB, Outdoor 35°C (95°F) DB / 24°C (75.2°F) WB, Water Inlet 23°C (73.4°F) / Outlet 18°C (64.4°F)

- Heating : Indoor 20°C (68°F) DB / 15°C (59°F) WB, Outdoor 7°C (44.6°F) DB / 6°C (42.8°F) WB, Water Inlet 30°C (86°F) / Outlet 35°C (95°F)

2. Piping Length : Interconnected Pipe Length = 7.5m

3. Difference Limit of Elevation (Outdoor - Indoor Unit) is Zero.

4. MULTI V S 4HP (ARUN040GSS0, ARUN040LSS0) cannot be connected to Hydro Kit.

5. MULTI V Water S cannot be connected to Hydro Kit.

6. Anti freezing liquid should be added under 10°C (outdoor temp.) during cooling mode.

Accessories

CHASSIS	ARNH04GK2A4	ARNH10GK2A4
Drain Pump		-
Cassette Cover		-
Refrigerant Leakage Detector		PRLDNVSO
EEV Kit		-
Independent Power Module		○
Robot Cleaner		-
Pre Filter (Washable)		-
Ion Generator		-
CO ₂ Sensor		-
Ventilation Kit		-
IR Receiver		-
Zone Controller		-
Dry Contact (with additional accessory)		PDRYCB000 (1 point contact), PDRYCB320 (Universal input)
External Input (1 point)		○
Wi-Fi		PWFMD200

※ ○ : Applied, - : Not applied
Option : Refer to model name in table

ARNH04GK3A4 / ARNH08GK3A4



MODEL		UNIT	ARNH04GK3A4	ARNH08GK3A4
Heating Capacity		kW	13.8	25.2
Power Input Nominal ¹⁾		W	2,300	5,000
Exterior Color			Morning Gray	Morning Gray
RAL Code			RAL 7030	RAL 7030
Dimensions (W x H x D)	Body	mm	520 x 1,080 x 330	520 x 1,080 x 330
	Shipping	mm	682 x 1,168 x 423	682 x 1,168 x 423
Pipe Connections	Liquid Side	mm (inch)	Ø9.52 (3/8)	Ø9.52 (3/8)
	Gas Side	mm (inch)	Ø15.88 (5/8)	Ø19.05 (3/4)
	Drain Pipe (Internal Dia.)	A (inch)	25A (Male PT 1)	25A (Male PT 1)
Water Pipe Connections	Inlet	A (inch)	25A (Male PT 1)	25A (Male PT 1)
	Outlet	A (inch)	25A (Male PT 1)	25A (Male PT 1)
Weight	Body	kg	87.0	91.0
Sound Pressure Levels (H / M / L)		dB(A)	43	46
Power Supply		Ø, V, Hz	1, 220-240, 50	1, 220-240, 50
Communication Cable		mm ² x No.	1.0 - 1.5 x 2C	1.0 - 1.5 x 2C

1) Nominal : Performance tested under EN14511

Note :

1. Capacities are based on the following conditions :

- Heating : Indoor 20°C (68°F) DB / 15°C (59°F) WB, Outdoor 7°C (44.6°F) DB / 6°C (42.8°F) WB, Water Inlet 55°C (131°F) / Outlet 65°C (149°F)

2. Piping Length : Interconnected Pipe Length = 7.5m

3. Difference Limit of Elevation (Outdoor - Indoor Unit) is Zero.

4. MULTI V S 4HP (ARUN040GSS0, ARUN040LSS0) cannot be connected to Hydro Kit.

5. MULTI V Water S cannot be connected to Hydro Kit.

Accessories

CHASSIS	ARNH04GK3A4	ARNH08GK3A4
Drain Pump		-
Cassette Cover		-
Refrigerant Leakage Detector		PRLDNVSO
EEV Kit		-
Independent Power Module		○
Robot Cleaner		-
Pre Filter (Washable)		-
Ion Generator		-
CO ₂ Sensor		-
Ventilation Kit		-
IR Receiver		-
Zone Controller		-
Dry Contact (with additional accessory)		PDRYCB000 (1 point contact), PDRYCB320 (Universal input)
External Input (1 point)		○
Wi-Fi		PWFMD200

※ ○ : Applied, - : Not applied
Option : Refer to model name in table

202-213

VENTILATION SOLUTIONS

ERV / ERV WITH DX COIL





High Efficiency Heat Exchanger

Efficiency and comfort is ensured through the high-efficiency energy recovery central core which recovers energy from the indoor air and transfers it to the fresh incoming air without mixing the air stream.

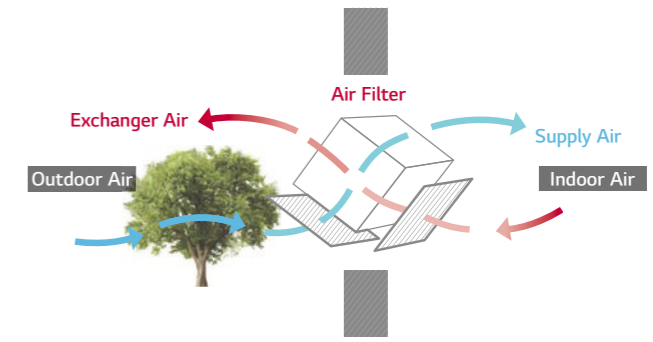

Exhaust System

The exhaust system uses a high static sirocco fan to effectively remove contaminants from indoor air. Supply and exhaust air flows are completely separated in the heat exchanger, allowing the LG ERV to filter out impurities before supplying outdoor air to ensure indoor air is fresh and healthy.

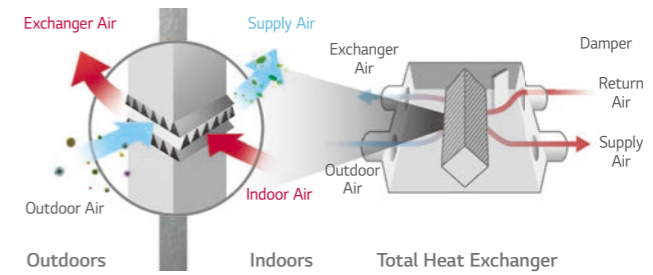

Night Time Free Cooling

During summer nights, indoor heat can be discharged outdoors and cool outdoor air can be brought indoors for energy savings.

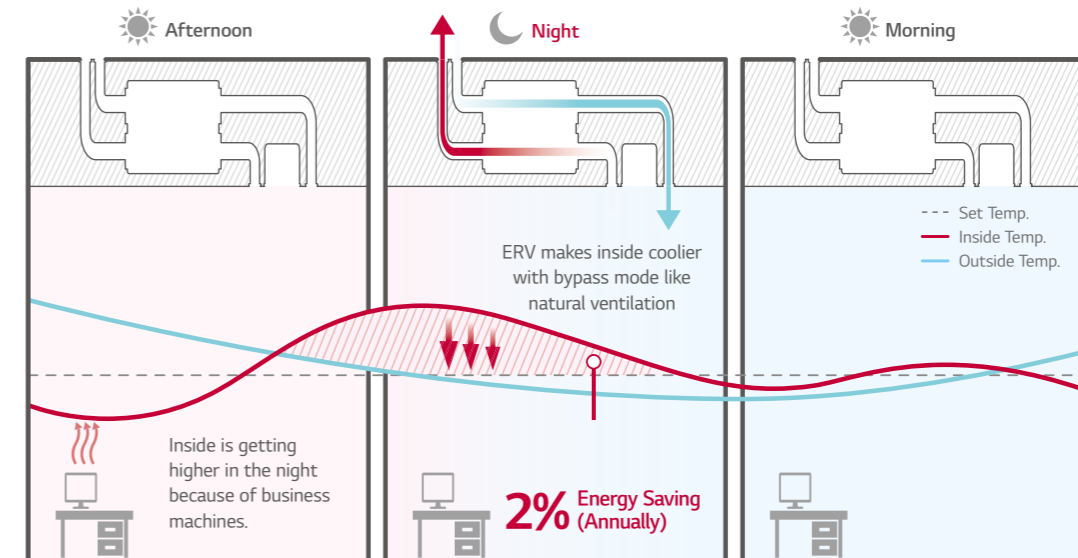

Necessity of ERV

Energy Recovery Ventilation (ERV)

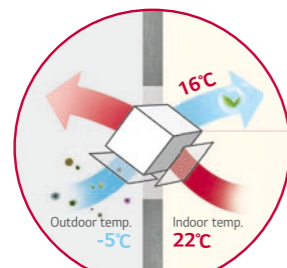

Comfort air + Energy Saving
Compare to natural ventilation
Heat exchanger collects wasted energy while ventilating.

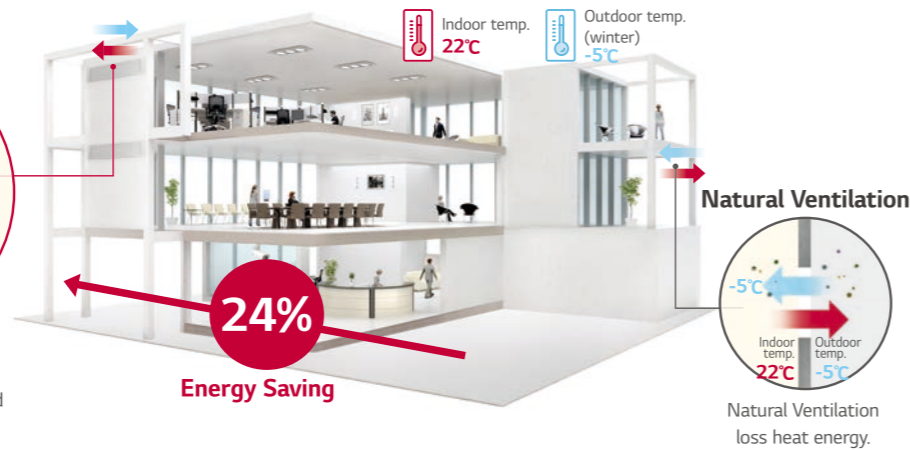

CO₂ Auto Operation

LG ERV reduces energy loss with auto fan speed control following CO₂ level.

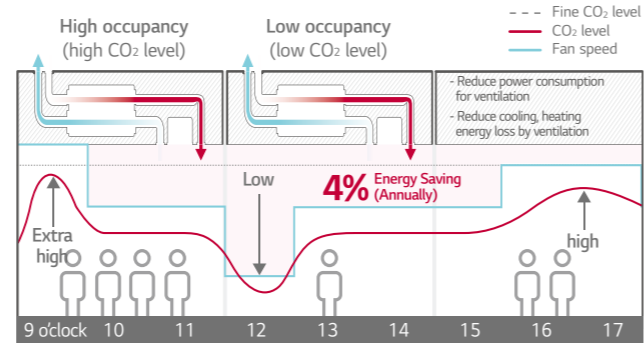

※ This function is operated with 'Night Time Free Cooling' on remote controller (with MULTI V only)
 ※ Energy saving ratio can be differed by weather condition.
 ※ Test Condition - Office (49,000ft²) / Occupancy : 30 / Area : London, UK
 - ERV (1000 CMH) + MULTI V 4 (12HP) Unit Combination
 - Other conditions are subject to BREEAM

Seasonal Auto Operation

LG ERV senses outdoor temperature and operates automatically following weather conditions.

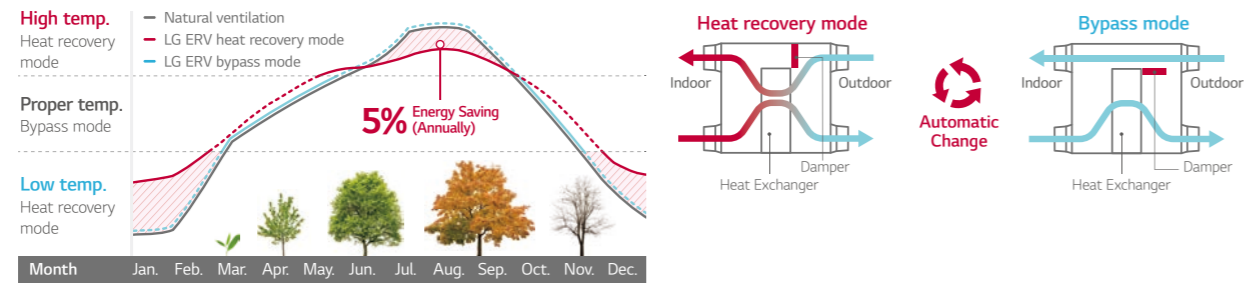

※ This function is operated with 'Auto' mode by wired remote control.
 ※ Energy saving ratio can be differed by weather condition.
 ※ Test Condition - Office (49,000ft²) / Occupancy : 30 / Area : London, UK
 - ERV (1,000 CMH) + MULTI V 4 (12HP) Unit Combination
 - Other conditions are subject to BREEAM

Delay Operation

When the air conditioner and ERV are switched on simultaneously, delay operation can reduce unnecessary heating and cooling energy loss by slowing down automatic ERV operation.

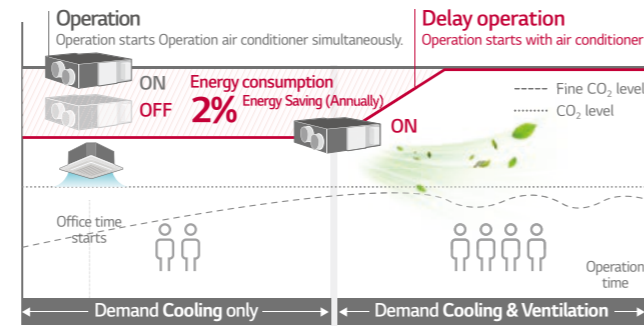

※ This function is operated with 'Night Time Free Cooling' on remote controller (with MULTI V only)
 ※ Energy saving ratio can be differed by weather condition.
 ※ Test Condition - Office (49,000ft²) / Occupancy : 30 / Area : London, UK
 - ERV (1000 CMH) + MULTI V 4 (12HP) Unit Combination
 - Other conditions are subject to BREEAM

CO₂ Level Monitoring

CO₂ sensor senses CO₂ level in the room. Users can monitor CO₂ level on new wired remote controller, and ERV controls the fan speed automatically following the level.

CO₂ Level Visualization

CO₂ sensor senses indoor CO₂ level and displays it on new wired remote controller.



Main display

If the CO₂ level is above 900ppm in the room, the red mark is on.

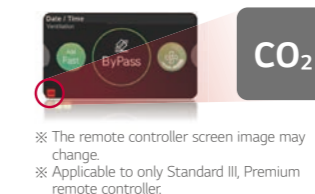

Further information

CO₂ level and room condition are displayed continuously.

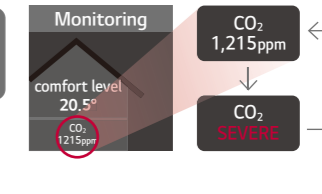

CO₂ Concentration Control

Using CO₂ sensor, LG ERV controls exhaust air flow automatically to keep indoor air fresh under settled CO₂ concentration.

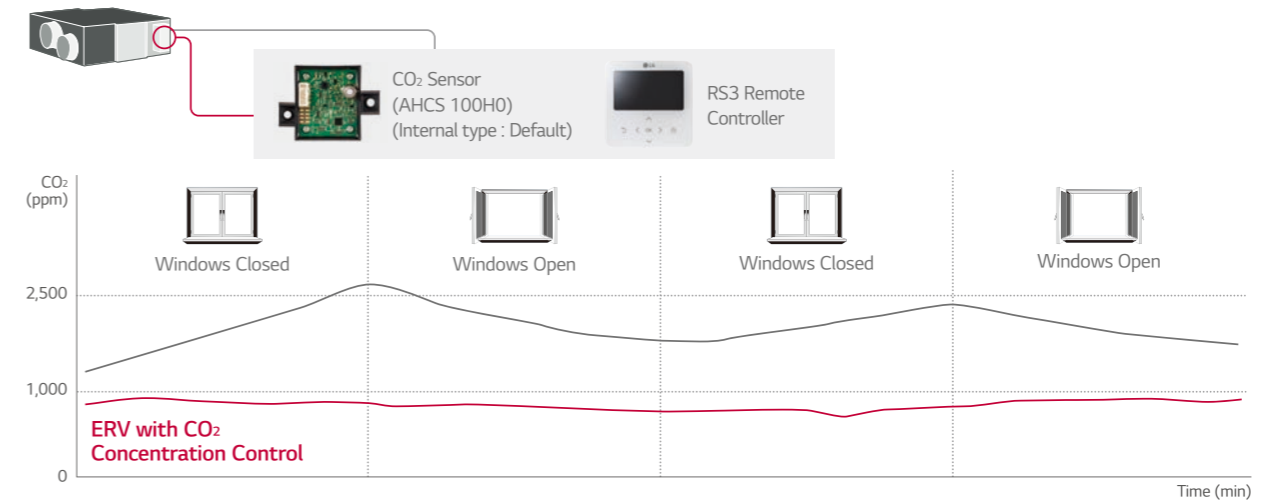

High Durability

LG ERV durability is increased through bacteria-resistant material of heat exchanger and corrosion protection coating. It prevents shortening of product life due to corrosion or mold, and supplies high quality air inside by minimizing bacteria.

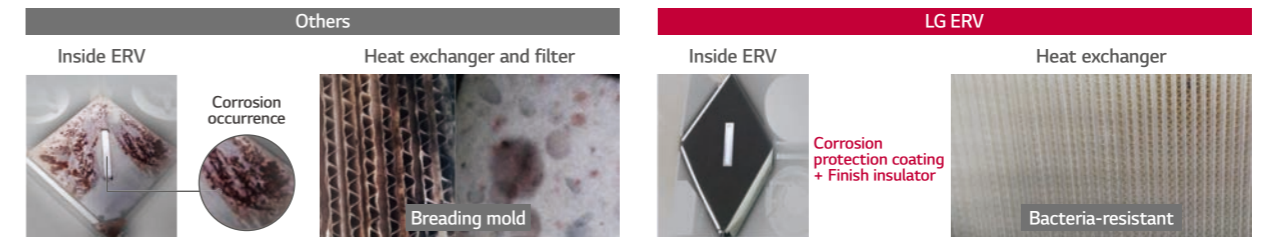

Easy Control

Wired remote controller is easy for usage.

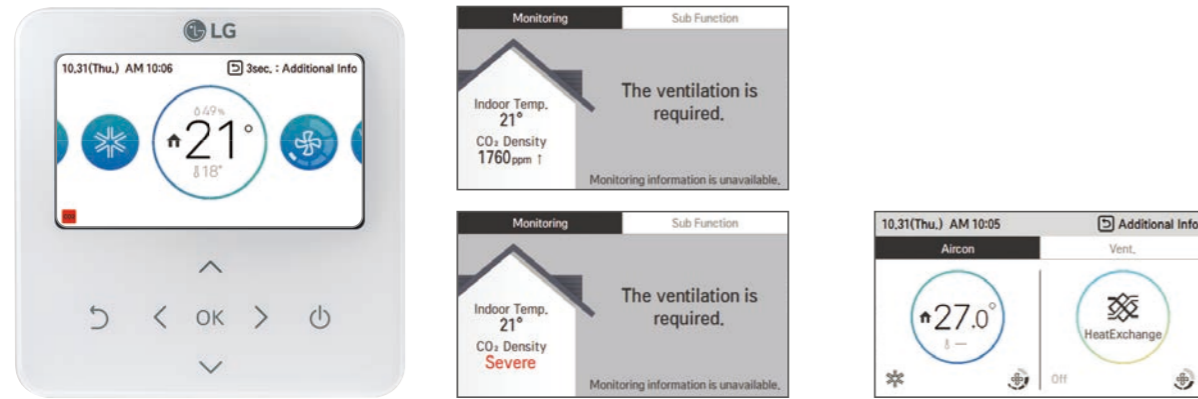

Easy

- Navigation buttons, easy to use.
- Easy installation setting

Visible

- Indoor CO₂ level
- Alarm for filter change / remaining time to change filters

Convenient

- Flexible display
- Dual display with air conditioner
- Zoom selected directory to increase legibility

Group Control

1 wired remote controller up to 16 ERV (Including air conditioner). It is convenient for large common space such as lobby.

Several units combination

16 units group control is available with 1 remote controller.

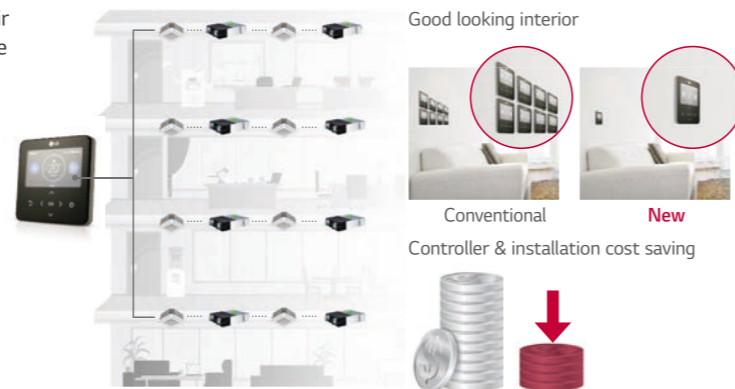

Interlocking with Air Conditioning System

- LG ERV can be interlocked with air conditioners and controlled individually.
- This function can be operated when the system is connected with 1 remote controller.

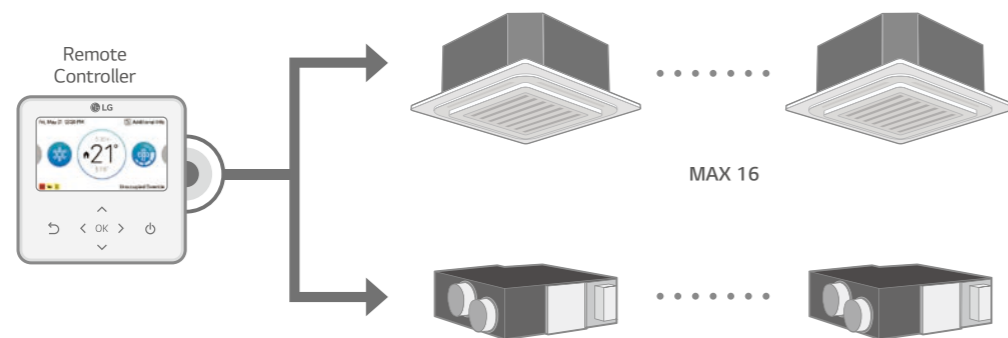

Fast Ventilation Mode

Fast ventilation mode prevents the spread of contaminants under negative indoor pressure, and makes indoor air fresh and comfortable quickly.

Only Exhausting

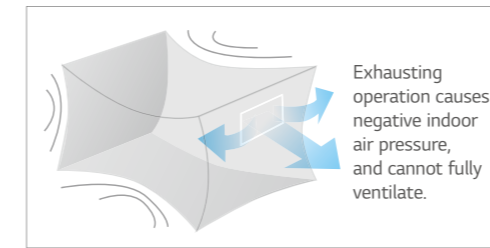

Exhausting and Supplying Simultaneously

Fast Ventilation Mode

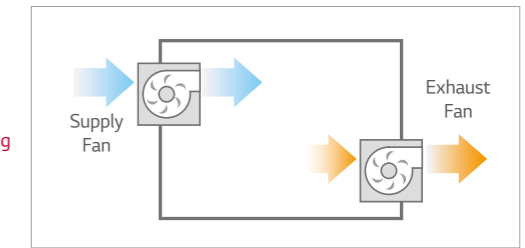

External Static Pressure Control

The high static pressure fan can control the air volume depending on the length of the duct. It is also easy to control the pressure level by using the remote controller for a more flexible duct installation and easier testing.

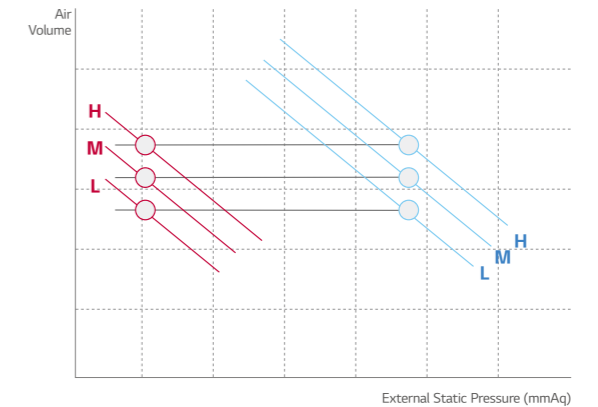

Easy Cleaning and Filter Change

Filter can be conveniently changed and cleaned.

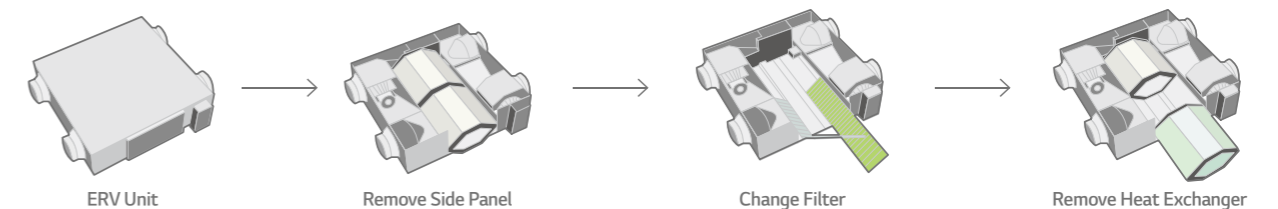

LZ-H025GBA4 / LZ-H035GBA5
LZ-H050GBA5



MODEL		UNIT	LZ-H025GBA4	LZ-H035GBA5	LZ-H050GBA5
Dimensions (W x H x D)	Body	mm	988 x 273 x 1,014		
	Weight	kg	44		
Power Supply		Ø, V, Hz	1, 220-240, 50		
Normal Air flow		m³/h	250	350	500
ERV Mode	Operating Step		Super-high / High / Low		
	Current	SH / H / L A	0.70 / 0.60 / 0.42	1.05 / 0.90 / 0.50	1.65 / 1.56 / 0.80
	Power Input	SH / H / L W	97 / 87 / 52	150 / 125 / 60	247 / 230 / 95
	Air Flow	SH / H / L m³/h	250 / 250 / 150	350 / 350 / 210	500 / 500 / 320
	External Static Pressure	SH / H / L Pa	100 / 70 / 50	150 / 100 / 50	150 / 100 / 50
	Temperature Exchange Efficiency	SH / H / L %	80 / 80 / 83	80 / 80 / 82	79 / 79 / 82
	Enthalpy Exchange Efficiency	Heating (SH / H / L) %	70 / 70 / 72	75 / 75 / 80	75 / 75 / 78
		Cooling (SH / H / L) %	66 / 66 / 68	71 / 71 / 75	68 / 68 / 75
	Energy Label	A+ to G Scale	A	B	B
	Sound Pressure Level	SH / H / L dB(A)	29 / 28 / 24	35 / 32 / 26	37 / 36 / 28
	Sound Power Level	SH / H / L dB(A)	50	53 / 50 / 42	57 / 56 / 46
	Bypass Mode	Operating Step		Super-high / High / Low	
Current		SH / H / L A	0.70 / 0.60 / 0.42	1.05 / 0.90 / 0.50	1.65 / 1.56 / 0.80
Power Input		SH / H / L W	97 / 87 / 52	150 / 125 / 60	247 / 230 / 95
Air Flow		SH / H / L m³/h	250 / 250 / 150	350 / 350 / 210	500 / 500 / 320
External Static Pressure		SH / H / L Pa	100 / 70 / 50	150 / 100 / 50	150 / 100 / 50
Sound Pressure Level		SH / H / L dB(A)	29 / 29 / 25	35 / 33 / 26	37 / 37 / 28
Duct Work	Qty	EA	4		
	Size (Ø)	mm	Ø200		
Supply Air Fan	Qty	EA	1		
	Type		Direct-Drive Sirocco		
Exhaust Air Fan	Qty	EA	1		
	Type		Direct-Drive Sirocco		
Filters	Qty	EA	2		
	Type		Cleanable fibrous fleeces		
	Size (W x H x D)	mm	855 x 10 x 166		

- Note :
- ERV mode : Total Heat Recovery Ventilation mode
 - Refer to dimensional drawings.
 - Noise level :
 - The operating conditions are assumed to be standard
 - Sound measured at 1.5m below the center the body.
 - Sound level will vary depending on a range of factors such as the construction(acoustic absorption coefficient) of particular room in which the equipment is installed.
 - The sound level at the air discharge port is about 8 dB(A) higher than the unit's operating sound.
 - Temperature and Enthalpy Exchange Efficiency at cooling Indoor Temperature : 26.5°C DB, 64.5% RH, Outdoor Temperature : 34.5°C DB, 75% RH
 - Temperature and Enthalpy Exchange Efficiency at heating Indoor Temperature : 20.5°C DB, 59.5% RH, Outdoor Temperature : 5°C DB, 65% RH
 - Temperature Exchange efficiency is tested at heating condition.

Accessories

CHASSIS	LZ-H025GBA4	LZ-H035GBA5	LZ-H050GBA5
Drain Pump		-	-
Cassette Cover		-	-
Refrigerant Leakage Detector		-	-
EEV Kit		-	-
Independent Power Module		-	-
Robot Cleaner		-	-
Pre Filter (Washable)		-	-
Ion Generator		-	-
CO ₂ Sensor		○	-
Ventilation Kit		-	-
IR Receiver		-	-
Zone Controller		-	-
Dry Contact (with additional accessory)		PDRYCB000 (1 point contact), PDRYCB500 (Modbus)	
External Input (1 point)		-	-
Wi-Fi		-	-

※ ○ : Applied, - : Not applied
Option : Refer to model name in table

LZ-H080GBA5 / LZ-H100GBA5
LZ-H150GBA5 / LZ-H200GBA5



MODEL		UNIT	LZ-H080GBA5	LZ-H100GBA5	LZ-H150GBA5	LZ-H200GBA5	
Dimensions (W x H x D)	Body	mm	1,101 x 405 x 1,230		1,353 x 815 x 1,230		
	Weight	kg	63		130		
Power Supply		Ø, V, Hz	1, 220-240, 50				
Normal Air flow		m³/h	800	1,000	1,500	2,000	
ERV Mode	Operating Step		Super-high / High / Low		Super-high / High / Low		
	Current	SH / H / L A	2.13 / 1.75 / 1.00	2.92 / 2.38 / 1.40	4.26 / 3.50 / 2.00	5.92 / 4.76 / 2.80	
	Power Input	SH / H / L W	328 / 266 / 144	463 / 370 / 208	660 / 530 / 290	926 / 740 / 420	
	Air Flow	SH / H / L m³/h	800 / 800 / 660	1,000 / 1,000 / 800	1,500 / 1,500 / 1,200	2,000 / 2,000 / 1,600	
	External Static Pressure	SH / H / L Pa	160 / 100 / 50	160 / 100 / 50	160 / 100 / 50	160 / 100 / 50	
	Temperature Exchange Efficiency	SH / H / L %	82 / 82 / 83	80 / 80 / 81	82 / 82 / 83	80 / 80 / 81	
	Enthalpy Exchange Efficiency	Heating (SH / H / L) %	73 / 73 / 76	71 / 71 / 73	73 / 73 / 76	71 / 71 / 73	
		Cooling (SH / H / L) %	66 / 66 / 70	64 / 64 / 67	66 / 66 / 70	64 / 64 / 67	
	Sound Pressure Level	SH / H / L dB(A)	40 / 36 / 32	40 / 37 / 33	43 / 39 / 35	43 / 40 / 36	
	Sound Power Level	SH / H / L dB(A)	56 / 53 / 47	59 / 56 / 52	59 / 56 / 50	62 / 59 / 55	
	Bypass Mode	Operating Step		Super-high / High / Low		Super-high / High / Low	
		Current	SH / H / L A	2.13 / 1.75 / 1.00	2.92 / 2.38 / 1.40	4.26 / 3.50 / 2.00	5.92 / 4.76 / 2.80
Power Input		SH / H / L W	328 / 266 / 144	463 / 370 / 208	660 / 530 / 290	926 / 740 / 420	
Air Flow		SH / H / L m³/h	800 / 800 / 660	1,000 / 1,000 / 800	1,500 / 1,500 / 1,200	2,000 / 2,000 / 1,600	
External Static Pressure		SH / H / L Pa	160 / 100 / 50	160 / 100 / 50	160 / 100 / 50	160 / 100 / 50	
Sound Pressure Level		SH / H / L dB(A)	41 / 37 / 33	41 / 38 / 34	44 / 40 / 36	44 / 41 / 37	
Duct Work	Qty	EA	4		4 + 2		
	Size (Ø)	mm	Ø250		Ø250 + Ø350		
Supply Air Fan	Qty	EA	1		2		
	Type		Direct-Drive Sirocco		Direct-Drive Sirocco		
Exhaust Air Fan	Qty	EA	1		2		
	Type		Direct-Drive Sirocco		Direct-Drive Sirocco		
Filters	Qty	EA	2		4		
	Type		Cleanable fibrous fleeces		Cleanable fibrous fleeces		
	Size (W x H x D)	mm	1,148 x 6 x 245		1,148 x 6 x 245		

- Note :
- ERV mode : Total Heat Recovery Ventilation mode
 - Refer to dimensional drawings.
 - Noise level :
 - The operating conditions are assumed to be standard
 - Sound measured at 1.5m below the center the body.
 - Sound level will vary depending on a range of factors such as the construction(acoustic absorption coefficient) of particular room in which the equipment is installed.
 - The sound level at the air discharge port is about 8 dB(A) higher than the unit's operating sound.
 - Temperature and Enthalpy Exchange Efficiency at cooling Indoor Temperature : 26.5°C DB, 64.5% RH, Outdoor Temperature : 34.5°C DB, 75% RH
 - Temperature and Enthalpy Exchange Efficiency at heating Indoor Temperature : 20.5°C DB, 59.5% RH, Outdoor Temperature : 5°C DB, 65% RH
 - Temperature Exchange efficiency is tested at heating condition.

Accessories

CHASSIS	LZ-H080GBA5	LZ-H100GBA5	LZ-H150GBA5	LZ-H200GBA5
Drain Pump		-	-	-
Cassette Cover		-	-	-
Refrigerant Leakage Detector		-	-	-
EEV Kit		-	-	-
Independent Power Module		-	-	-
Robot Cleaner		-	-	-
Pre Filter (Washable)		-	-	-
Ion Generator		-	-	-
CO ₂ Sensor			○	-
Ventilation Kit		-	-	-
IR Receiver		-	-	-
Zone Controller		-	-	-
Dry Contact (with additional accessory)		PDRYCB000 (1 point contact), PDRYCB500 (Modbus)		
External Input (1 point)		-	-	-
Wi-Fi		-	-	-

※ ○ : Applied, - : Not applied
Option : Refer to model name in table

Providing Cool & Warm Fresh Air

During the summer, ERV DX can transform outdoor warm air into cool air for indoors, and it can prevent cold draft during the winter by supplying warm air.

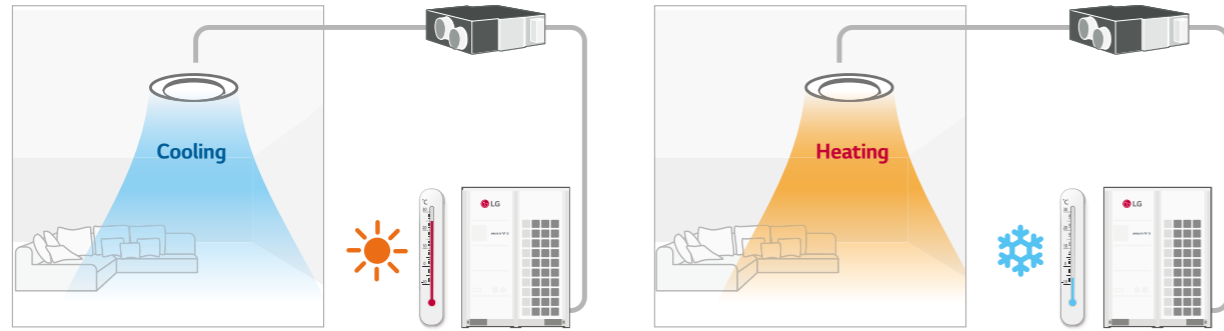

Total Air Conditioning Solution

LG ERV DX can be used as a Total Air Conditioning Solution. It can control condition of incoming air with the DX coil and humidifier for making comfortable indoor air. In the summer, LG ERV DX provides air conditioning by cooling and dehumidifying incoming air. During winter, warm air is provided by heating and humidifying incoming air.

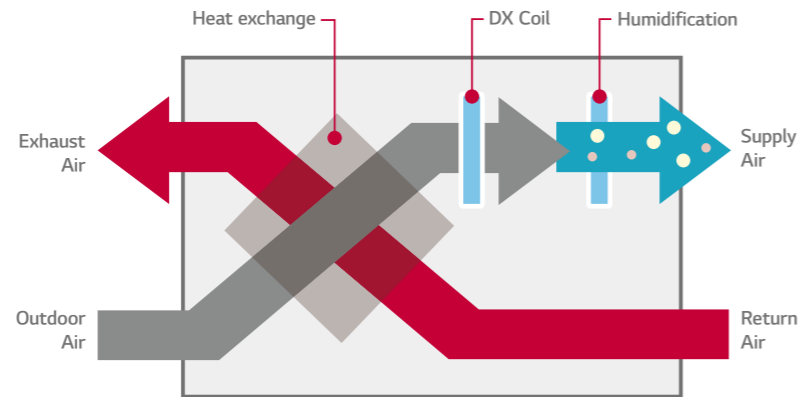

Interlocking with MULTI V

LG ERV DX can be interlocked with MULTI V. It can be controlled individually by a wired remote controller connected to MULTI V indoor units.

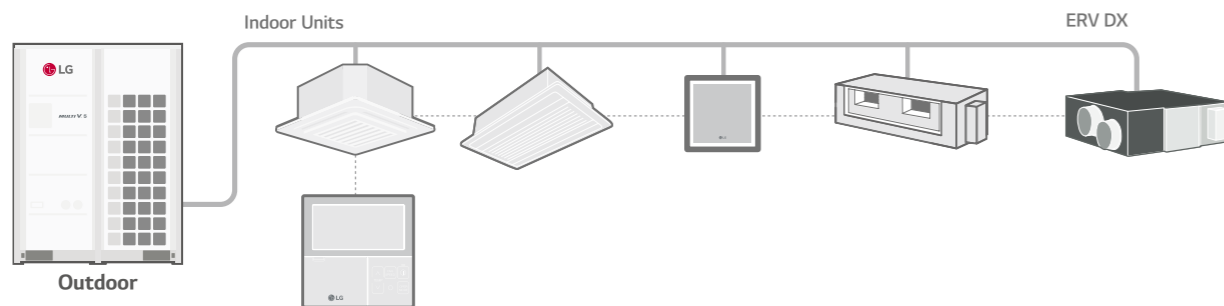

LZ-H050GXH4 / LZ-H080GXH4
LZ-H100GXH4 / LZ-H050GXN4
LZ-H080GXN4 / LZ-H100GXN4



MODEL		LZ-H050GXH4	LZ-H080GXH4	LZ-H100GXH4	LZ-H050GXN4	LZ-H080GXN4	LZ-H100GXN4
Fresh Air	Cooling	kW	4.93	7.46	9.12	4.93	7.46
Conditioning Load	Heating	kW	6.73	9.80	11.72	6.73	9.80
Temperature Exchange Efficiency	SH / H / L	%	86 / 86 / 87	80 / 80 / 81	76 / 76 / 78	86 / 86 / 87	80 / 80 / 81
Enthalpy Exchange Efficiency	Cooling (SH / H / L)	%	61 / 61 / 63	50 / 50 / 53	45 / 45 / 50	61 / 61 / 63	50 / 50 / 53
	Heating (SH / H / L)	%	76 / 76 / 77	67 / 67 / 69	64 / 64 / 66	76 / 76 / 77	67 / 67 / 69
Operation Range	Outdoor air Temperature	°C	-15 - 45	-15 - 45	-15 - 45	-15 - 45	-15 - 45
Air Flow Rate	Heat Exchange Mode (SH / H / L)	CMH	500 / 500 / 440	800 / 800 / 640	1,000 / 1,000 / 820	500 / 500 / 440	800 / 800 / 640
	Bypass Mode (SH / H / L)	CMH	500 / 500 / 440	800 / 800 / 640	1,000 / 1,000 / 820	500 / 500 / 440	800 / 800 / 640
Fan	External Static Pressure (SH / H / L)	Pa	160 / 120 / 100	140 / 90 / 70	110 / 70 / 60	180 / 150 / 110	170 / 120 / 80
	System		Natural Evaporating Type				
Humidifier	Amount	kg/h	2.70	4.00	5.40		
	Pressure Feed Water	Mpa	0.02 - 0.49				
Sound Pressure	Heat Exchange Mode (SH / H / L)	dB(A)	38 / 36 / 33	39 / 37 / 34	40 / 38 / 35	39 / 37 / 35	41 / 38 / 36
	Bypass Mode (SH / H / L)	dB(A)	39 / 37 / 34	40 / 38 / 35	40 / 38 / 35	39 / 37 / 35	41 / 38 / 36
Refrigerant		R410A					
Power Supply		Ø, V, Hz					
Power Input (Nominal)	Heat Exchange Mode (SH / H / L)	kW	0.25 / 0.20 / 0.15	0.42 / 0.35 / 0.25	0.48 / 0.42 / 0.27	0.25 / 0.20 / 0.15	0.42 / 0.35 / 0.25
	Bypass Mode (SH / H / L)	kW	0.25 / 0.20 / 0.15	0.42 / 0.35 / 0.25	0.48 / 0.42 / 0.27	0.25 / 0.20 / 0.15	0.42 / 0.35 / 0.25
Nominal Running Current (RLA)	Heat Exchange Mode (SH / H / L)	A	1.5 / 1.3 / 1.0	2.5 / 2.0 / 1.5	3.6 / 3.2 / 2.3	1.5 / 1.3 / 1.0	2.5 / 2.0 / 1.5
	Bypass Mode (SH / H / L)	A	1.5 / 1.3 / 1.0	2.5 / 2.0 / 1.5	3.6 / 3.2 / 2.3	1.5 / 1.3 / 1.0	2.5 / 2.0 / 1.5
Heat Exchange System		Air to air cross flow total heat (Sensible + Latent heat) exchange			Air to air cross flow total heat (Sensible + Latent heat) exchange		
Heat Exchange Element		Specially processed non-flammable paper			Specially processed non-flammable paper		
Air Filter		Multidirectional fibrous fleeces			Multidirectional fibrous fleeces		
Dimensions	W x H x D	mm	1,667 x 365 x 1,140			1,667 x 365 x 1,140	
Net Weight		kg	105			98	
	Liquid	mm	Ø6.35			Ø6.35	
Piping Connection	Gas	mm	Ø12.7			Ø12.7	
	Water	mm	Ø6.35				
	Drain Pipe (Internal Dia.)	mm (inch)	Ø25 (1)			Ø25 (1)	
Connection Duct Diameter		mm	Ø250			Ø250	

Note:

- Cooling Capacity Test condition - Indoor temperature : 27°C DB, 19°C WB / Outdoor temperature : 35°C DB
- Heating Capacity Test condition - Indoor temperature : 20°C DB / Outdoor temperature : 7°C DB, 6°C WB
- Humidifying capacity is based on the following conditions - Indoor temperature : 20°C DB, 15°C WB / Outdoor temperature : 7°C DB, 6°C WB
- Cooling and heating capacities are based on the following conditions : Fan is based on High and Super-high.
- The operating sound measured at the point 1.5 m below the center of the unit is converted to that measured at an anechoic chamber.
- The specifications, designs and information here are subject to change without notice.

Accessories

CHASSIS	LZ-H050GXH4	LZ-H080GXH4	LZ-H100GXH4	LZ-H050GXN4	LZ-H080GXN4	LZ-H100GXN4
Drain Pump						
Cassette Cover						
Refrigerant Leakage Detector				PRLDNV50		
EEV Kit						
Independent Power Module						
Robot Cleaner						
Pre Filter (Washable)						
Ion Generator						
CO ₂ Sensor				AHCS100HO		
Ventilation Kit						
IR Receiver						
Zone Controller						
Dry Contact (with additional accessory)				PDRYCB000 (1 point contact), PDRYCB500 (Modbus)		
External Input (1 point)				○		
Wi-Fi						

※ ○ : Applied, - : Not applied
Option : Refer to model name in table

214 - 243 CHILLER

INVERTER SCROLL CHILLER / FCU

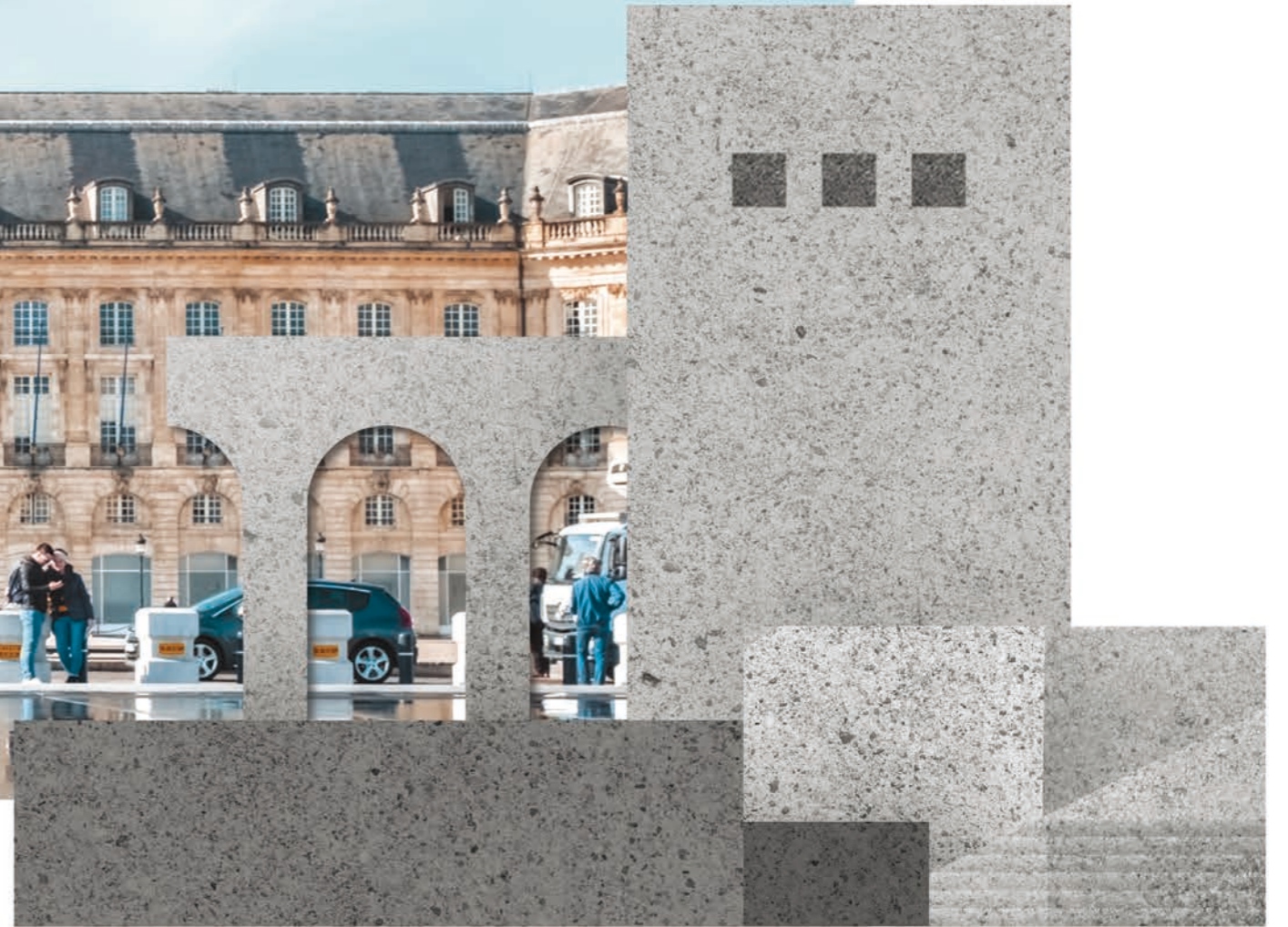
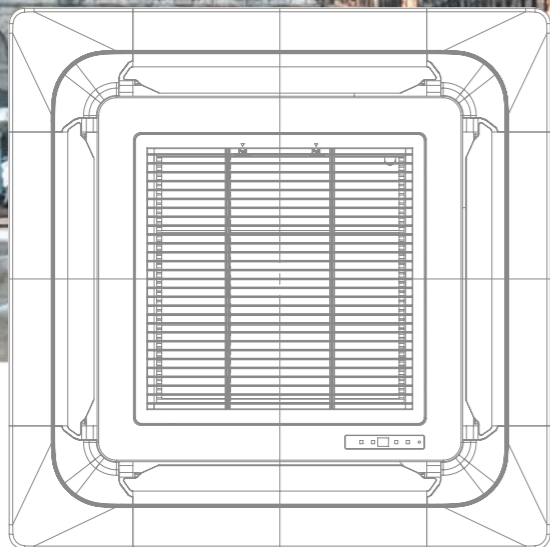
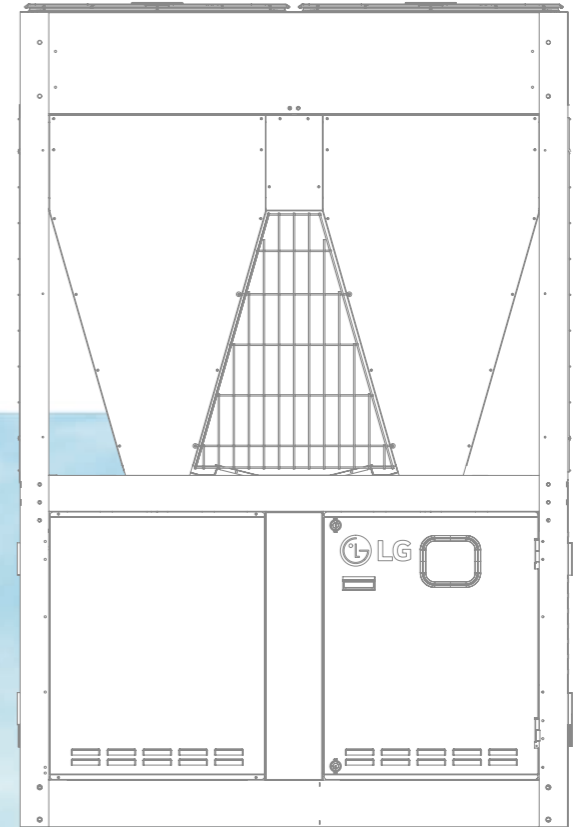

INVERTER SCROLL CHILLER

Capacity (kW)		65	74	114	130	148	171	195	222	
Capacity (Kw)	Cooling	65	74	114	130	148	171	195	222	
	Heating	70.3	82	120	140.6	164	180	210.9	246	
Range of Unit Control		Up to 1,110 kW (5 CHILLERS) by AC Smart Controller			Up to 1,110 kW (5 CHILLERS) by HMI Touch controller			Up to 2,220 kW (10 CHILLERS) by ACP (Advanced Control Platform)		

FCU

		(kW)*	1.8	2.7	3.2	4.1	6	7.2	9	10.5	13
		(kBtu/h)	6k	9k	11k	14k	20k	24k	30k	36k	44k
Ceiling Mounted Cassette	4 Way Cassette		●	●	●	●	●	●	●	●	●
	Body Size (W×H×D, mm)		570 × 214 × 570		570 × 256 × 570	840 × 204 × 840		840 × 246 × 840			
	Front Panel		PT-UQC, PT-QCHW0 (U-Style)		PT-UMC						
Ceiling Mounted Duct	Low ESP Duct		●	●	●	●	●	●	●	●	●
	Body Size (W×H×D, mm)		700 × 190 × 700		900 × 190 × 700		1,100 × 190 × 700				

※ All lineups are for 2 pipes type only.
* Based on Cooling Capacity. Cooling Capacity testing condition : Inlet/Outlet Water Temperature 7°C / 12°C, Indoor Air Temperature 27°CDB / 19°CWB

ACCESSORIES & PARTS FOR WATER PIPES CONNECTION

Remote Controller	Dry Contact	ETC.	Parts for Water Pipes Connection (Purchase on Site)	(installer Purchase)
 Premium PREMTA000(A/B)	 PDRYCB000 (Simple)	 Remote Temperature Sensor PQRSTA0	 Rubber Packing (4EA, OD23 × ID15 × t3.2)	 Ball Valve (2EA, FPT ¼", 20A)
 Standard III ¹⁾ PREMTB100 (White) PREMTBB10 (Black)	 PDRYCB400 (2 points)	 Wi-Fi Modem PWFMD200	 Flexible Pipe (2EA, FPF ¼", 350mm/500mm Ordered Specification)	 Nipple (2EA, MPT ¼", MPF ¼")
 Standard II PREMTB001 (White) PREMTBB01 (Black)	 PDRYCB320 (for Thermostat)	 Independent Power Module PRIPO	 Nipple (2EA, MPT ¼", MPF ¼")	 Strainer (1EA, FPF ¼", #30)
 Simple PQRVCLOQ(W) PQRCHCA0Q(W) (for Hotel)		 Group Control Wire PZCWRG3	 2Way Valve (On/Off, 2-wires or 3wires)	 Water Pipe (2EA, 20A, Copper or Stainless Tube)
 Wireless Remote Controller PWLSSB21H/C (Heat Pump/Cooling Only)		 2-Remo. Control Wire PZCWRC2	 Valve insulation Material (1EA)	
		 Extension Wire PZCWRC1		
		 Drain Hose ³⁾ (1EA, 5m)		

1) It could not be operated some functions.
2) The dry contact for Modbus is built-in to the FCU as default.
3) Included with installation parts



ULTIMATE INVERTER COMPRESSOR

As the core technology of the air conditioning system, the Ultimate Inverter Compressor of MULTI V 5 boasts its ultimate efficiency and durability, designed based on the unique technology and innovation of LG HVAC.

All Inverter

Provide high efficiency with low vibration and low noise

Six By-pass Valves

Prevent compressor damage due to excessively compressed refrigerant more efficiently than 4 by-pass valves

01. Vapor Injection

Wide operating range via two-stage compression

02. Enhanced Bearing with PEEK Material

Newly invented system motivated by PEEK (Polyetheretherketone) bearing used for aero engine to increase operation range and durability

03. Wide Operation Range from 30 to 130 Hz

Improved part load efficiency at all operation ranges

04. HiPOR™ (High Pressure Oil Return)

Resolve compressor efficiency loss caused by oil return

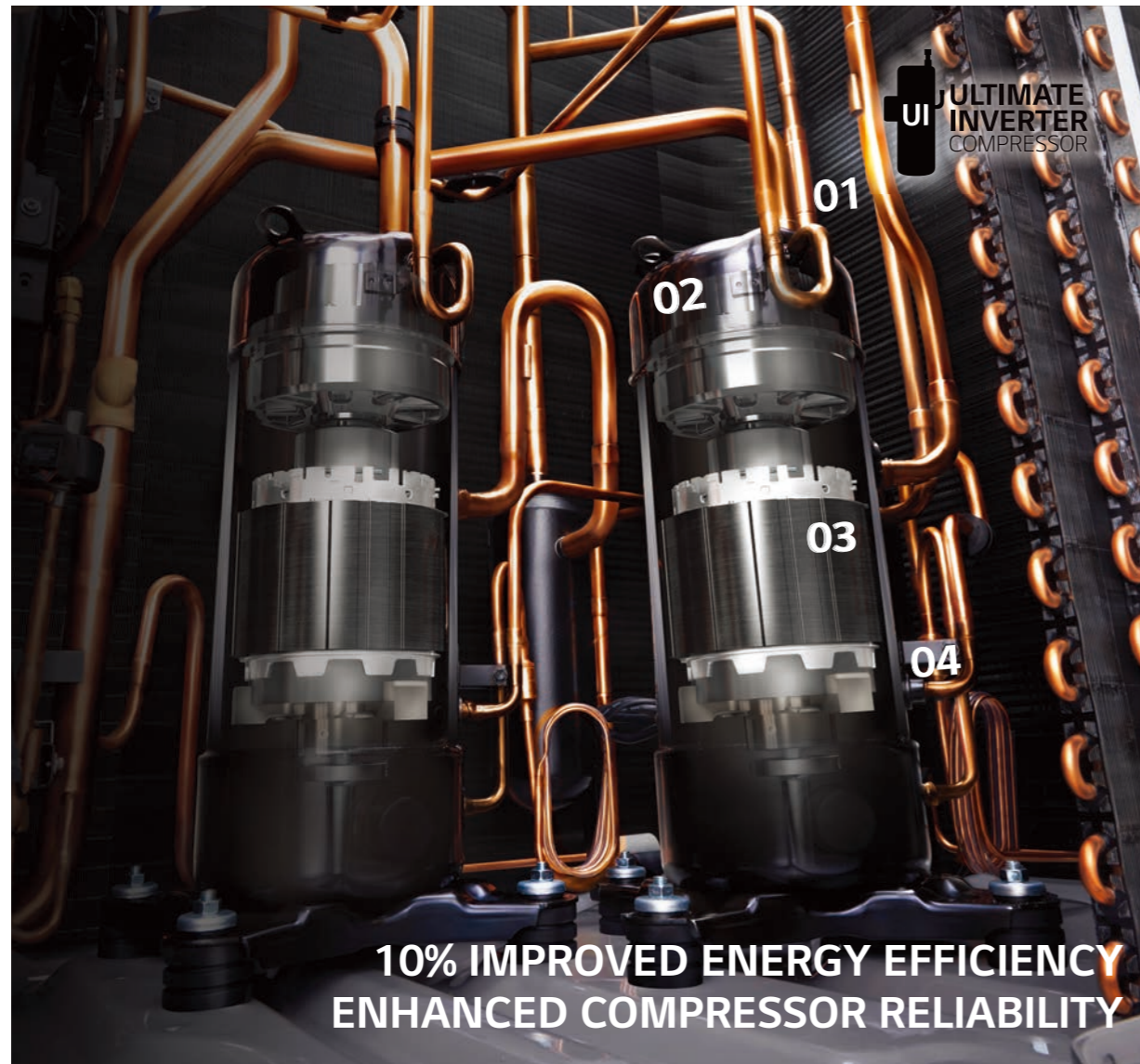

Smart Farm



Small Industry (Process Water)



Hotel / Office

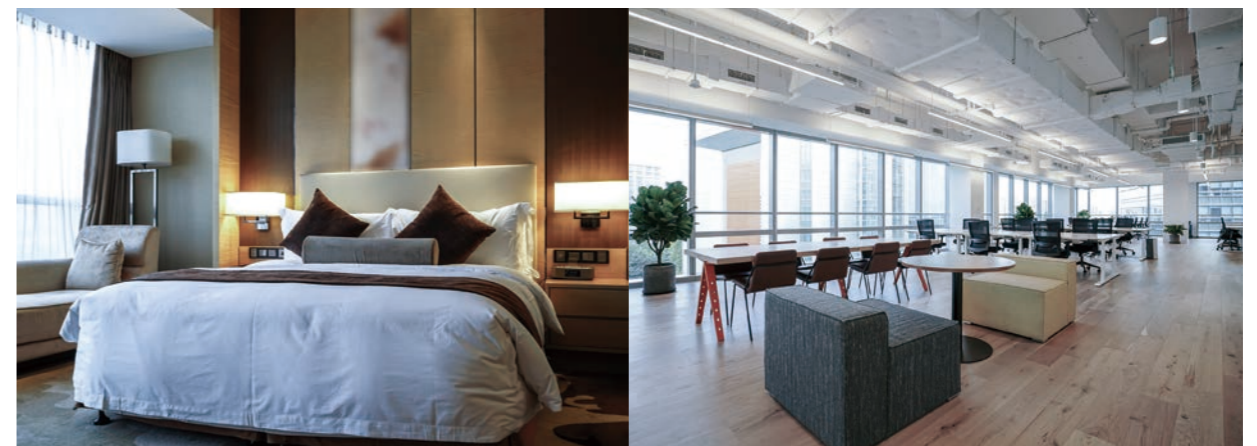

All Inverter Scroll Compressor

All inverter scroll compressor with HiPOR™ (Patent) is applied to improve full load and part load energy efficiency.

All Inverter System

Wide operation frequency range 30 - 130Hz

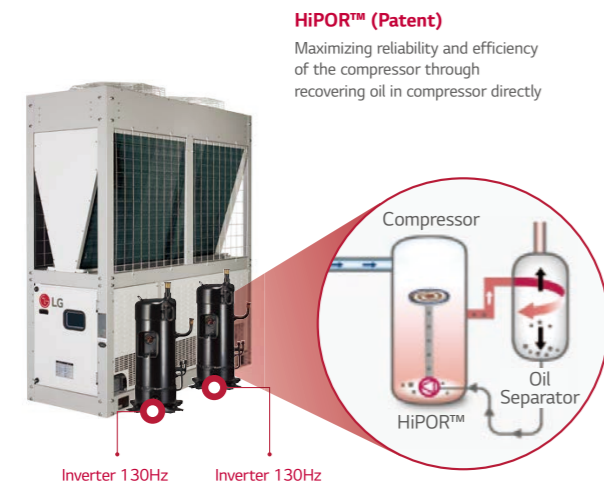

Compressor Efficiency

Compressor efficiency by Hz is increased through HiPOR™ application

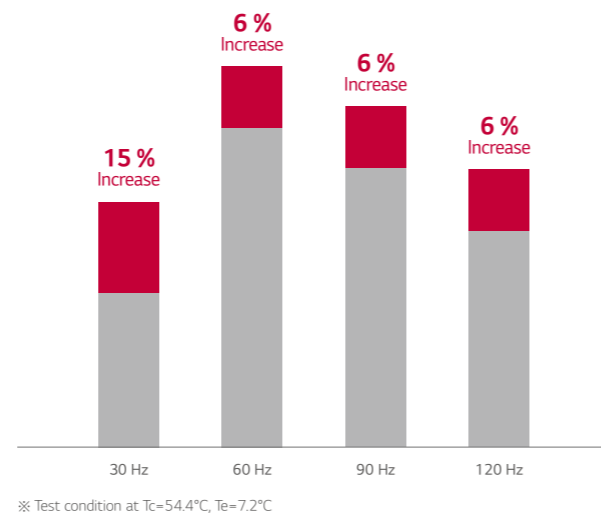

Lower Load Operation

20% part load operation and minimized water outlet temperature haunting with Inverter scroll compressor.

LG Inverter Scroll Compressor

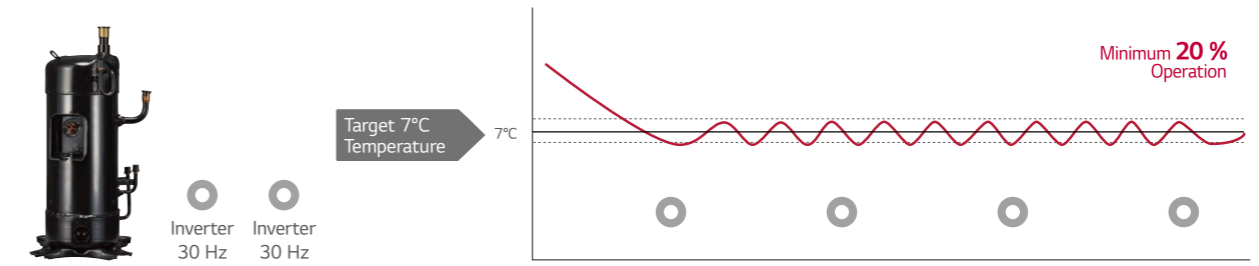

Normal On/Off Multi Compressor System

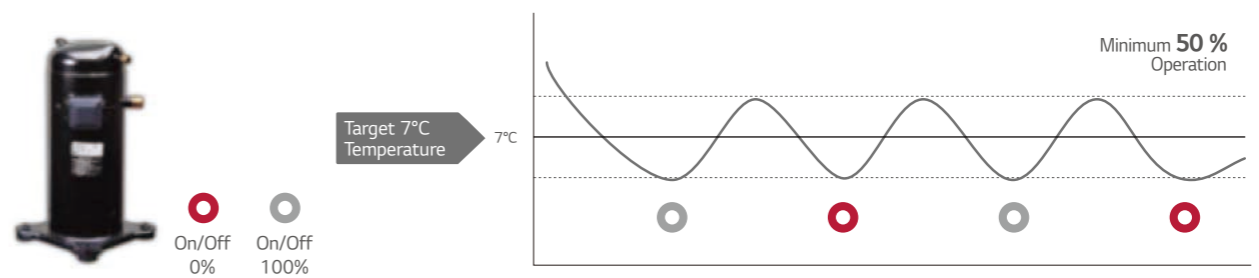

App. Inverter Comp. vs Constant Speed Comp.

Inverter compressor is more stable and efficient solution than Constant speed compressor.

Comparison of starting type

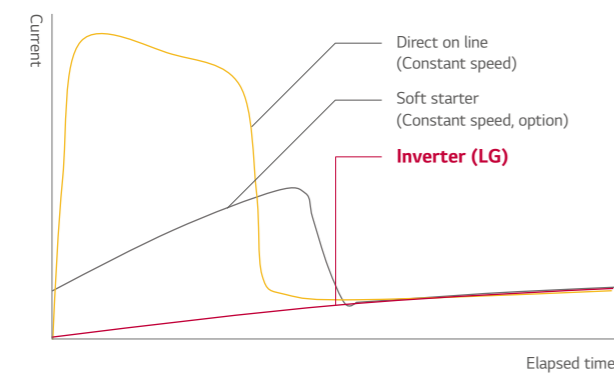

Compressor	Starting type	Starting current (Is / FLA*, %)
Constant speed	Direct on line	About 650 %
	Soft starter	200 - 350 %
Inverter (LG)	Inverter	No inrush current

* FLA : Full load ampere

Inverter's feature & benefits

When starting

Reduce starting torque below full load torque

➔ **Mechanical wear↓**

Decrease starting current under FLA

➔ **Circuit breaker capacity↓**

When operating

Low electric loss due to high value of the power factor**

➔ **Energy efficient**

Low power input in part load

➔ **High SEER**

Continuously adjust compressor output according to the load (Compressor 15-125Hz)

➔ **Save energy**

** Power factor : Ratio between active power(kW) and total power(kVA)

High Energy Efficiency

All inverter scroll compressors with Multi V technologies improve energy efficiency.

Cooling Performance

EER

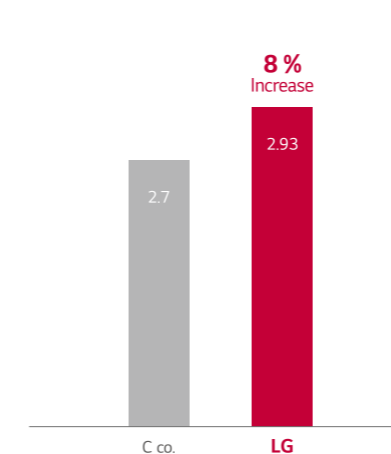

Heating Performance

COP

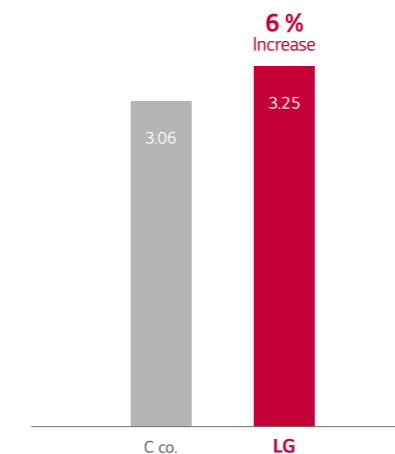

SCOP

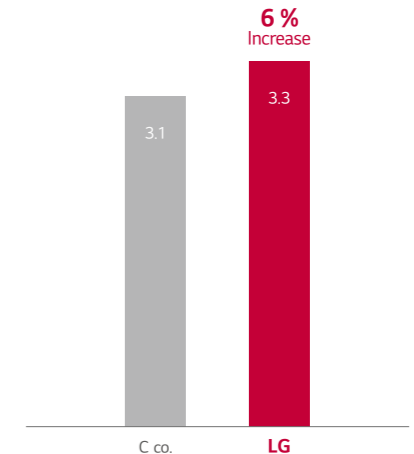

※ 65 kW Heat pump model comparison

Continuous Heating Operation

Continuous heating minimizes the decrease of water outlet temperature during defrosting for multi circuit model.

Multi cycle can defrost each cycle individually to supply hot water continuously multi cycle.

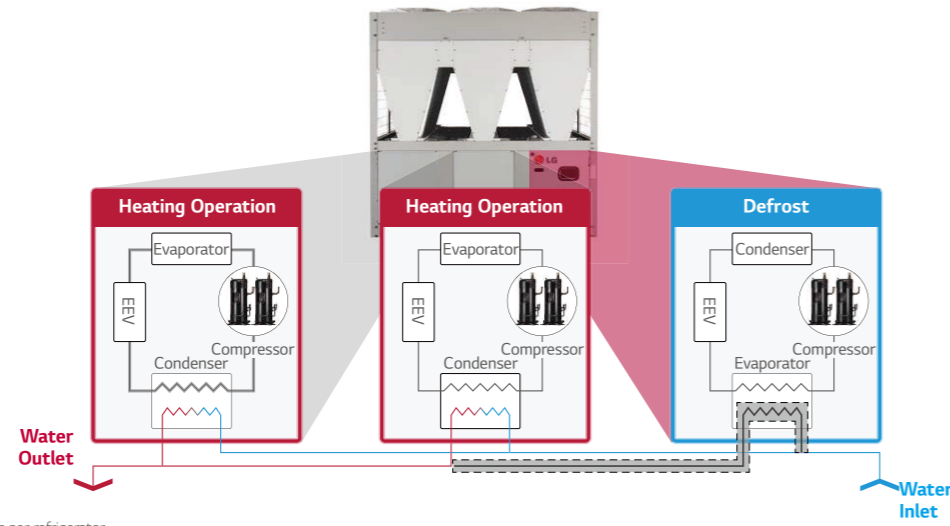

* Applied up to 6 scroll compressors per refrigerator

Back Up Operation

If one compressor or one cycle needs to be repaired, backup operation helps the whole system to operate continuously.

All Inverter System



Cycle back up

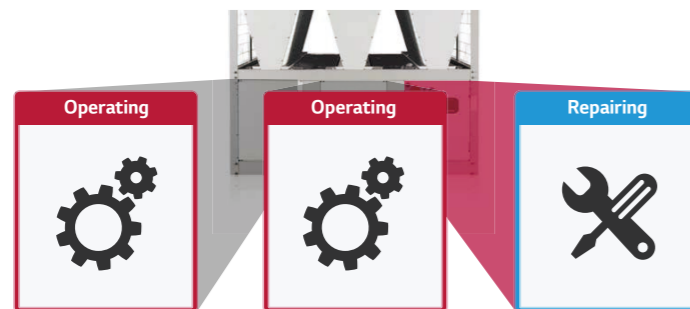

Corrosion Resistance (Black Fin)

'Black Fin' heat exchanger is highly corrosion resistant, designed to perform in corrosive environments such as contaminated and humid condition.

Black Fin

- Longer lifespan, lower operational costs
- Strengthened corrosion resistant coating

Hydrophilic Coating

The hydrophilic coating minimizes moisture build up on the fin.

Corrosion Resistant Black Coating

The black coating provides strong protection from corrosion.

Aluminum Fin

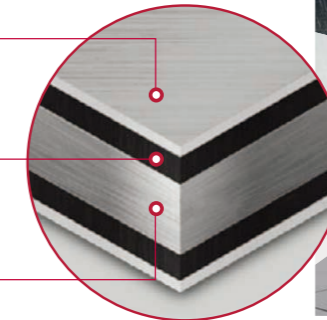

Black Box Function

Quick service can be done because operation data can be saved for 180 seconds before system failure.

Without Black Box Function

Check many failure causes and error codes in person

With Black Box Function

Search for the failure cause conveniently using recorded data



Compact Size

Compact size reduces concern about installation and service space.

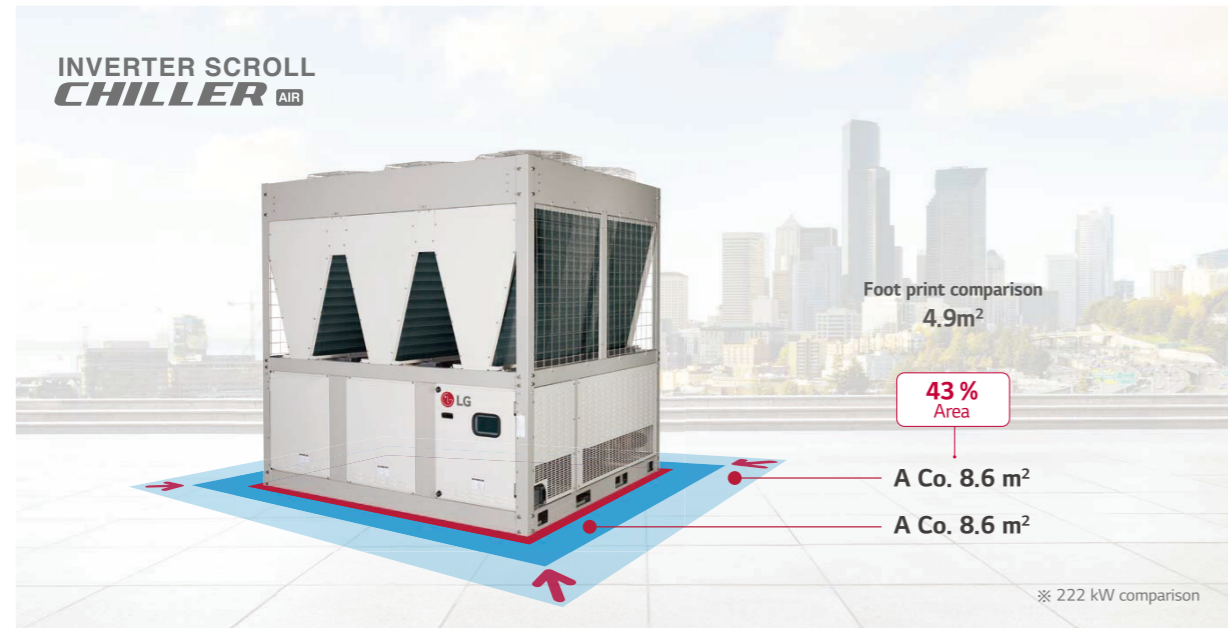

Low Noise Level

Lower noise can reduce noise pollution and provide a quieter environment.

Noise Comparison



Silent Operation Function (Cooling Mode)

Silent operation function can reduce noise levels at night time by adjusting the fan RPM.

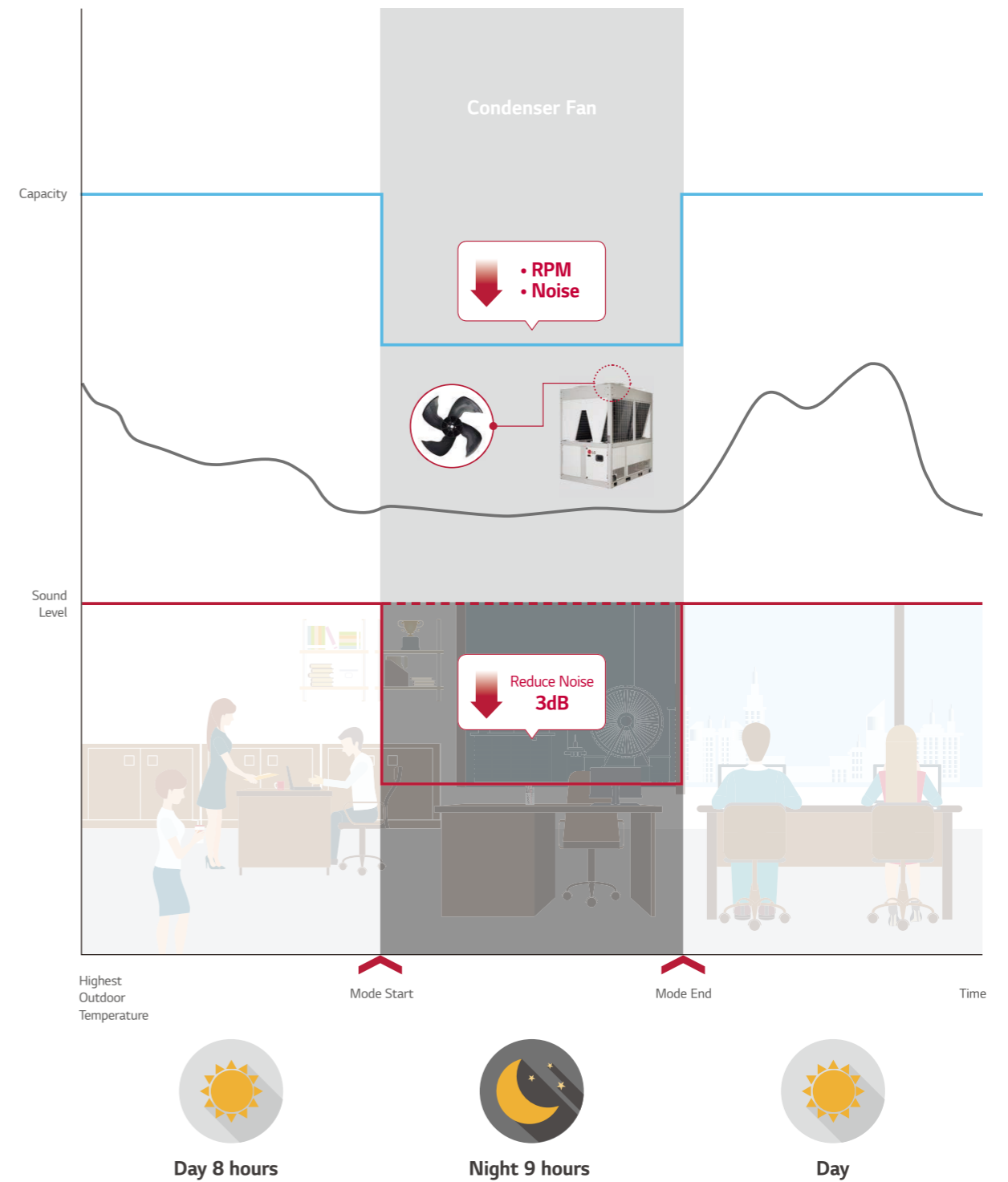

**ACHH020LBAB / ACHH023LBAB
ACHH033LBAB / ACHH040LBAB**



LG participates in the ECP programme for EUROVENT VRF program. Check ongoing validity of certification : www.eurovent-certification.com

Heat pump model

INVERTER SCROLL CHILLER			ACHH020LBAB	ACHH023LBAB	ACHH033LBAB	ACHH040LBAB
			H/P	H/P	H/P	H/P
Power	Phase/Lines/V		3,4,380-415	3,4,380-415	3,4,380-415	3,4,380-415
Capacity	Cooling	kW	65	74	114	130
		RT	18.5	21	32.4	37
	Heating	kW	70.3	82	120	140.6
		RT	20	23	34	40
Input Power	Cooling	kW	22.2	27.4	36.8	44.4
	Heating	kW	21.6	27.3	35.3	43.3
Max operating Current	A		39	48	72	78
Efficiency	Cooling	W/W	2.93	2.70	3.10	2.93
	Heating	W/W	3.25	3.00	3.40	3.25
SEER	W/W		4.40	4.20	4.50	4.40
SCOP	W/W		3.30	3.30	3.30	3.30
Sound Pressure	dB(A)		67	68	68	68
Sound power	Cooling	dB(A)	86	87	87	90
	Heating	dB(A)	86	87	88	90
Compressor	Type	-	Scroll	Scroll	Scroll	Scroll
	No. of Compressor	EA	2	2	4	4
	Oil Type	-	PVE	PVE	PVE	PVE
	Oil charge	cc	1,400 x 2	1,400 x 2	1,400 x 4	1,400 x 4
	Sump Heater	W	60 x 2	60 x 2	60 x 4	60 x 4
	Type	-	R410A	R410A	R410A	R410A
	Amount of Charged	Kg	7.0 kg x 2	7.0 kg x 2	7.0 kg x 4	7.0 kg x 4
Evaporator	Type	-	plate	plate	plate	plate
	Pressure drop	kPa	21.5	28.7	18.7	21.5
	Operating maximum pressure (Refrigerant / Water)	kg/cm ²	42/10	42/10	42/10	42/10
	Standard Flow (Cooling/Heating)	LPM	186/200	211/235	327/345	372/400
	Inlet/Outlet diameter (Water pipe)	mm	50A/50A	50A/50A	65A/65A	65A/65A
Fan motor	Type	-	BLDC	BLDC	BLDC	BLDC
	No. of Fan	EA	2	2	4	4
	No. of Vanes	EA	4	4	4	4
	Air Flow Rate	CMM	210 x 2 @1,000 rpm	210 x 2 @1,000 rpm	210 x 4 @1,000 rpm	210 x 4 @1,000 rpm
	Motor power	W	900 x 2	900 x 2	900 x 4	900 x 4
Expansion unit	-	EEV	EEV	EEV	EEV	
Weight	kg		520	520	970	970
	mm	W	765	765	1,528	1,528
Dimension	H	mm	2,293	2,293	2,293	2,293
	D	mm	2,154	2,154	2,154	2,154
	Footprint	m ² / RT	0.089	0.078	0.102	0.089
Protection Devices	High/Low Pressure	-	•	•	•	•
	Anti Frost	-	•	•	•	•
Remote Control	-	Modbus	Modbus	Modbus	Modbus	
Power	Power Line	mm ²	25.0mm ² x 5C	25.0mm ² x 5C	50.0mm ² x 5C	50.0mm ² x 5C
Outlet Temperature	Cooling	°C	5-20	5-20	5-20	5-20
	Heating	°C	30-55	30-55	30-55	30-55
Ambient Temperature	Cooling	°C	-15-48	-15-48	-15-48	-15-48
	Heating	°C	-30-35	-30-35	-30-35	-30-35
Earth Leakage Breaker	A		75	75	125	125

- Notes :
- Due to our policy of innovation some specifications may be changed without prior notification.
 - Capacities and Inputs are based on the following conditions
Cooling : Outdoor air temp. 35°C, Water inlet temp. 12°C, Water Outlet temp. 7°C
Heating : Outdoor air temp. 7°C, Water inlet temp. 40°C, Water Outlet temp. 45°C
 - Sound pressure level is measured on the rated condition in the anechoic rooms by ISO 3745 standard.
Sound power level is measured ISO 9614:2009 by sound intensity method. Therefore, these values can be increased owing to ambient conditions during operation.

**ACHH045LBAB / ACHH050LBAB
ACHH060LBAB / ACHH067LBAB**



LG participates in the ECP programme for EUROVENT VRF program. Check ongoing validity of certification : www.eurovent-certification.com

Heat pump model

INVERTER SCROLL CHILLER			ACHH045LBAB	ACHH050LBAB	ACHH060LBAB	ACHH067LBAB
			H/P	H/P	H/P	H/P
Power	Phase/Lines/V		3,4,380-415	3,4,380-415	3,4,380-415	3,4,380-415
Capacity	Cooling	kW	148	171	195	222
		RT	42.1	48.6	55.4	63.1
	Heating	kW	164	180	210.9	246
		RT	47	51	60	70
Input Power	Cooling	kW	54.8	55.2	66.6	82.2
	Heating	kW	54.7	52.9	64.9	82
Max operating Current	A		96	108	117	144
Efficiency	Cooling	W/W	2.70	3.10	2.93	2.70
	Heating	W/W	3.00	3.40	3.25	3.00
SEER	W/W		4.20	4.50	4.40	4.20
SCOP	W/W		3.30	3.30	3.30	3.30
Sound Pressure	dB(A)		68	68	68	68
Sound power	Cooling	dB(A)	91	88	91	92
	Heating	dB(A)	91	88	91	92
Compressor	Type	-	Scroll	Scroll	Scroll	Scroll
	No. of Compressor	EA	4	6	6	6
	Oil Type	-	PVE	PVE	PVE	PVE
	Oil charge	cc	1,400 x 4	1,400 x 6	1,400 x 6	1,400 x 6
	Sump Heater	W	60 x 4	60 x 6	60 x 6	60 x 6
	Type	-	R410A	R410A	R410A	R410A
	Amount of Charged	Kg	7.0 kg x 4	7.0 kg x 6	7.0 kg x 6	7.0 kg x 6
Evaporator	Type	-	plate	plate	plate	plate
	Pressure drop	kPa	28.7	18.7	21.5	28.7
	Operating maximum pressure (Refrigerant / Water)	kg/cm ²	42/10	42/10	42/10	42/10
	Standard Flow (Cooling/Heating)	LPM	411/470	490/518	558/600	633/705
	Inlet/Outlet diameter (Water pipe)	mm	65A/65A	65A/65A	65A/65A	65A/65A
Fan motor	Type	-	BLDC	BLDC	BLDC	BLDC
	No. of Fan	EA	4	6	6	6
	No. of Vanes	EA	4	4	4	4
	Air Flow Rate	CMM	210 x 4 @1,000 rpm	210 x 6 @1,000 rpm	210 x 6 @1,000 rpm	210 x 6 @1,000 rpm
	Motor power	W	900 x 4	900 x 6	900 x 6	900 x 6
Expansion unit	-	EEV	EEV	EEV	EEV	
Weight	kg		970	1,430	1,430	1,430
	mm	W	1,528	2,291	2,291	2,291
Dimension	H	mm	2,293	2,293	2,293	2,293
	D	mm	2,154	2,154	2,154	2,154
	Footprint	m ² / RT	0.078	0.101	0.089	0.078
Protection Devices	High/Low Pressure	-	•	•	•	•
	Anti Frost	-	•	•	•	•
Remote Control	-	Modbus	Modbus	Modbus	Modbus	
Power	Power Line	mm ²	50.0mm ² x 5C	95.0mm ² x 5C	95.0mm ² x 5C	95.0mm ² x 5C
Outlet Temperature	Cooling	°C	5-20	5-20	5-20	5-20
	Heating	°C	30-55	30-55	30-55	30-55
Ambient Temperature	Cooling	°C	-15-48	-15-48	-15-48	-15-48
	Heating	°C	-30-35	-30-35	-30-35	-30-35
Earth Leakage Breaker	A		125	200	200	200

- Notes :
- Due to our policy of innovation some specifications may be changed without prior notification.
 - Capacities and Inputs are based on the following conditions
Cooling : Outdoor air temp. 35°C, Water inlet temp. 12°C, Water Outlet temp. 7°C
Heating : Outdoor air temp. 7°C, Water inlet temp. 40°C, Water Outlet temp. 45°C
 - Sound pressure level is measured on the rated condition in the anechoic rooms by ISO 3745 standard.
Sound power level is measured ISO 9614:2009 by sound intensity method. Therefore, these values can be increased owing to ambient conditions during operation.



Fan Coil Unit

FCU can be applied to various solutions using water. It allows not only to control equipment individually by using the remote controller, but also apply integrated control including control of some external equipment and devices through the central controller.

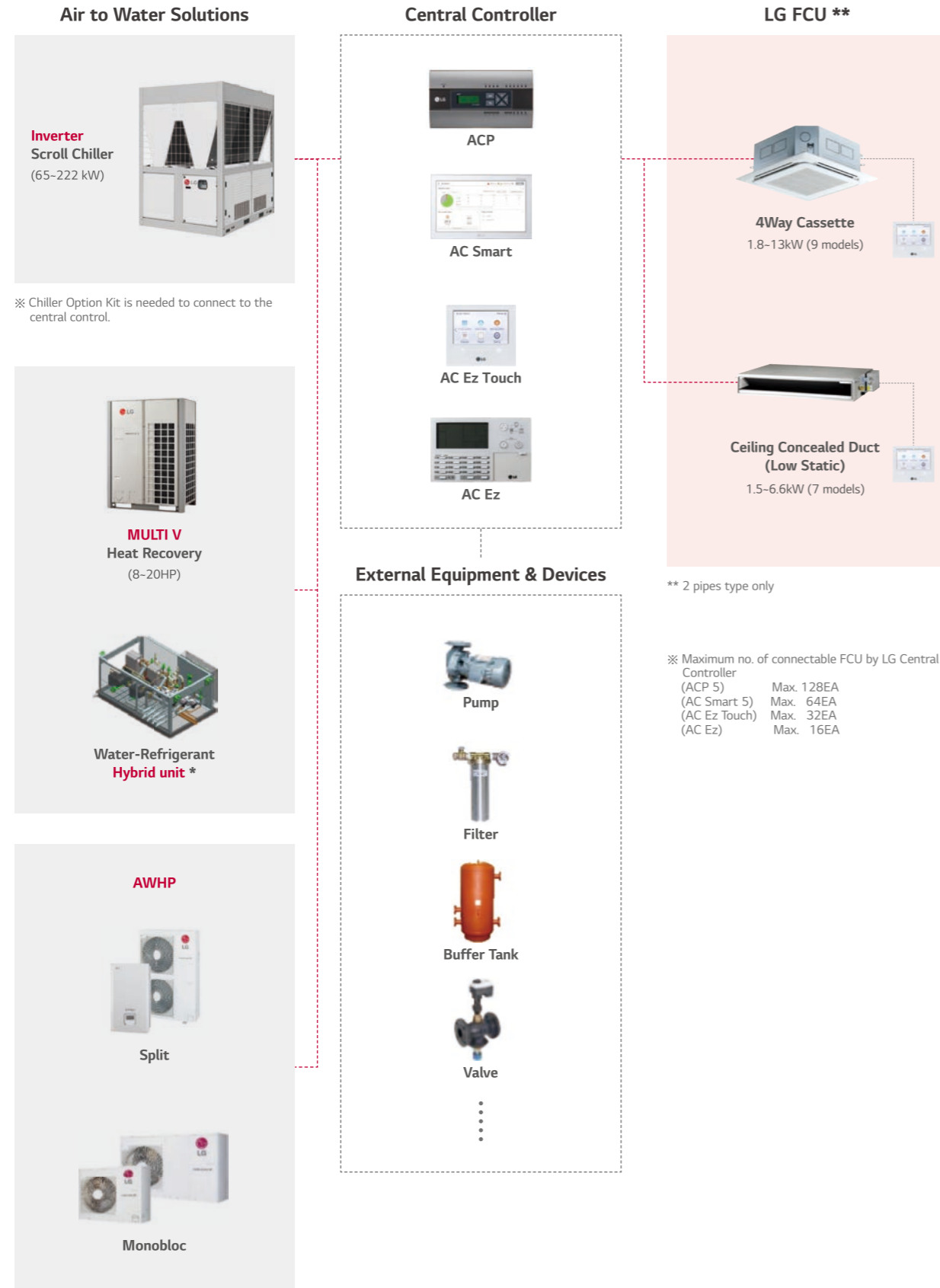

* To be released in the 1st half of 2020

Interlocking Control

It allows Interlocking control between FCU and Inverter Scroll Chiller(ISC) by using LG central controller such as ACP, ACS. When FCU is being turned on/off, ISC turns on/off automatically by LG central controller.

What are the benefits?

The Total Cost(Equipment + installation + BMS) is greatly reduced. It eliminated the hassle of turning on the ISC first.

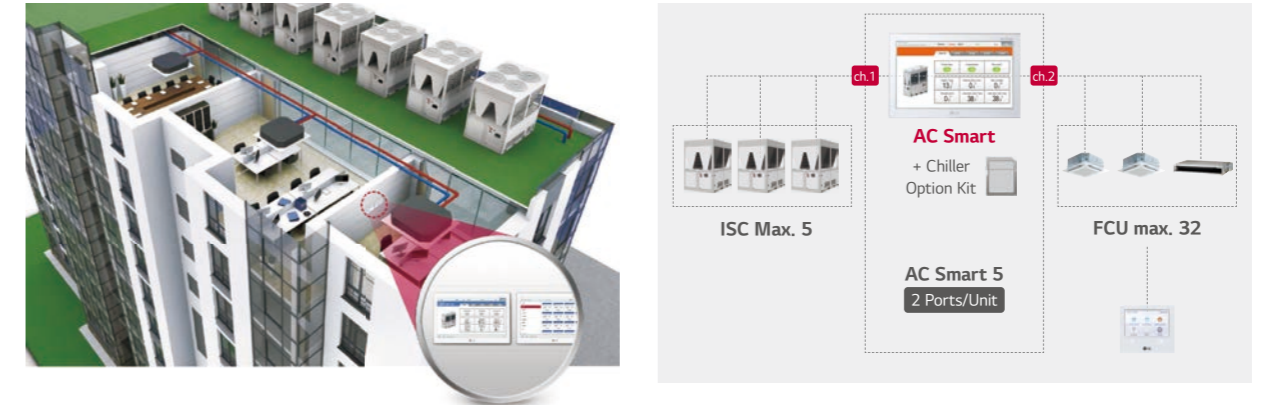

Central Controller

LG's central controller allows control of various external equipment and devices in addition to LG's equipment. (FCU, Chiller, EHP, etc.)

What are the benefits?

Integrated control of the system can be realized conveniently through the LG central controller. (FCU + Chiller + EHP + ... + External Equipment & Devices)

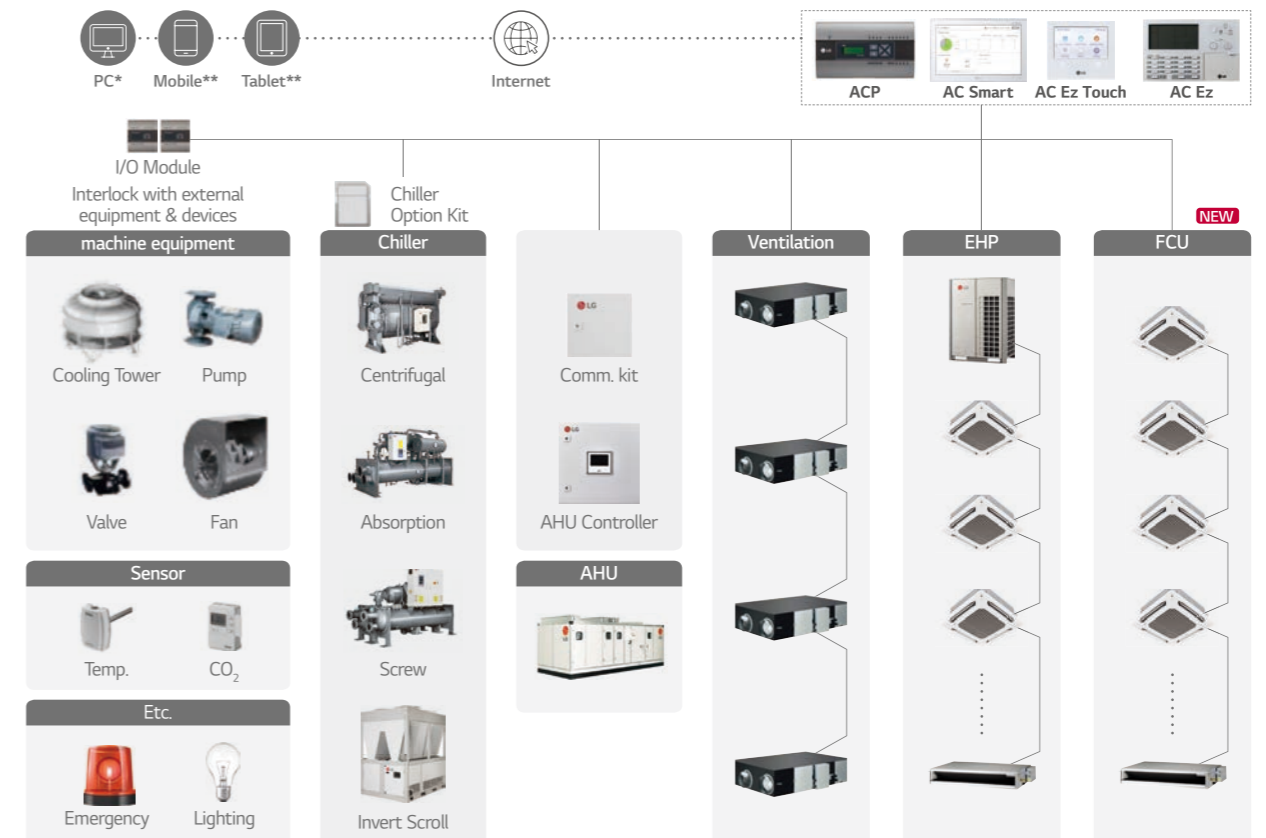

* Unable to link AC Ez ** Unable to link AC Ez, AC Ez Touch

Scheduled Operation

You can set 2 schedules for one day, and up to 14 schedules for a week.

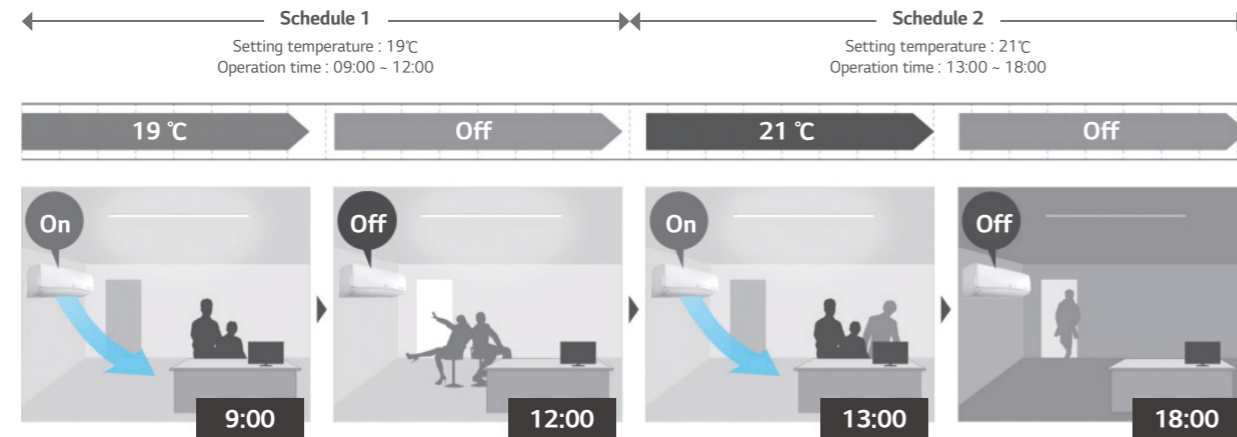

※ This function is for wired remote controller only
 ※ Wired remote controller is need to be separately purchased.

Group Control with One Remote Controller

Up to 16 FCU's can be controlled with one wired remote controller. It can reduce installation costs and keep the wall interior clean.



※ If you set up to 'Installation Setting' > Group Control 'Enabled' in your Wired Remote Controller, you can use many more functions.

Easy Control (Simple Test Run via LGMV)

LG MV (Monitoring View) helps engineers to inspect and monitor LG's air conditioning unit easily.



※ Search "Mobile LGMV" on Google market or App store then download the app.
 ※ Wi-Fi modem (PWFMD200) is required by option.

Individual Control & External Central Control

It allows not only to control each room by using the remote controller, but also apply integrated control through a 3rd party central controller.

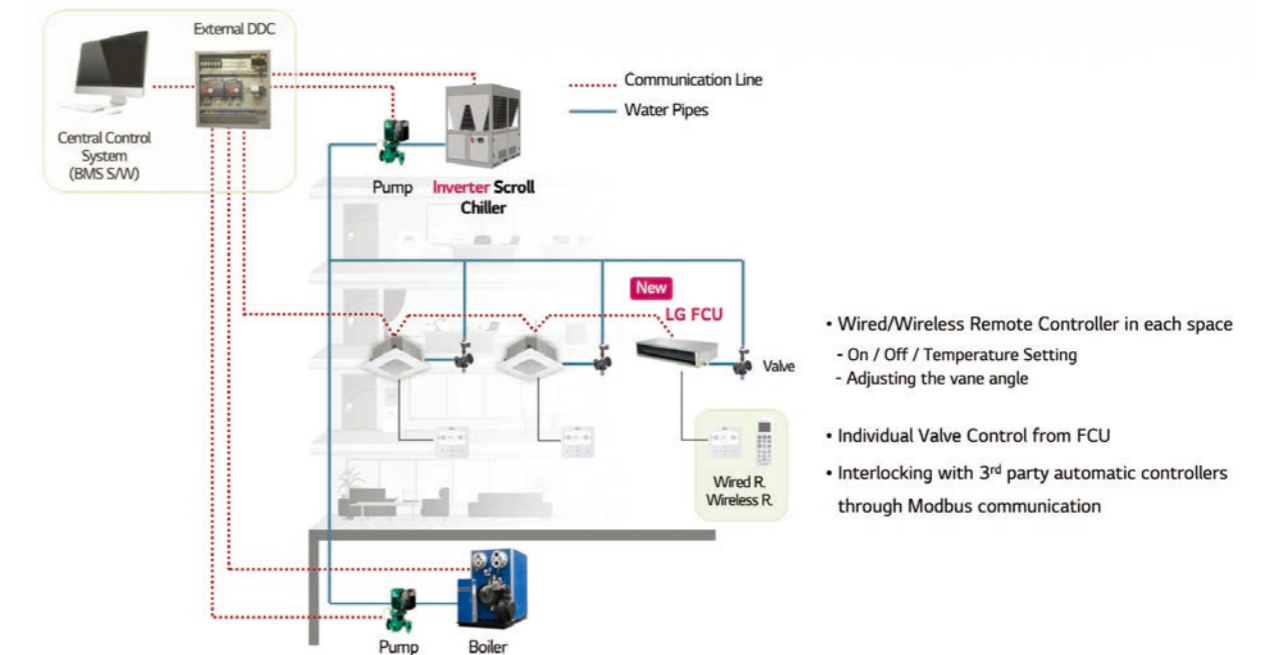



Stylish Design Panel

(U-style 4Way cassette)

New 4 way cassette panel adapted a unibody shape and fits into the ceiling cell size.

Compact Size

Panel size is fit into the ceiling tile.



Interior fit



Lineless surface

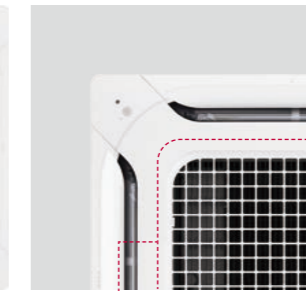

Detachable corner



Unibody shape (No inlet line)

※ U-Style panel corresponds to the PT-QCHW0 panel for WF4A018 / 027 / 032 / 041CG0A models.

High Ceiling Mode

Airflow in a space with a 4.2m ceiling height is possible with this indoor unit. Furthermore, air flow can be strengthened by adjusting the fan speed.

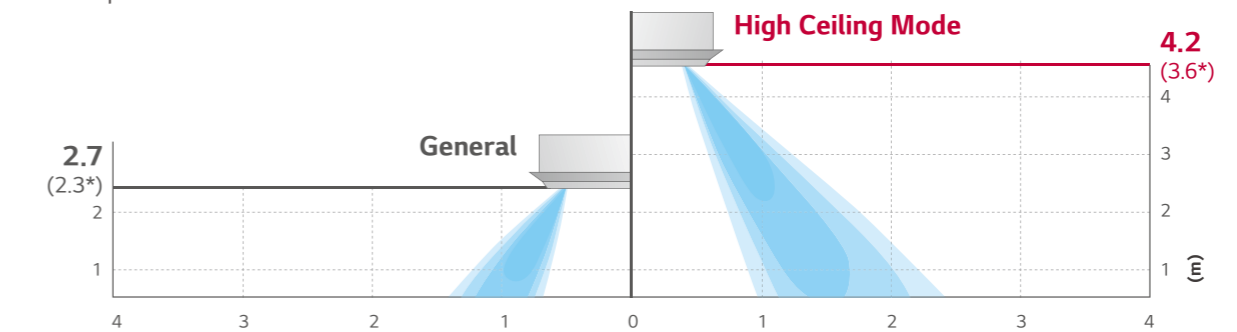

* For models less than 9.0 kW.

Wi-Fi Remote Control

Control your air conditioners using the smart devices as Android or iOS based smartphones and voice commands via Google assistant.

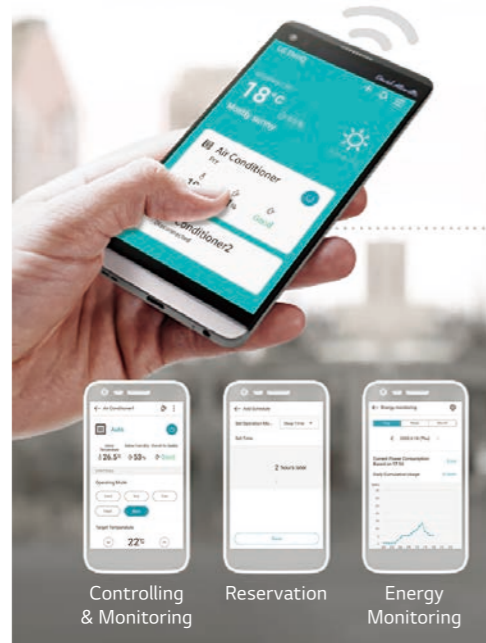

Access your air conditioner anytime and from anywhere

Operation under the revised weather conditions before changing conditions impact indoor comfort.

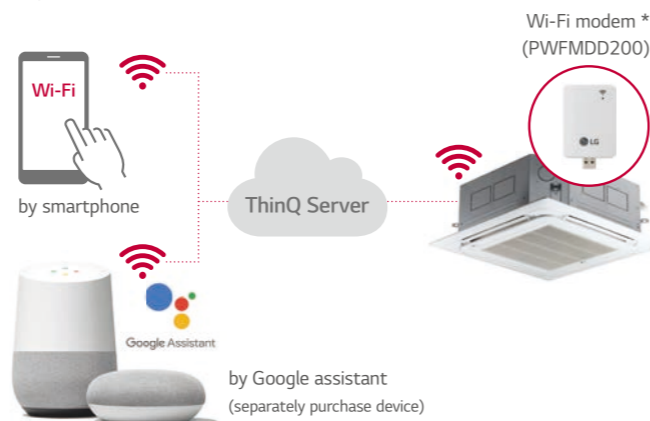

Simple operation for various functions

- On/Off **
- Mode Selection **
- Current temperature **
- Set temperature **
- Set fan speed **
- Vane Control
- Reservation
- Energy Monitoring
- Filter Management
- Smart Diagnosis

** This functions are used by Google assistant & Amazon Alexa
 ※ In some countries, the use of the Google assistant & Amazon Alexa system may be restricted.

Convenient Panel Installation

The detachable corner design makes it easy to adjust the hanger during installation and helps to easily check leakages in the drain connection pipe. Moreover, button type holder design makes it is easy to install the panel to the body.

Detachable Corner Design

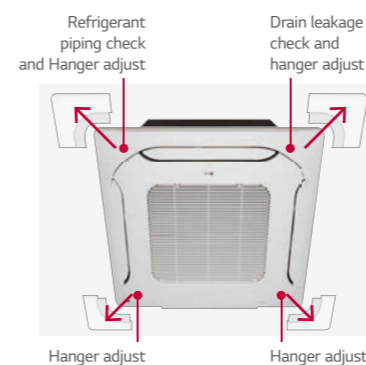

Drain Leakage Check

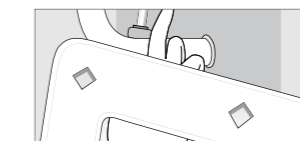

Hanger adjust

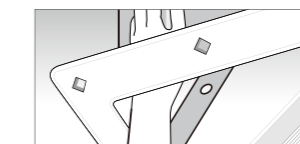

One Push Panel



※ The detachable corner design is only applicable to the U-Style panel.

**WF4A018CG0A / WF4A027CG0A
WF4A032CG0A / WF4A041CG0A
WF4A060CG0A**



INDOOR			WF4A018CG0A	WF4A027CG0A	WF4A032CG0A	WF4A041CG0A	WF4A060CG0A
Power Supply	Ø, V, Hz		1, 220-230-240, 50/60	1, 220-230-240, 50/60	1, 220-230-240, 50/60	1, 220-230-240, 50/60	1, 220-230-240, 50/60
Running Current by Voltage	A		0.37-0.37-0.37	0.38-0.38-0.38	0.40-0.40-0.40	0.35-0.42-0.42	0.62-0.69-0.69
Capacity	Cooling	Condition A	1.8 (1,548)	2.7 (2,322)	3.2 (2,752)	4.1 (3,525)	6.0 (5,159)
		Condition B	1.2 (1,032)	1.8 (1,548)	2.2 (1,892)	2.8 (2,408)	4.0 (3,439)
		Condition C	1.5 (1,290)	2.3 (1,978)	2.8 (2,408)	3.6 (3,095)	4.9 (4,213)
		Condition D	0.7 (602)	1.2 (1,032)	1.4 (1,204)	1.8 (1,548)	2.5 (2,150)
	Heating	Condition A	1.9 (1,634)	2.7 (2,322)	3.3 (2,837)	4.5 (3,869)	7.2 (6,191)
		Condition B	2.2 (1,892)	3.1 (2,666)	3.9 (3,353)	5.4 (4,643)	8.5 (7,309)
Water Flow Rate	Cooling	Condition A	5.7	8.2	10.0	13.5	19.0
		Condition B	4.6	6.6	8.0	10.8	14.4
		Condition C	5.7	8.2	10.0	13.5	19.0
		Condition D	3.4	4.9	6.0	8.1	12.1
	Heating	Condition A	6.1	8.6	10.0	13.5	22.5
		Condition B	5.7	8.2	10.0	13.5	19.0
Head Loss	Cooling	Condition A	21.5	32.0	47.7	43.7	38.2
		Condition B	13.7	20.3	30.3	27.8	23.6
		Condition C	21.5	32.0	47.7	43.7	38.2
		Condition D	8.1	12.0	17.9	16.4	17.0
	Heating	Condition A	30.3	40.7	53.8	56.5	57.2
		Condition B	26.2	36.5	53.8	56.5	42.1
Power Input	Nominal	W	12	15	20	43	73
Running Current	Nominal	A	0.37	0.38	0.40	0.42	0.69
Fan	Type	-	Turbo Fan	Turbo Fan	Turbo Fan	Turbo Fan	Turbo Fan
	Air Flow Rate (H / M / L)	m³/min	6.5 / 5.5 / 5.0	7.0 / 6.5 / 6.0	8.5 / 8.0 / 7.0	12.0 / 10.0 / 8.0	19.0 / 17.0 / 15.0
Fan Motor	Type	-	BLDC	BLDC	BLDC	BLDC	BLDC
	Drive	-	CCW	CCW	CCW	CCW	CCW
	Output	W x No.	30 x 1	30 x 1	30 x 1	43 x 1	40 x 1
	FLA (Full Load Ampere)	A	0.37	0.38	0.40	0.42	0.69
Dimensions	Net (W x H x D)	mm	570 x 214 x 570	570 x 214 x 570	570 x 214 x 570	570 x 256 x 570	840 x 204 x 840
Weight	Net	kg	12.9	12.9	12.9	14.0	20.8
	Shipping	kg	15.7	15.7	15.7	16.3	24.9
Air Filter	Type	-	-	-	-	-	-
Temperature Control	-	-	Microprocessor, Thermostat for cooling and heating				
Sound Absorbing / Thermal Insulation Material	-	-	Foamed polystyrene	Foamed polystyrene	Foamed polystyrene	Foamed polystyrene	Foamed polystyrene
Protection Device	-	-	Fuse	Fuse	Fuse	Fuse	Fuse
Water Connecting Pipes	Inlet	-	BSPF G 3/4" (male)	BSPF G 3/4" (male)	BSPF G 3/4" (male)	BSPF G 3/4" (male)	BSPF G 3/4" (male)
	Outlet	-	BSPF G 3/4" (male)	BSPF G 3/4" (male)	BSPF G 3/4" (male)	BSPF G 3/4" (male)	BSPF G 3/4" (male)
Sound Pressure Level	Cooling (H / M / L)	dB (A)	35 / 34 / 33	38 / 37 / 35	43 / 40 / 38	48 / 43 / 38	48 / 46 / 42
	Heating (H / M / L)	dB (A)	35 / 34 / 33	38 / 37 / 35	43 / 40 / 38	48 / 43 / 38	48 / 46 / 42
Sound Power Level	Cooling (H / M / L)	dB (A)	40 / 39 / 38	44 / 42 / 40	50 / 46 / 44	56 / 50 / 45	55 / 53 / 49
	Heating (H / M / L)	dB (A)	40 / 39 / 38	44 / 42 / 40	50 / 46 / 44	56 / 50 / 45	55 / 53 / 49
Connecting Cable	Communication Cable (VCTF-SB)	mm² x cores	1.0 - 1.5	1.0 - 1.5	1.0 - 1.5	1.0 - 1.5	1.0 - 1.5
	Name	-	PT-QCHW0	PT-QCHW0	PT-QCHW0	PT-QCHW0	PT-MCHW0
Decoration Panel #1 (Accessory)	Dimensions (W x H x D)	mm	620 x 34 x 620	620 x 34 x 620	620 x 34 x 620	620 x 34 x 620	950 x 35 x 950
	Color	-	Morning fog	Morning fog	Morning fog	Morning fog	Morning fog
	RAL Code	-	120-4	120-4	120-4	120-4	120-4
	Name	-	-	-	-	-	-
Decoration Panel #2 (Accessory)	Dimensions (W x H x D)	mm	-	-	-	-	-
	Color	-	-	-	-	-	-
	RAL Code	-	-	-	-	-	-

**WF4A072CG0A / WF4A090CG0A
WF4A105CG0A / WF4A130CG0A**



INDOOR			WF4A072CG0A	WF4A090CG0A	WF4A105CG0A	WF4A130CG0A	
Power Supply	Ø, V, Hz		1, 220-230-240, 50/60	1, 220-230-240, 50/60	1, 220-230-240, 50/60	1, 220-230-240, 50/60	
Running Current by Voltage	A		0.75-0.88-0.88	0.89-0.89-0.89	1.4-1.39-1.39	1.7-1.88-1.88	
Capacity	Cooling	Condition A	7.2 (6,191)	9.0 (7,739)	10.5 (9,028)	13.0 (11,178)	
		Condition B	4.8 (4,127)	6.0 (5,159)	7.0 (6,019)	8.7 (7,481)	
		Condition C	5.8 (4,987)	7.3 (6,277)	8.5 (7,309)	10.5 (9,028)	
		Condition D	2.9 (2,494)	3.7 (3,181)	4.3 (3,697)	5.3 (4,557)	
	Heating	Condition A	7.9 (6,793)	9.7 (8,340)	11.1 (9,544)	13.3 (11,436)	
		Condition B	9.3 (7,997)	11.5 (9,888)	13.4 (11,522)	15.7 (13,500)	
Water Flow Rate	Cooling	Condition A	21.0	28.0	33.0	37.8	
		Condition B	15.9	21.2	25.0	28.6	
		Condition C	21.0	28.0	33.0	37.8	
		Condition D	13.4	17.8	21.0	24.1	
	Heating	Condition A	24.5	28.0	33.0	39.1	
		Condition B	21.0	28.0	33.0	37.8	
Head Loss	Cooling	Condition A	45.9	56.3	80.4	68.2	
		Condition B	28.4	31.5	44.0	38.9	
		Condition C	45.9	56.3	80.4	68.2	
		Condition D	20.4	23.5	31.3	26.4	
	Heating	Condition A	67.6	48.9	68.3	71.7	
		Condition B	49.6	48.9	68.3	68.3	
Power Input	Nominal	W	93	103	167	246	
Running Current	Nominal	A	0.88	0.89	1.39	1.88	
Fan	Type	-	Turbo Fan	Turbo Fan	Turbo Fan	Turbo Fan	
	Air Flow Rate (H / M / L)	m³/min	21.0 / 19.0 / 17.0	25.0 / 21.0 / 19.0	31.0 / 28.0 / 25.0	41.0 / 36.0 / 30.0	
Fan Motor	Type	-	BLDC	BLDC	BLDC	BLDC	
	Drive	-	CCW	CCW	CCW	CCW	
	Output	W x No.	40 x 1	156 x 1	156 x 1	136 x 1	
	FLA (Full Load Ampere)	A	0.88	0.89	1.39	1.88	
Dimensions	Net (W x H x D)	mm	840 x 204 x 840	840 x 246 x 840	840 x 246 x 840	840 x 288 x 840	
Weight	Net	kg	20.8	23.2	23.2	25.1	
	Shipping	kg	24.9	27.5	27.5	29.7	
Air Filter	Type	-	-	-	-	-	
Temperature Control	-	-	Microprocessor, Thermostat for cooling and heating				
Sound Absorbing / Thermal Insulation Material	-	-	Foamed polystyrene	Foamed polystyrene	Foamed polystyrene	Foamed polystyrene	
Protection Device	-	-	Fuse	Fuse	Fuse	Fuse	
Water Connecting Pipes	Inlet	-	BSPF G 3/4" (male)	BSPF G 3/4" (male)	BSPF G 3/4" (male)	BSPF G 3/4" (male)	
	Outlet	-	BSPF G 3/4" (male)	BSPF G 3/4" (male)	BSPF G 3/4" (male)	BSPF G 3/4" (male)	
Sound Pressure Level	Cooling (H / M / L)	dB (A)	51 / 48 / 46	51 / 47 / 43	55 / 53 / 51	57 / 53 / 50	
	Heating (H / M / L)	dB (A)	51 / 48 / 46	51 / 47 / 43	55 / 53 / 51	57 / 53 / 50	
Sound Power Level	Cooling (H / M / L)	dB (A)	57 / 55 / 52	59 / 54 / 51	63 / 61 / 58	65 / 61 / 57	
	Heating (H / M / L)	dB (A)	57 / 55 / 52	59 / 54 / 51	63 / 61 / 58	65 / 61 / 57	
Connecting Cable	Communication Cable (VCTF-SB)	mm² x cores	1.0 - 1.5	1.0 - 1.5	1.0 - 1.5	1.0 - 1.5	
	Name	-	PT-MCHW0	PT-MCHW0	PT-MCHW0	PT-MCHW0	
Decoration Panel #1 (Accessory)	Dimensions (W x H x D)	mm	950 x 35 x 950	950 x 35 x 950	950 x 35 x 950	950 x 35 x 950	
	Color	-	Morning fog	Morning fog	Morning fog	Morning fog	
	RAL Code	-	120-4	120-4	120-4	120-4	
	Name	-	-	-	-	-	
Decoration Panel #2 (Accessory)	Dimensions (W x H x D)	mm	-	-	-	-	
	Color	-	-	-	-	-	
	RAL Code	-	-	-	-	-	



High Head Drain Pump

High head drain pump automatically drains water up to a height of 700mm of drain-head height.

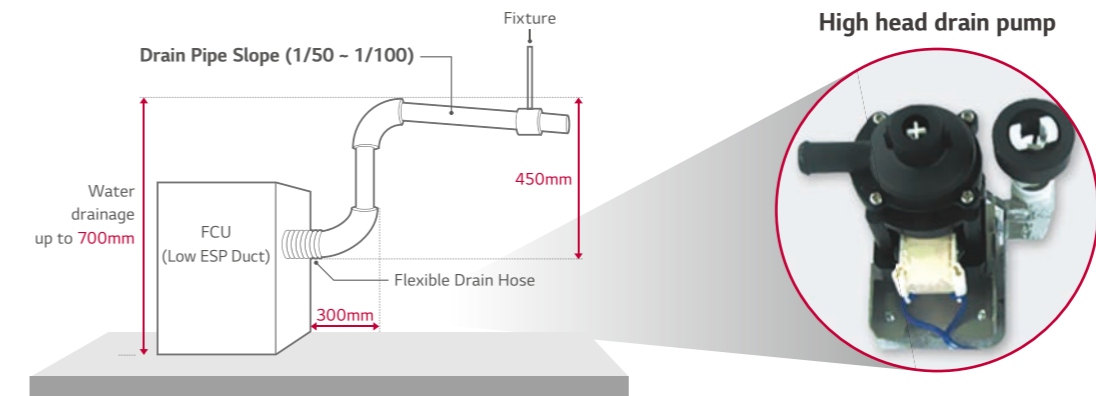

※ All of LG's FCU's have a high head drain pump built in.

Flexible Installation

LG's Low ESP Duct FCU allows air intake from the rear or the bottom sides according to requirements.

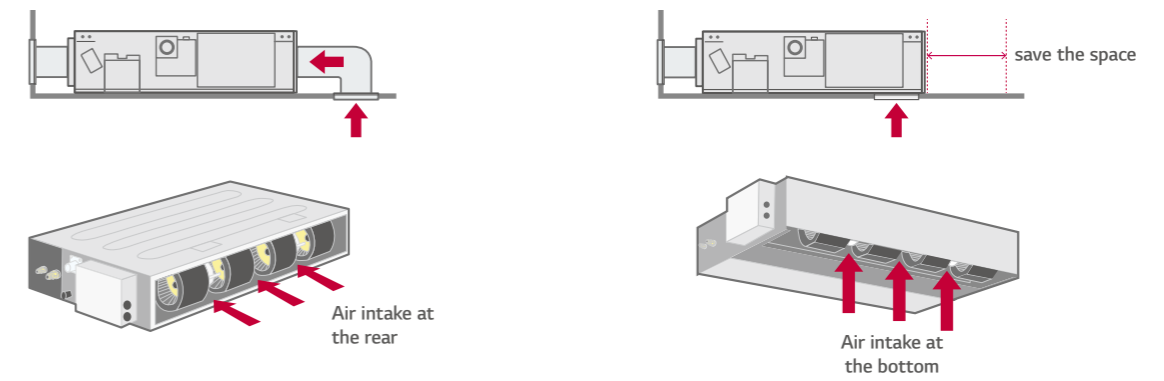

Various way for air intake

Quiet Operation

The noise level of Low EPS Ducts does not interfere with conversation at all.

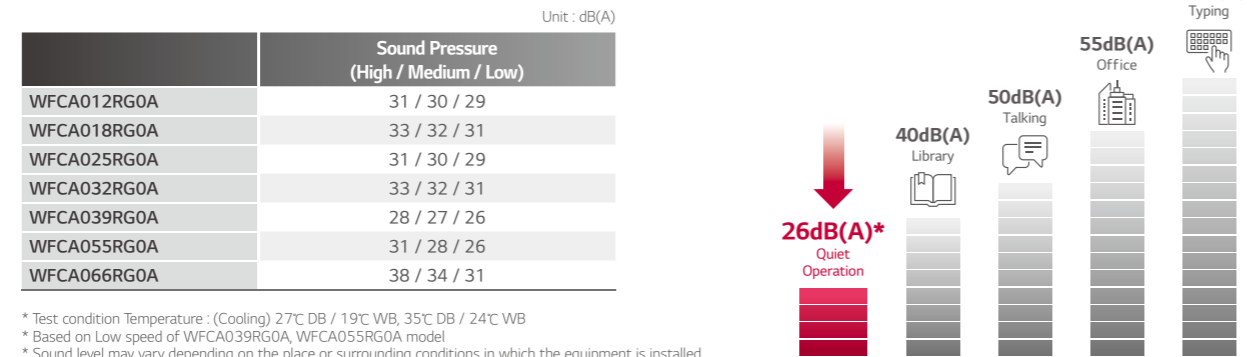

* Test condition Temperature : (Cooling) 27°C DB / 19°C WB, 35°C DB / 24°C WB
 * Based on Low speed of WFCA039RG0A, WFCA055RG0A model
 * Sound level may vary depending on the place or surrounding conditions in which the equipment is installed.

Two Thermistors Control

The indoor temperature can be checked using the thermistors in the remote controller as well as from the indoor unit. Two thermistors can check the optimal indoor air temperature for a more comfortable environment.

Compares temperatures sensed from different positions, and automatically selects the optimal temperature for users.

※ Need to connect the wired remote controller

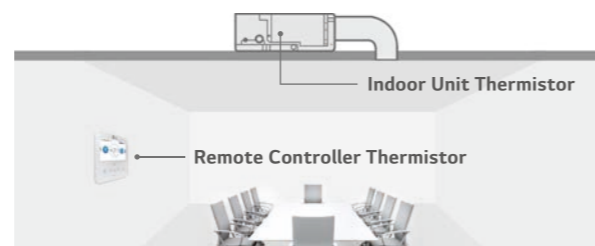

Easy Service & Maintenance

Service engineers don't need to open the whole panel for maintenance, since the panel is divided into 2 components; one for heat exchanger and the other for fans/motor. User can easily detach and re-attach the air filter in the available limited space.

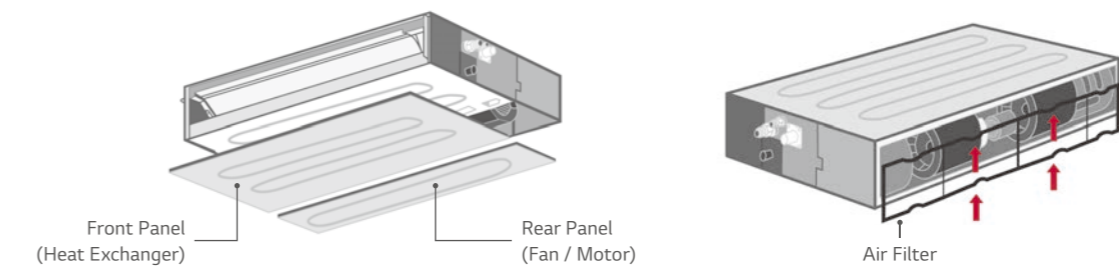

WFA012RG0A / WFA018RG0A
WFA025RG0A / WFA032RG0A

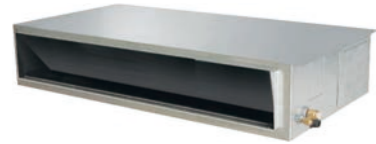

INDOOR			WFA012RG0A	WFA018RG0A	WFA025RG0A	WFA032RG0A
Power Supply	Ø, V, Hz		1, 220-230-240, 50	1, 220-230-240, 50	1, 220-230-240, 50	1, 220-230-240, 50
Running Current by Voltage	A		0.29-0.29-0.29	0.31-0.31-0.31	0.32-0.32-0.32	0.35-0.35-0.35
Capacity	Cooling	Condition A	1.3 (1,118)	1.8 (1,548)	2.5 (2,150)	3.2 (2,752)
		Condition B	1.1 (946)	1.5 (1,290)	2.1 (1,806)	2.7 (2,322)
		Condition C	1.2 (1,032)	1.6 (1,376)	2.2 (1,892)	2.8 (2,408)
		Condition D	0.7 (602)	0.9 (774)	1.3 (1,118)	1.6 (1,376)
	Heating	Condition A	2.0 (1,721)	2.8 (2,408)	3.2 (2,752)	3.8 (3,267)
		Condition B	2.1 (1,806)	3.0 (2,581)	3.6 (3,095)	4.4 (3,783)
Water Flow Rate	Cooling	Condition A	4.0	5.6	7.4	9.3
		Condition B	4.0	5.6	7.4	9.3
		Condition C	4.0	5.6	7.4	9.3
		Condition D	2.7	4.0	5.0	6.3
	Heating	Condition A	6.2	8.5	9.7	11.4
		Condition B	4.0	5.6	7.4	9.3
Head Loss	Cooling	Condition A	1.2	3.3	7.6	11.8
		Condition B	1.2	3.3	7.6	11.8
		Condition C	1.2	3.3	7.6	11.8
		Condition D	0.8	2.3	5.3	8.2
	Heating	Condition A	4.4	8.5	12.5	17.8
		Condition B	2.0	3.5	6.9	11.4
Power Input	Nominal	W	8	17	20	27
Running Current	Nominal	A	0.29	0.31	0.32	0.35
Fan	Type	-	Sirocco Fan	Sirocco Fan	Sirocco Fan	Sirocco Fan
	Air Flow Rate (H / M / L)	m³ / min	5.5 / 5.0 / 4.5	8.0 / 7.0 / 6.0	8.0 / 7.5 / 7.0	9.8 / 8.8 / 8.0
	External Static Pressure (Standard mode)	mmAq	0	0	0	0
	External Static Pressure (High mode)	mmAq	0	0	0	0
Fan Motor	Type	-	BLDC	BLDC	BLDC	BLDC
	Drive	-	CW	CW	CW	CW
	Output	W x No.	19 x 1	19 x 1	19 x 1 + 5 x 1	19 x 1 + 5 x 1
	FLA (Full Load Ampere)	A	0.29	0.31	0.32	0.35
Dimensions	Net (W x H x D)	mm	700 x 190 x 700	700 x 190 x 700	900 x 190 x 700	900 x 190 x 700
	Shipping (W x H x D)	mm	842 x 235 x 766	842 x 235 x 766	1,042 x 235 x 766	1,042 x 235 x 766
Weight	Net	kg	17.5	17.5	22.0	22.0
	Shipping	kg	21.9	21.9	26.9	26.9
Air Filter	Type	-	Pre Filter	Pre Filter	Pre Filter	Pre Filter
Temperature Control	-	-	Microprocessor, Thermostat for cooling and heating			
Sound Absorbing / Thermal Insulation Material	-	-	Foamed polystyrene	Foamed polystyrene	Foamed polystyrene	Foamed polystyrene
Protection Device	-	-	Fuse	Fuse	Fuse	Fuse
Water	Inlet	-	BSPF G 3/4" (male)	BSPF G 3/4" (male)	BSPF G 3/4" (male)	BSPF G 3/4" (male)
Connecting Pipes	Outlet	-	BSPF G 3/4" (male)	BSPF G 3/4" (male)	BSPF G 3/4" (male)	BSPF G 3/4" (male)
Sound Pressure Level	Cooling (H / M / L)	dB(A)	31 / 30 / 29	33 / 32 / 31	31 / 30 / 29	33 / 32 / 31
	Heating (H / M / L)	dB(A)	31 / 30 / 29	33 / 32 / 31	31 / 30 / 29	33 / 32 / 31
Sound Power Level	Cooling (H / M / L)	dB(A)	38 / 36 / 35	46 / 43 / 39	41 / 40 / 39	46 / 43 / 41
	Heating (H / M / L)	dB(A)	38 / 36 / 35	46 / 43 / 39	41 / 40 / 39	46 / 43 / 41
Connecting Cable	Communication Cable (VCTF-SB)	mm² x cores	1.0 - 1.5	1.0 - 1.5	1.0 - 1.5	1.0 - 1.5

WFA039RG0A / WFA055RG0A
WFA066RG0A

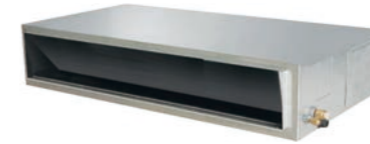

INDOOR			WFA039RG0A	WFA055RG0A	WFA066RG0A
Power Supply	Ø, V, Hz		1, 220-230-240, 50	1, 220-230-240, 50	1, 220-230-240, 50
Running Current by Voltage	A		0.26-0.37-0.37	0.36-0.44-0.44	0.70-0.71-0.71
Capacity	Cooling	Condition A	3.9 (3,353)	5.0 (4,299)	6.6 (5,675)
		Condition B	3.3 (2,837)	4.2 (3,611)	5.5 (4,729)
		Condition C	3.5 (3,009)	4.4 (3,783)	5.9 (5,073)
		Condition D	2.0 (1,721)	2.5 (2,150)	3.3 (2,837)
	Heating	Condition A	4.2 (3,611)	5.3 (4,557)	6.6 (5,675)
		Condition B	5.0 (4,299)	6.4 (5,503)	8.0 (6,879)
Water Flow Rate	Cooling	Condition A	13.3	17.0	21.7
		Condition B	13.3	17.0	21.7
		Condition C	13.3	17.0	21.7
		Condition D	9.0	11.5	14.7
	Heating	Condition A	13.3	17.0	21.7
		Condition B	13.3	17.0	21.7
Head Loss	Cooling	Condition A	21.7	39.0	53.9
		Condition B	21.7	39.0	53.9
		Condition C	21.7	39.0	53.9
		Condition D	5.7	27.2	37.6
	Heating	Condition A	30.3	48.3	71.7
		Condition B	30.3	48.3	71.7
Power Input	Nominal	W	29	44	81
Running Current	Nominal	A	0.37	0.44	0.71
Fan	Type	-	Sirocco Fan	Sirocco Fan	Sirocco Fan
	Air Flow Rate (H / M / L)	m³ / min	10.7 / 9.3 / 7.2	14.4 / 10.7 / 9.3	20.1 / 17.3 / 14.4
	External Static Pressure (Standard mode)	mmAq	0	0	0
	External Static Pressure (High mode)	mmAq	0	0	0
Fan Motor	Type	-	BLDC	BLDC	BLDC
	Drive	-	CW	CW	CW
	Output	W x No.	19 x 2	19 x 2	19 x 2
	FLA (Full Load Ampere)	A	0.37	0.44	0.71
Dimensions	Net (W x H x D)	mm	1,100 x 190 x 700	1,100 x 190 x 700	1,100 x 190 x 700
	Shipping (W x H x D)	mm	1,242 x 235 x 766	1,242 x 235 x 766	1,242 x 235 x 766
Weight	Net	kg	26.2	26.2	26.2
	Shipping	kg	30.7	30.7	30.7
Air Filter	Type	-	Pre Filter	Pre Filter	Pre Filter
Temperature Control	-	-	Microprocessor, Thermostat for cooling and heating		
Sound Absorbing / Thermal Insulation Material	-	-	Foamed polystyrene	Foamed polystyrene	Foamed polystyrene
Protection Device	-	-	Fuse	Fuse	Fuse
Water	Inlet	-	BSPF G 3/4" (male)	BSPF G 3/4" (male)	BSPF G 3/4" (male)
Connecting Pipes	Outlet	-	BSPF G 3/4" (male)	BSPF G 3/4" (male)	BSPF G 3/4" (male)
Sound Pressure Level	Cooling (H / M / L)	dB(A)	28 / 27 / 26	31 / 28 / 26	38 / 34 / 31
	Heating (H / M / L)	dB(A)	28 / 27 / 26	31 / 28 / 26	38 / 34 / 31
Sound Power Level	Cooling (H / M / L)	dB(A)	43 / 41 / 40	47 / 42 / 41	55 / 52 / 48
	Heating (H / M / L)	dB(A)	43 / 41 / 40	47 / 42 / 41	55 / 52 / 48
Connecting Cable	Communication Cable (VCTF-SB)	mm² x cores	1.0 - 1.5	1.0 - 1.5	1.0 - 1.5

244 - 317

CONTROL SOLUTIONS

INDIVIDUAL CONTROL / CENTRALIZED CONTROL / INTEGRATION DEVICE



The perfect choice for innovative building management

LG BECON HVAC SOLUTION

Innovative building management solution in your hands.
 Our optimized solutions provide integrated control for customers configuration of various equipment in building and intuitive interface to maximize efficiency of operations.



ENERGY SAVING



SMART MANAGEMENT



EASY EXPANDABILITY

SMART MANAGEMENT



Standard III Remote Controller



Premium Remote Controller



Wi-Fi Modem (with LG ThinQ)

EASY EXPANDABILITY



Modbus Gateway



ACP LonWorks



Dry Contact



ACP 5



ACS IO Module



ACU IO Module

ENERGY SAVING



PDI



AC Smart 5



AC Manager 5



AC Ez Touch

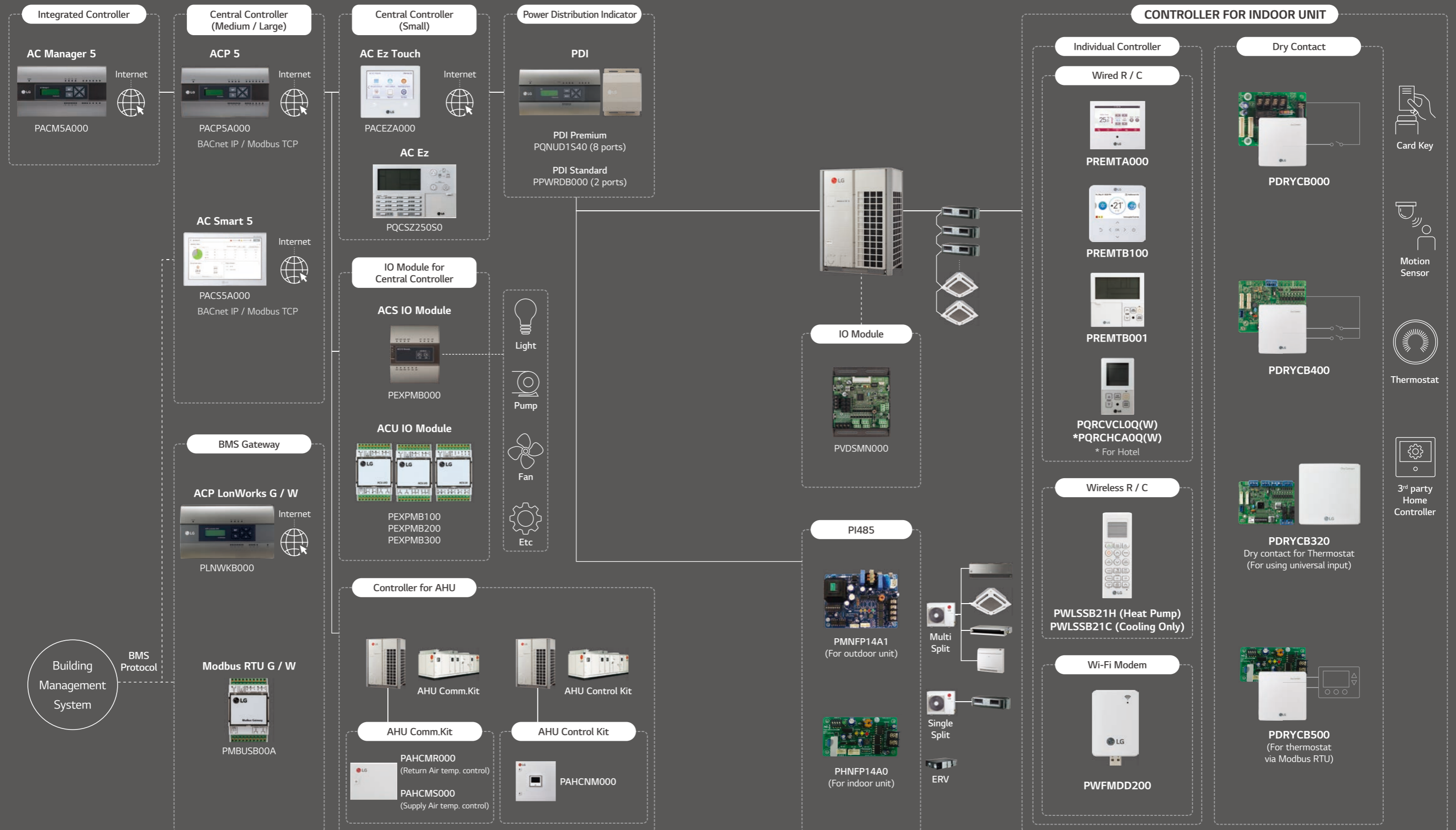

CONTROL SYSTEM ARCHITECTURE

LG BECON HVAC SOLUTION offers a diverse range of effective control solutions that satisfy specific needs of each building and its user scene. These control systems are equipped with user-friendly interface, flexible interlocking environment, energy management and smart individual controller for optimized controlling conditions and smart building management.





Feature Functions

Controller Name	Wired Remote Controller					Wireless Remote Controller	Wi-Fi Modem	
	Premium	Standard III	Standard II	Simple	Simple (Hotel)			
Model Name								
	PREMTA000 PREMTA000A PREMTA000B	PREMTB100 PREMTBB10	PREMTB001 PREMTBB01	PQRCVCLQ PQRCVCLQW	PQRCHCA0Q PQRCHCA0QW	PWLSSB21H (H/P) PWLSSB21C (C/O)	PWFMD200	
Basic	On / Off	<input type="radio"/>	<input type="radio"/>	<input type="radio"/>	<input type="radio"/>	<input type="radio"/>	<input type="radio"/>	
	Fan Speed Control	<input type="radio"/>	<input type="radio"/>	<input type="radio"/>	<input type="radio"/>	<input type="radio"/>	<input type="radio"/>	
	Temperature Setting	<input type="radio"/>	<input type="radio"/>	<input type="radio"/>	<input type="radio"/>	<input type="radio"/>	<input type="radio"/>	
	Mode	<input type="radio"/>	<input type="radio"/>	<input type="radio"/>	<input type="radio"/>	-	<input type="radio"/>	
	Auto Swing	<input type="radio"/>	<input type="radio"/>	<input type="radio"/>	<input type="radio"/>	<input type="radio"/>	<input type="radio"/>	
	Vane Control (Louver Angle)	<input type="radio"/>	<input type="radio"/>	<input type="radio"/>	<input type="radio"/>	<input type="radio"/>	<input type="radio"/>	
	E.S.P (External Static Pressure)	<input type="radio"/>	<input type="radio"/>	<input type="radio"/>	<input type="radio"/>	<input type="radio"/>	-	
	Electric Failure Compensation	<input type="radio"/>	<input type="radio"/>	<input type="radio"/>	<input type="radio"/>	<input type="radio"/>	-	
	Indoor Temperature Display	<input type="radio"/>	<input type="radio"/>	<input type="radio"/>	<input type="radio"/>	<input type="radio"/>	<input type="radio"/>	
	All Button Lock (Child Lock)	<input type="radio"/>	<input type="radio"/>	<input type="radio"/>	<input type="radio"/>	<input type="radio"/>	-	
	Schedule / Timer	Weekly - Yearly	Weekly - Yearly	Weekly	-	-	Sleep / On / Off	Weekly
	Wi-Fi AP Mode Setting	<input type="radio"/>	<input type="radio"/>	<input type="radio"/>	<input type="radio"/>	<input type="radio"/>	<input type="radio"/>	-
Advanced	Additional Mode Setting ¹⁾	<input type="radio"/>	<input type="radio"/>	<input type="radio"/>	-	-	-	
	Time Display	<input type="radio"/>	<input type="radio"/>	<input type="radio"/>	-	-	<input type="radio"/>	
	Humidity Display	<input type="radio"/>	<input type="radio"/>	-	-	-	-	
	Advanced Lock (Mode, Set point, Set point range, On / Off Lock)	Advanced Lock	Advanced Lock	-	-	-	-	
	Filter Sign	<input type="radio"/>	<input type="radio"/>	<input type="radio"/>	-	-	-	
	Energy Management ²⁾	<input type="radio"/>	<input type="radio"/>	<input type="radio"/>	-	-	-	
	Dual Set Point	<input type="radio"/>	<input type="radio"/>	-	-	-	-	
	Human Detection	-	<input type="radio"/>	-	-	-	-	
	Temp. Humidity Compensation	<input type="radio"/>	<input type="radio"/>	-	-	-	-	
	Air Purify Control	-	<input type="radio"/>	-	-	-	<input type="radio"/>	
Air Quality Level	-	<input type="radio"/>	-	-	-	-		
Dual Vane (6 Airflows mode)	-	<input type="radio"/>	-	-	-	<input type="radio"/>		
ETC	Operation Status LED	<input type="radio"/>	<input type="radio"/>	<input type="radio"/>	<input type="radio"/>	<input type="radio"/>	-	
	Wireless Remote Controller Receiver	<input type="radio"/> ³⁾	-	<input type="radio"/> ³⁾	<input type="radio"/> ³⁾	<input type="radio"/> ³⁾	-	
	Display	5 inch Color	4.3 inch Color	4.3 inch mono	2.6 inch mono	2.6 inch mono	2 inch mono	
	Size (W x H x D, mm)	137 x 121 x 16.5	120 x 120 x 16	120 x 121 x 16	70 x 121 x 16	70 x 121 x 16	51 x 153 x 26	48 x 68 x 14
	Black Control for Screen Saver	<input type="radio"/>	<input type="radio"/>	-	-	-	-	

※ ○ : Applied, - : Not Applied
 1) It might not be indicated or operated at the partial product.
 2) Centralized control (PACEZA000 / PACS5A000 / PACP5A000 / PLNWK000) and PDI (PQNUD1S40 / PPWRB000) should be installed for this function.
 3) For ceiling type duct
 Note :
 1. Indoor unit should have functions requested by the controller.
 2. If you need more detail, please refer to the manual of product. (<http://partnerlge.com> : Home > Doc.Library > Manual)



Design

- 4.3 inch color LCD / Intuitive GUI
- Seamless design / Touch button
- Humidity sensor embedded

Comfort & Air Purification

- CO₂ level monitoring (For ERV)
- Air quality level monitoring
- Air purify control

Energy Contents

- Power consumption monitoring
- Operation time monitoring
- Temperature setback
- Time limit control

Advanced Functions

- Comfort cooling setting
- Smart Load Control setting
- Outdoor unit low noise setting
- Defrost noise setting
- ODU capacity control
- Schedule functions



Touch Button

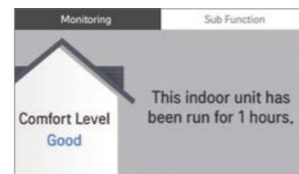
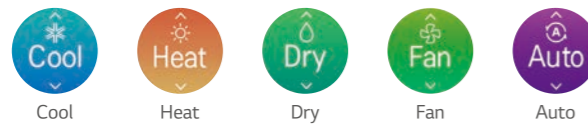

Comfort Level

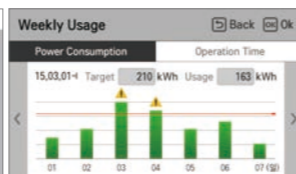

Energy Contents

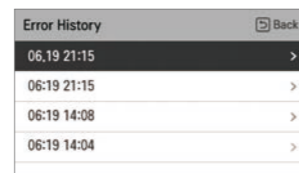

Error History

Standard III Wired Remote Controller

PREMTB100 (White) / PREMTBB10 (Black)

4.3 inch colored screen with modern design.



New Modern Design

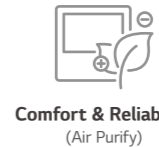

Comfort & Reliability (Air Purify)

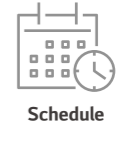

Schedule



Convenience

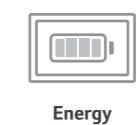

Energy Management



Interlocking

MODEL NAME	PREMTB100 / PREMTBB10
On / Off	○
Fan Speed Control	○
Temperature Setting	○
Mode	Cool / Heat / Dry / Fan / Auto
Additional Mode Setting ¹⁾	Energy-Saving Cooling / Robot Cleaning / Heater / Humidification / Comfort Cooling
Auto Swing	○
Vane Control (Louver direction)	○
E.S.P (External Static Pressure) ²⁾	○
Reservation	Simple / Sleep / On & Off timer / Weekly / Yearly / Holiday
Time Display	○
Electric Failure Compensation	○
Lock	All / On & Off / Mode / Set temperature range
Filter Sign	○ (Remain time + Alarm)
Energy Management	Check Energy Usage ³⁾ / Check Operation Time / Target Setting (Energy, Operation Time) / Time Limit Operation / Alarm Popup / Initialization Usage Data
Operation Status LED	○
Air Purify Control ⁴⁾	○
Air Quality Level ⁴⁾	○
Indoor Temperature Display	○
Indoor Humidity Display	○
Human Detection	○
Display	4.3 inch TFT color LCD (480 x 272)
Size (W x H x D, mm)	120 x 120 x 16
Black Light for Screen Saver	○
Home Leave	2 set points control

※ ○ : Applied, - : Not Applied
 1) The function is available in some product. (Refer to the product data Book).
 2) This function is available for duct type.
 3) This function requires PDI (PQNUD1S40 / PPWRDB000) to be installed.
 4) This function is available for indoor units that provide corresponding function.
 Note:
 1. Indoor unit needs to have functions requested by the controller.
 2. 2 set points control works normally with MULTI V Heat Recovery and Single Split Heat Pump. But in case of MULTI V Heat Pump, It may not work properly.

Standard III Wired Remote Controller

Air Quality Level Display

Easy check for indoor air quality

· PM10 / PM2.5 / PM1.0 · Status / Monitoring



CLASSIFICATION	GOOD	MODERATE	UNHEALTHY	POOR
* PM10 (µg / m3)	0 - 54	55 - 154	155 - 254	255 -
* PM2.5 (µg / m3)	0 - 12	13 - 35	36 - 55	56 -
* PM1.0 (µg / m3)	0 - 12	13 - 35	36 - 55	56 -

Note : Display color may change depending on the region / country.
 This function is available for indoor units that provide corresponding function.
 * PM (Particulate matter)
 - PM10 : Coarse Particulate matter / PM2.5 : Fine Particulate matter / PM1.0 : Ultra Fine Particulate matter
 - PM designated as a carcinogen as like an asbestos, widely known as carcinogen.
 If the dust diameter is under 10 micrometers, it is PM10. And under 2.5 micrometers, it's PM2.5.

Environment Display

Displaying environment information for the more user comfort

Temperature / Humidity / Comfort level / CO₂ concentration

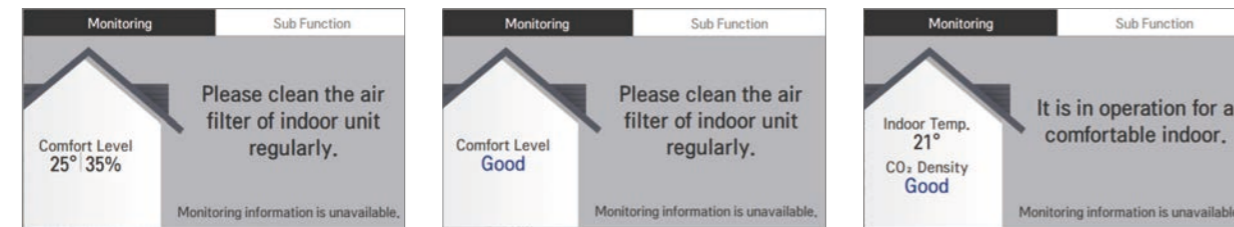

Dual Set Point

Auto changeover for convenience

- Indoor unit will keep the indoor temperature within the range of dual set point by automatically switching the unit operation.

Setback for energy savings and comfort

- In the user's absence, the room temperature will remain between two set points rather than switching off, providing quick comfort when the mode is changed to 'occupied'.

※ This function is for Heat Recovery system or Single heat pump. Otherwise it is not guaranteed.

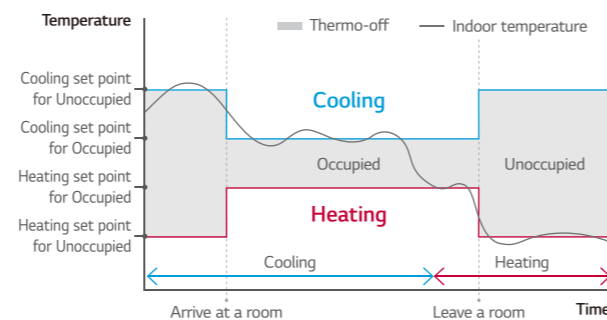

Energy Savings

Energy Management

- Energy Monitoring & Alarm
 Real-time and day / week / month / year energy usage monitoring is possible. In addition, it can set target for energy usage and operation time, and alarm will be displayed when exceeded.

※ PDI (PQNUD1S40 / PPWRDB000) is required.

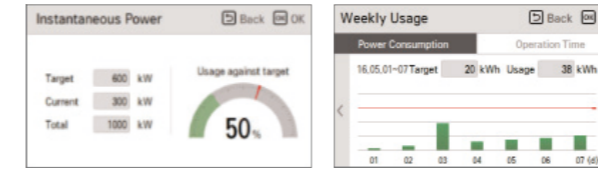

Instantaneous Power Check Energy Usage Target Setting

Time Limit Control

- Monitoring the unit's continuous running time.
 And prevent the wasting energy by turning the unit off automatically.



Schedule Function

Simple Schedule Status

Standard III remote controller provides clock type daily schedule.

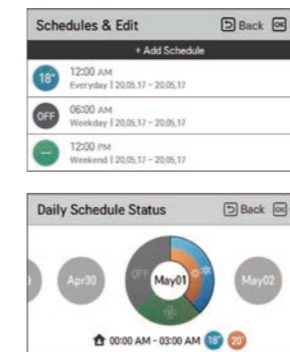

Exception Day Settings

Possible to set up exceptional date on regular schedule.

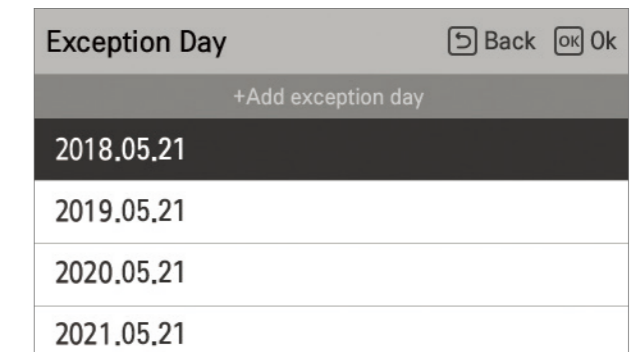

External Device On / Off

External Equipment Control

User can control the external equipment through additional contact signal output.

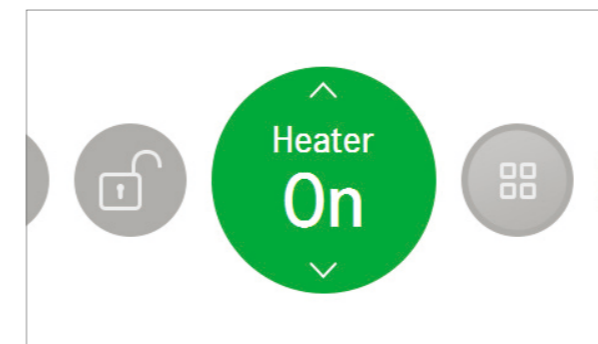

Customized Interlocking Control

User can create a automatic control pattern. For example, turning the temperature drops below or rises above a certain temperature.

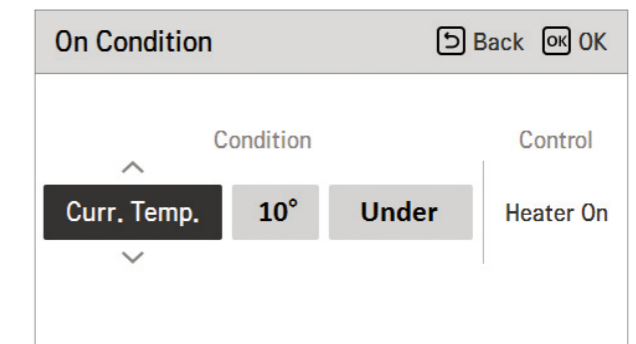

Premium Wired Remote Controller



Full Touch Screen



PREMTA000 ¹⁾ / PREMTA000A ²⁾ / PREMTA000B ³⁾

5 inch full touch screen with a premium design.



* Supported languages list
 1) English / Portuguese / Spanish / French
 2) English / Italian / Russian / Chinese
 3) English / German / Polish / Czech

MODEL NAME	PREMTA000 / PREMTA000A / PREMTA000B
On / Off	○
Fan Speed Control	○
Temperature Setting	○
Mode	Cool / Heat / Dry / Fan / Auto
Additional Mode Setting ¹⁾	Energy-Saving Cooling / Robot Cleaning / Heater / Humidification
Auto Swing	○
Vane Control (Louver direction)	○
E.S.P (External Static Pressure) ²⁾	○
Reservation	Simple / Sleep / On / Off / Weekly / Yearly / Holiday
Time Display	○
Electric Failure Compensation	○
Child Lock	○
Filter Sign	○ (Remain time + Alarm)
Energy Management	Check Energy Usage ³⁾ / Check Operation Time / Target Setting (Energy, Operation Time) / Time Limit Operation / Alarm Popup / Initialization Usage Data
Operation Status LED	○
Indoor Temperature Display	○
Wireless Remote Controller Receiver	○ ⁴⁾
Display	5 inch TFT color LCD (480 x 272)
Size (W x H x D, mm)	137 x 121 x 16.5
Black Light for Screen Saver	○
Home Leave	2 set points control

※ ○ : Applied, - : Not Applied
 1) It might not be indicated or operated at the partial product.
 2) This function is available for duct type.
 3) This function requires PDI (PQNUD1S40 / PPWRDB000) to be installed.
 4) For ceiling type ducted unit.
 Note : 1. Indoor unit needs to have functions requested by the controller
 2. 2 set points control works normally with MULTI V Heat Recovery and Single Split Heat Pump. But in case of MULTI V Heat Pump, It may not work properly

Easy Energy Management

- Check the operation hour or electricity usage
- Comparison of usage by year
- Set the target usage and time

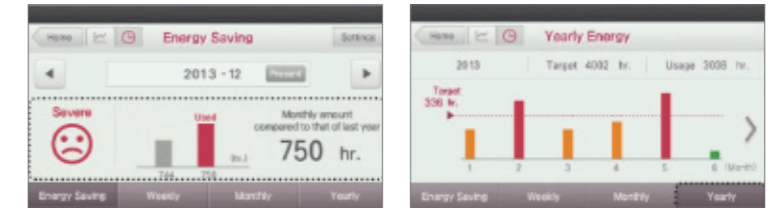

Easy Scheduling

- Daily, Weekly, Yearly schedule function
- Schedule pattern setting
- Schedule copy



Dual Set Point

- Auto changeover switching the operation mode automatically
- Setback (Leave Home) Changing status by occupied / unoccupied

* This function is only for Heat Recovery system and Single heat pump.

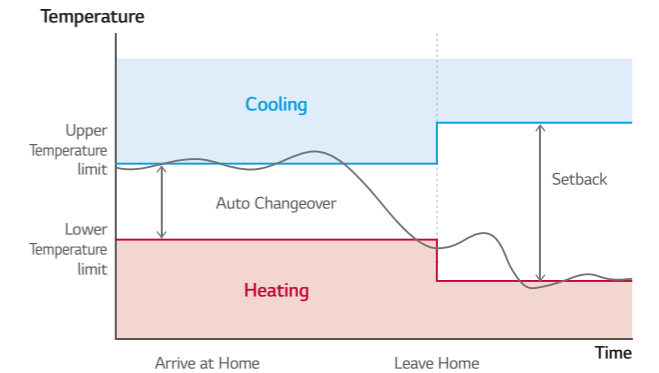

Group Control

- Max. 16 Indoor units by one remote controller

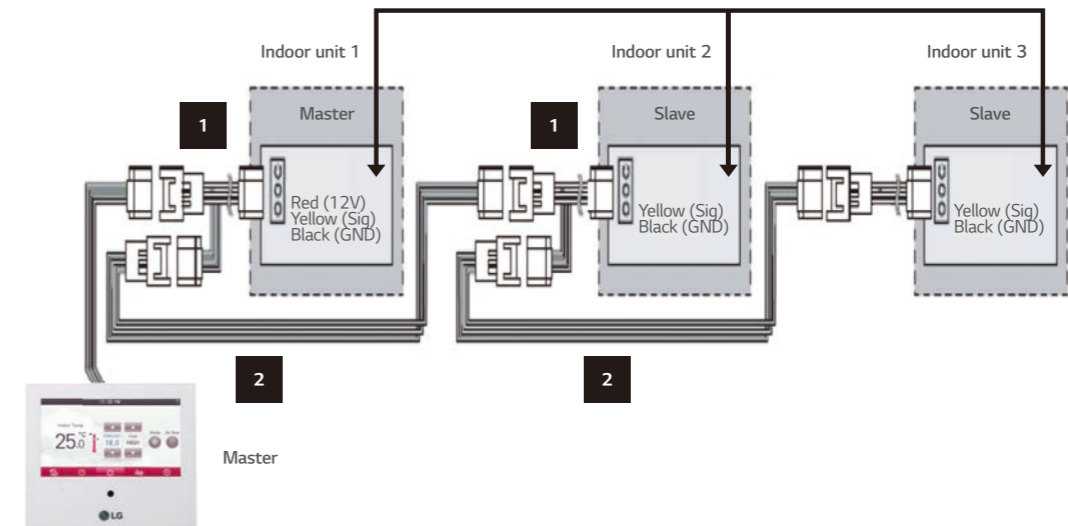

Standard II Wired Remote Controller

PREMTB001 / PREMTBB01

Providing easy control of one or a group of indoor units with various functions.



Features & Benefits

- Wired remote controller that can implement various functions such as scheduling or filter alert.

MODEL NAME	PREMTB001 / PREMTBB01
On / Off	○
Fan Speed Control	○
Temperature Setting	○
Mode	Cool / Heat / Dry / Fan / Auto
Additional Mode Setting	Energy-Saving Cooling / Robot Cleaning / Heater / Humidification
Auto Swing	○
Vane Control (Louver direction)	○
E.S.P (External Static Pressure)	○
Reservation	Simple / Sleep / On / Off / Weekly / Holiday
Time Display	○
Electric Failure Compensation	○
Child Lock	○
Filter Sign	○ (Remain time + Alarm)
Operation Status LED	○
Indoor Temperature Display	○
Wireless Remote Controller Receiver	○ ¹⁾
Size (W x H x D, mm)	120 x 121 x 16
Black Light	○
Power Consumption Monitoring	○ ²⁾
Check Model Information	○

※ ○ : Applied, - : Not Applied
 1) For ceiling type ducted unit
 2) This function requires PDI (PQNUD1S40 / PPWRDB000) to be installed.
 Note : Indoor unit needs to have functions requested by the controller.

Simple Wired Remote Controller

PQRCVLOQW (White) / PQRCVLOQ (Black) / PQRCHCA0QW (White) / PQRCHCA0Q (Black)

A simple way to control office or hotel systems in a compact design.



Features & Benefits

- Small remote control with minimal functionality.

MODEL NAME	PQRCVLOQW / PQRCVLOQ	PQRCHCA0QW / PQRCHCA0Q
On / Off	○	○
Fan Speed Control	○	○
Temperature Setting	○	○
Mode	Cool / Heat / Dry / Fan / Auto	-
Auto Swing	○	○
Vane Control (Louver direction)	○	○
E.S.P (External Static Pressure)	○	○
Electric Failure Compensation	○	○
Child Lock	○	○
Indoor Temperature Display	○	○
Wireless Remote Controller Receiver	○ ¹⁾	○ ¹⁾
Size (W x H x D, mm)	70 x 121 x 16	70 x 121 x 16
Black Light	○	○

※ ○ : Applied, - : Not Applied
 1) For ceiling type ducted unit
 Note : Indoor unit needs to have functions requested by the controller.

Wireless Remote Controller

PWLSSB21H (Heat Pump), PWLSSB21C (Cooling Only)

Handy and portable wireless type.



Features & Benefits

- Easy to use while moving.
- Main functions are available.

MODEL NAME	PWLSSB21H (H/P), PWLSSB21C (C/O)
On / Off	○
Fan Speed Control	○ ¹⁾
Temperature Setting	○
Mode	Cool / Heat / Dry / Fan / Auto
Additional Mode Setting	Air Purification / Energy-Saving Cooling / Robot Cleaning / Auto Dry
Auto Swing	○
Vane Control (Louver direction)	○
Reservation	Sleep / On / Off
Time Display	○
Indoor Temperature Display	○
Sleep Mode Auto	Max. 7 hours
Size (W x H x D, mm)	51 x 153 x 26

※ ○ : Applied, - : Not Applied
 1) For some products, you can use "slow" fan speed function.

Wi-Fi Modem

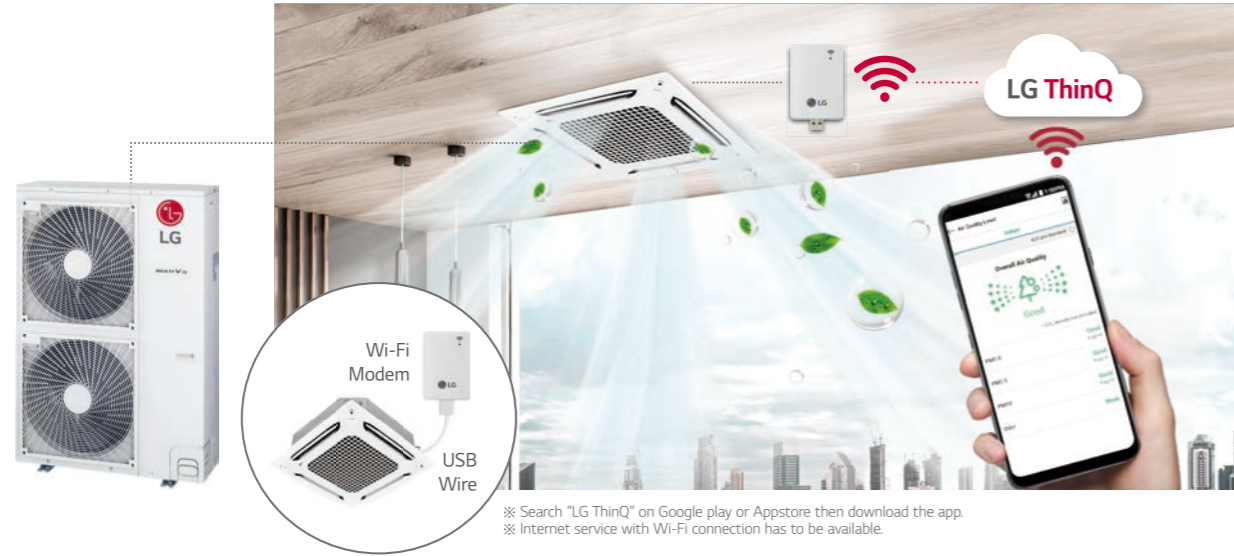

※ Search "LG ThinQ" on Google play or Appstore then download the app.
 ※ Internet service with Wi-Fi connection has to be available.

PWFMDD200

Control conditioners by using internet devices as Android or iOS smartphones.



Features & Benefits

- User can enjoy anytime, anywhere access with Wi-Fi equipped device through LG's ThinQ mobile app.
 - This allows the user to access the unit remotely to switch unit on or off before or after leaving the vicinity.
 - LG's exclusive Home Appliances control app (LG ThinQ) is available.
 - Simple operation for various functions.
- On / Off
 - Operation Mode
 - Current / Set Temperature
 - Fan Speed
 - Vane Control ¹⁾
 - Reservation (Sleep, Weekly On / Off)
 - Energy Monitoring ²⁾
 - Filter Management
 - Error Check
 - Air Purify ³⁾

MODEL NAME	PWFMDD200
Size (W x H x D, mm)	48 x 68 x 14
Interfaceable Products	System Air Conditioner ³⁾
Connection Type	Indoor unit 1:1
Communication Frequency	2.4 GHz
Wireless Standards	IEEE 802.11b / g / n
Mobile Application	LG ThinQ (Android v4.1(Jellybean) or higher, iPhone iOS 9.0 or higher)
Optional Extension Cable	PWYREW000 (10m extension)

1) Vane Control may not be possible according to the type of Indoor unit.
 2) LG Centralized controller and PDI installation is required for this function.
 3) For the compatibility with Indoor unit, please contact regional LG office.
 Note :
 1. Functionality may be different according to each IDU model.
 2. User interface of application shall be revised for its design and contents improvement.
 3. Application is optimized for smartphone use, so it may not be well functioning with tablet devices.

Installation Scene

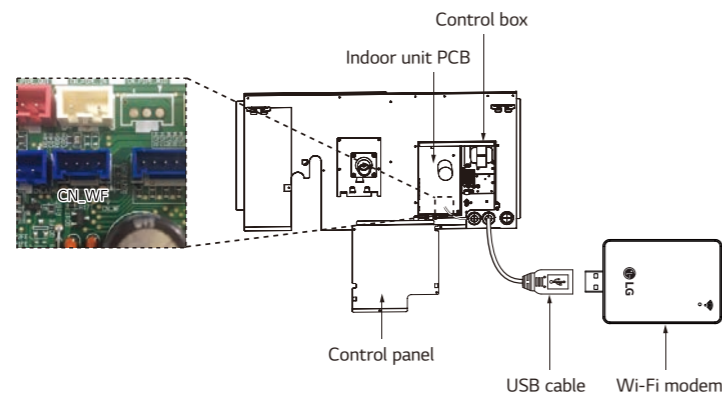

※ The Wi-Fi communication distance and reliability may vary due to the type of Wi-Fi router and the installation environment, Please refer to the manual.

LG ThinQ Connectivity

Connection (Pairing) Order

- 1 Make LG account on LG ThinQ (Application) and login.
- 2 Select the installed product and set AP (Access Point) mode by wired / wireless remote controller.
- 3 Select the Wi-Fi network that will be used and insert the passwords.
- 4 Product registration progress is completed.

* 5GHz networks may not be supported.

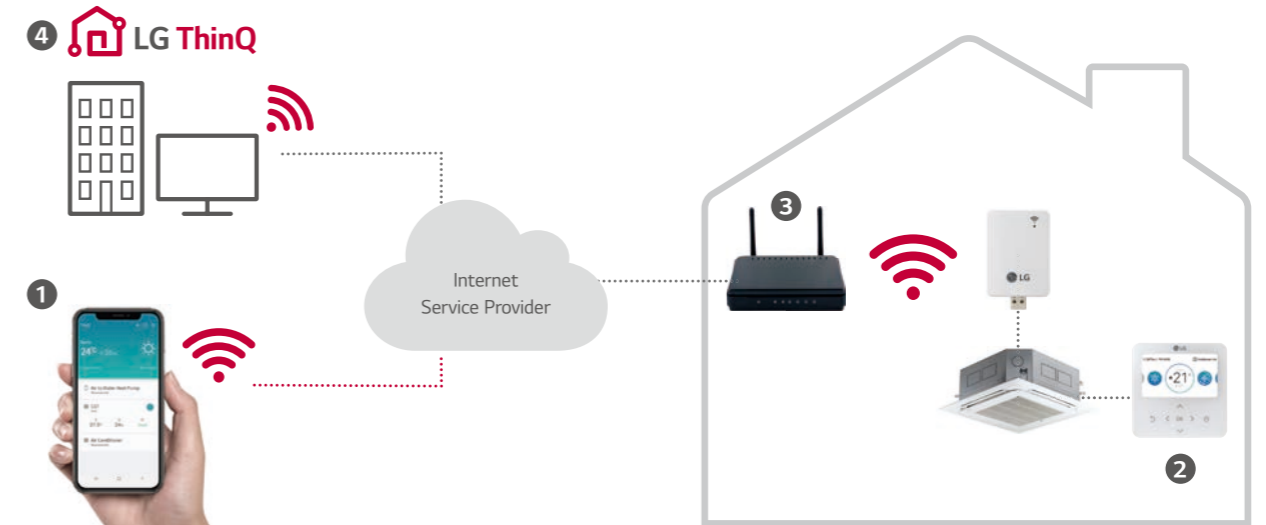

LG ThinQ Mobile App

Simple operation for various functions

On, Off, Current Temp., Mode, Set Temp.



<Day>

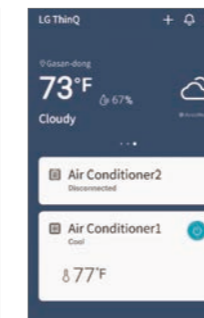

<Night>

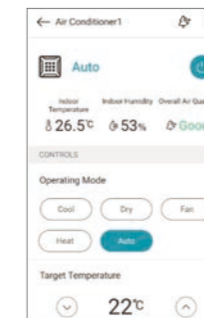

Vane Control

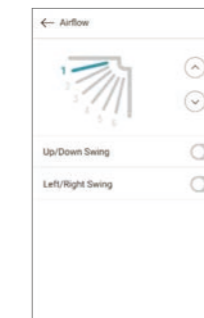

Air Purify

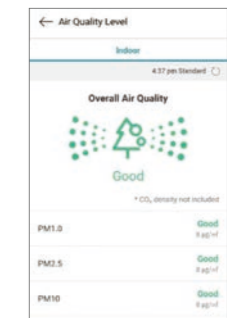

Easy Management

Reservation

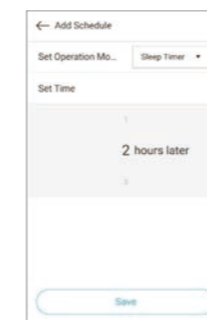

Energy Monitoring



Smart Diagnosis



Filter Management





Feature Functions

Controller Name		AC Ez	AC Ez Touch	AC Smart 5 ⁶⁾	ACP 5 ⁶⁾	ACP LonWorks	AC Manager 5 ⁷⁾	
Model Name								
		PQCSZ250S0	PACEZA000	PACS5A000	PACP5A000	PLNWK000	PACM5A000	
Product	DO	-	-	2	4	2	-	
	DI	-	1	2	10	2	-	
	Max. Connectable No.	IDUs	32	64	128	256	64	8,192
		ERV	32	64	128	256	64	8,192
		A / C + ERV	32	64	128	256	64	8,192
		AHU	-	-	16	16	16 ⁵⁾	16 x 32
		Chiller	-	-	5 Optional ⁴⁾	10 Optional ⁴⁾	-	10 x 32
Commercial Air Purifier ¹⁾	-	-	64	128	-	128 x 32		
Compatibility	Air Conditioner	○ ³⁾	○	○	○	○	○	
	Ventilation (ERV / ERV DX)	○ ⁴⁾	○	○	○	○	○	
	Heating	-	○	○	○	○	○	
	AHU	-	-	○	○	○	○	
	Chiller	-	-	○ ⁵⁾	○ ⁵⁾	-	○	
	Commercial Air Purifier ¹⁾	-	-	○ ⁵⁾	○ ⁵⁾	-	○	
	ACS IO	-	-	○ ⁵⁾	○ ⁵⁾	○ ⁵⁾	○	
Additional Function	Add Drawing	-	-	○ ⁵⁾	○ ⁵⁾	○ ⁵⁾	○	
	Group Management	-	○	○ ⁵⁾	○ ⁵⁾	○ ⁵⁾	○	
	Auto Changer Over	-	○	○ ⁵⁾	○ ⁵⁾	○ ⁵⁾	○	
	Set Back	-	○	○ ⁵⁾	○ ⁵⁾	○ ⁵⁾	○	
	Dual Setpoint	-	○	○	○	○ ⁵⁾	○	
	Change Alarm	-	Filter	Filter	Filter	Filter	Filter	
	Indoor Unit Lock	○ ⁸⁾	○	○	○	○ ⁵⁾	-	
	Cycle Monitoring	-	-	○	○	○ ⁵⁾	○	
	Air Purify	-	○ ⁵⁾	○ ⁵⁾	○ ⁵⁾	-	○	
Schedule		○	○	○ ⁵⁾	○ ⁵⁾	○ ⁵⁾	○	
Auto Control	Peak Control	Energy & Priority Control	-	○	○	○	○ ⁵⁾	○
		Outdoor Unit Capacity Control	-	-	○ ⁵⁾	○ ⁵⁾	○ ⁵⁾	○
	Time limit control	-	-	○ ⁵⁾	○ ⁵⁾	○ ⁵⁾	○	
	Interlocking	-	-	○ ⁵⁾	○ ⁵⁾	○ ⁵⁾	○	
Energy Navigation		-	-	○ ⁵⁾	○ ⁵⁾	-	○	
Energy Report	Power	-	○	○	○	○ ⁵⁾	○	
	Gas	-	-	○	○	○ ⁵⁾	○	
	Run time	-	-	○ ⁵⁾	○ ⁵⁾	○ ⁵⁾	○	
	Save to PC / USB (Excel)	-	-	PC / USB ⁵⁾	PC	PC	PC	
Trend Reporting		-	-	-	-	-	○	
History	Report (Control / Error)	-	Error	○ ⁵⁾	○ ⁵⁾	○ ⁵⁾	○	
	Send Email	-	-	○ ⁵⁾	○ ⁵⁾	○ ⁵⁾	○	
	Save to PC / USB (Excel)	-	-	PC / USB ²⁾	PC ²⁾	○ ⁵⁾	PC ²⁾	
etc	Summer Time	-	○	○ ⁵⁾	○ ⁵⁾	○ ⁵⁾	○	
	Outdoor Unit Oil-Return Operation	-	-	○ ⁵⁾	○ ⁵⁾	○ ⁵⁾	-	
	User Authority	-	Password	○ ⁵⁾	○ ⁵⁾	○ ⁵⁾	○	
	PC Access	-	○	○ ⁵⁾	○ ⁵⁾	○ ⁵⁾	○	

※ ○ : Applied, - : Not Applied
 1) The Commercial Air purifier must additionally install PI485 (PHNFP14A0).
 2) Save to PC / USB function will be available from 2021.
 3) Except for some feature (Individual lock, Limit temp, etc.)
 4) Except for some feature (User mode, additional function, etc.)
 5) This function is not applied for BMS points.
 6) Without additional device, ACP 5 and AC Smart 5 provide BACnet IP and Modbus TCP interface for BMS.
 7) ACP 5 or AC Smart 5 is required.
 8) Hard Lock

AC EZ Touch

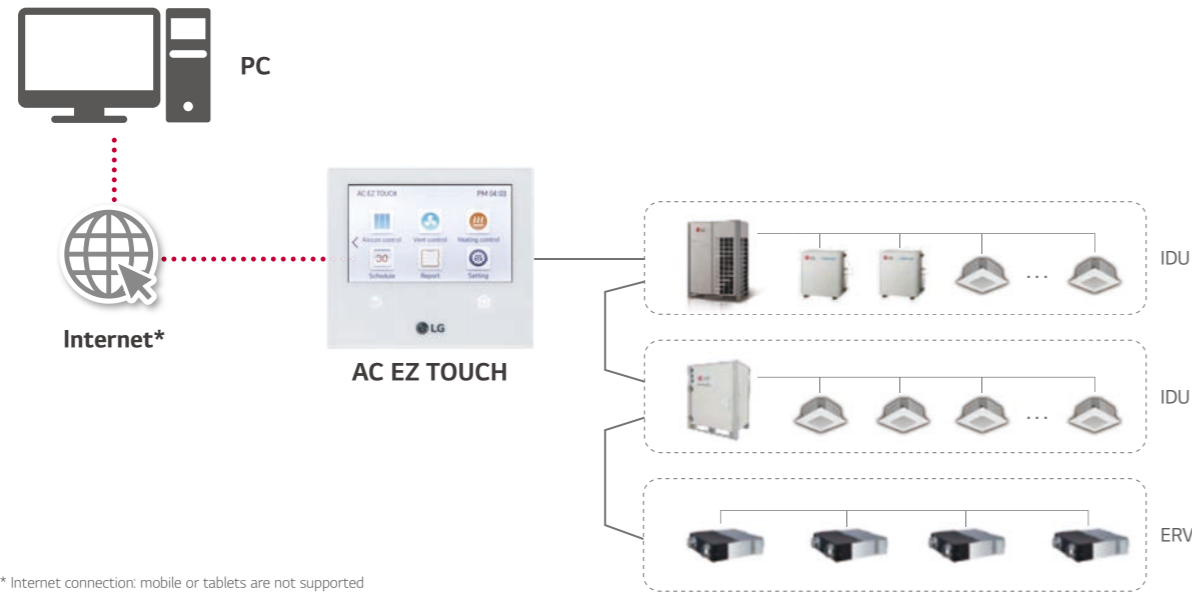

* Internet connection: mobile or tablets are not supported

PACEZA000

Smart management with 5 inch touch screen for small site.



MODEL NAME	PACEZA000
Size (W x H x D, mm)	137 x 121 x 25
Interfaceable Products	MULTI V / ERV / ERV DX / Hydro Kit / THERMA V
Maximum number of units	64
Individual / Group Control	On & Off / Mode / Temperature / Fan speed
Individual Controller Lock	Temperature / Mode / Fan speed / All
Error Check	○
Slave Mode (Interlocking with higher level controller)	○
Schedule	Weekly / Monthly / Yearly / Exception day
Remote Access	By client S/W (Neither Android nor IOS are supported)
Emergency Stop & Alarm Display	○
Power Consumption Monitoring (with PDI)	○
Auto Changeover / Setback	○
Temperature Limit	○
Operation History	Error record
ODU Low Noise ¹⁾	○
Daylight Saving Time	○
External IO Port	DI 1
IPv6 Support	○
Air Purify Control	○
Air Quality Level	○

※ ○ : Applied, - : Not Applied
 1) It is only available in some products.

PC Access

Users can control each space efficiently through PC access.



* IPv6 supported
 - Open port 80 & 9300
 - Fix public IP is mandatory. Router configuration of NAT is required.

Energy Statistics (with PDI)

Statistics of operational status (Time, Power consumption) are provided to help make intelligent system operation decisions.

Energy		
2020.2.8 ~ 2020.3.19		
Today Week Month		
Name	Usage(kWh)	Accumulated(kWh)
Group1	110	3021
Group2	150	6186
Group3	130	4267
Group4	120	7614

Energy Mode

When using energy mode function, operation Modes from cooling to fan or heating to off mode by force. (It is available only for operating indoor unit)

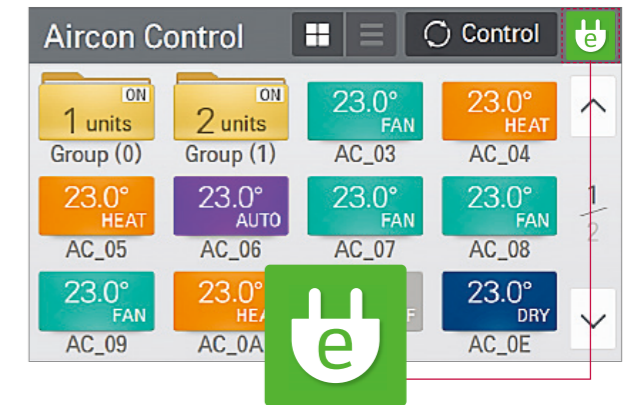

Air Purify Control & Monitoring

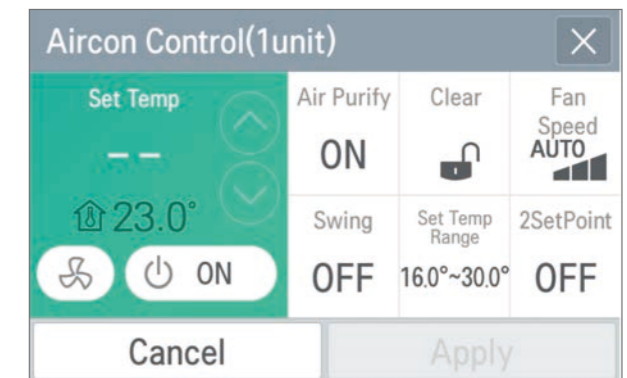
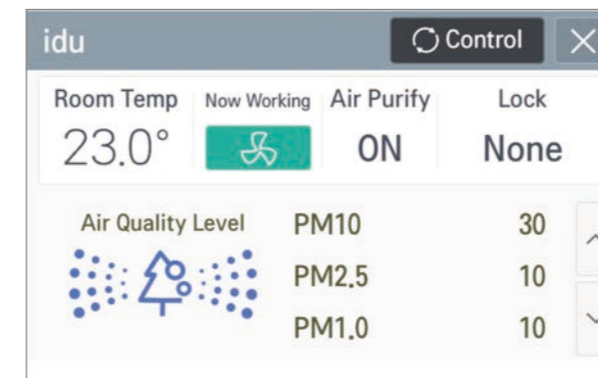

AC EZ Touch

Alarm Indicator

It shows errors and alarm information. Users can respond immediately according to alarm indicator therefore HVAC system is monitored consistently.

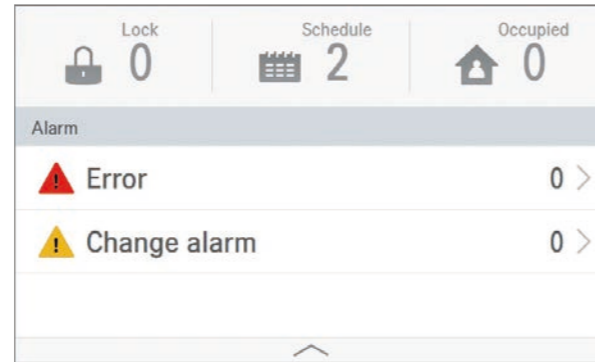

Schedule

Schedule control allows user to set the events in advance to maximize system performance. Also, by blocking unnecessary operation, it prevents a waste of energy.

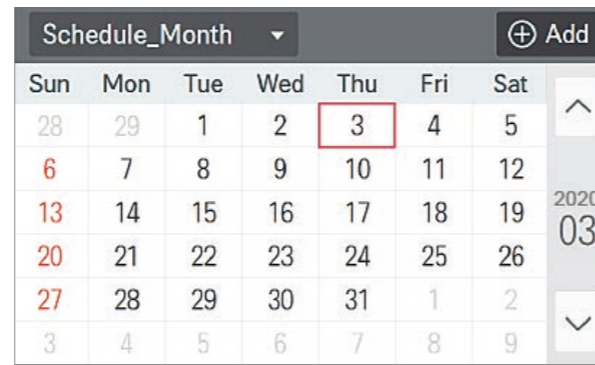

Group / Individual Control

User can control each indoor unit individually or by group by simply clicking each unit on control screen.

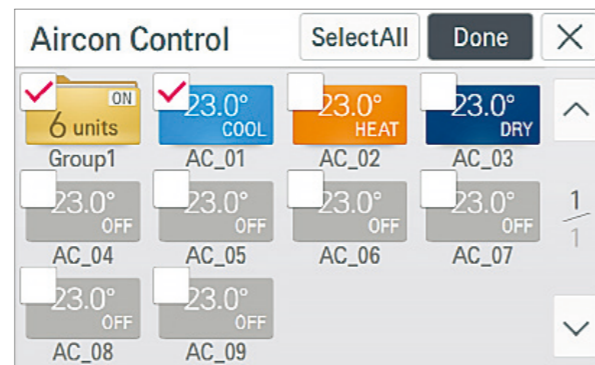

AC EZ

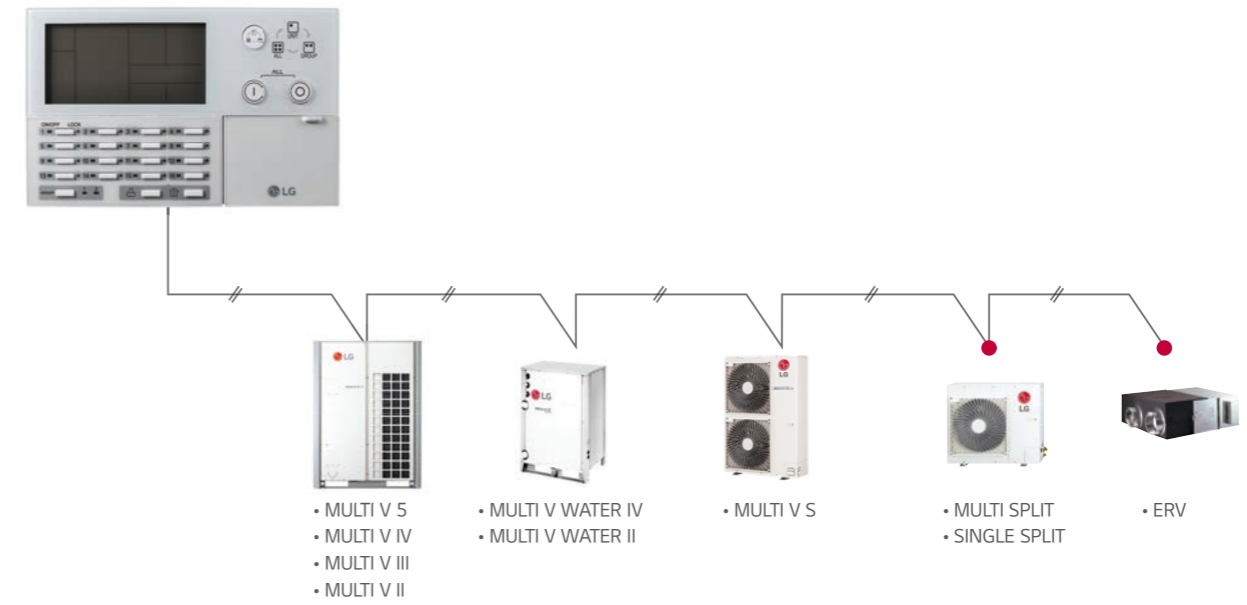

• Appropriate PI485 should be used according to PDB.

PQCSZ250S0

Easy to manage up to 32 indoor units, including ERV with simple interface.



Features & Benefits

- 32 indoor units control
- Weekly Schedule
- Individual / Group Control

MODEL NAME	PQCSZ250S0
Size (W x H x D, mm)	190 x 120 x 20
Interfaceable Products	MULTI V / ERV / ERV DX
Display	LED / LCD Display
Power	DC12V, 1A
Maximum number of units	32
Individual / Group Control	On & Off / Mode / Temperature / Fan speed
Individual Controller Lock	All
Error Check	○
Slave Mode (Interlocking with higher level controller)	○
Schedule	Weekly

※ ○ : Applied, - : Not Applied

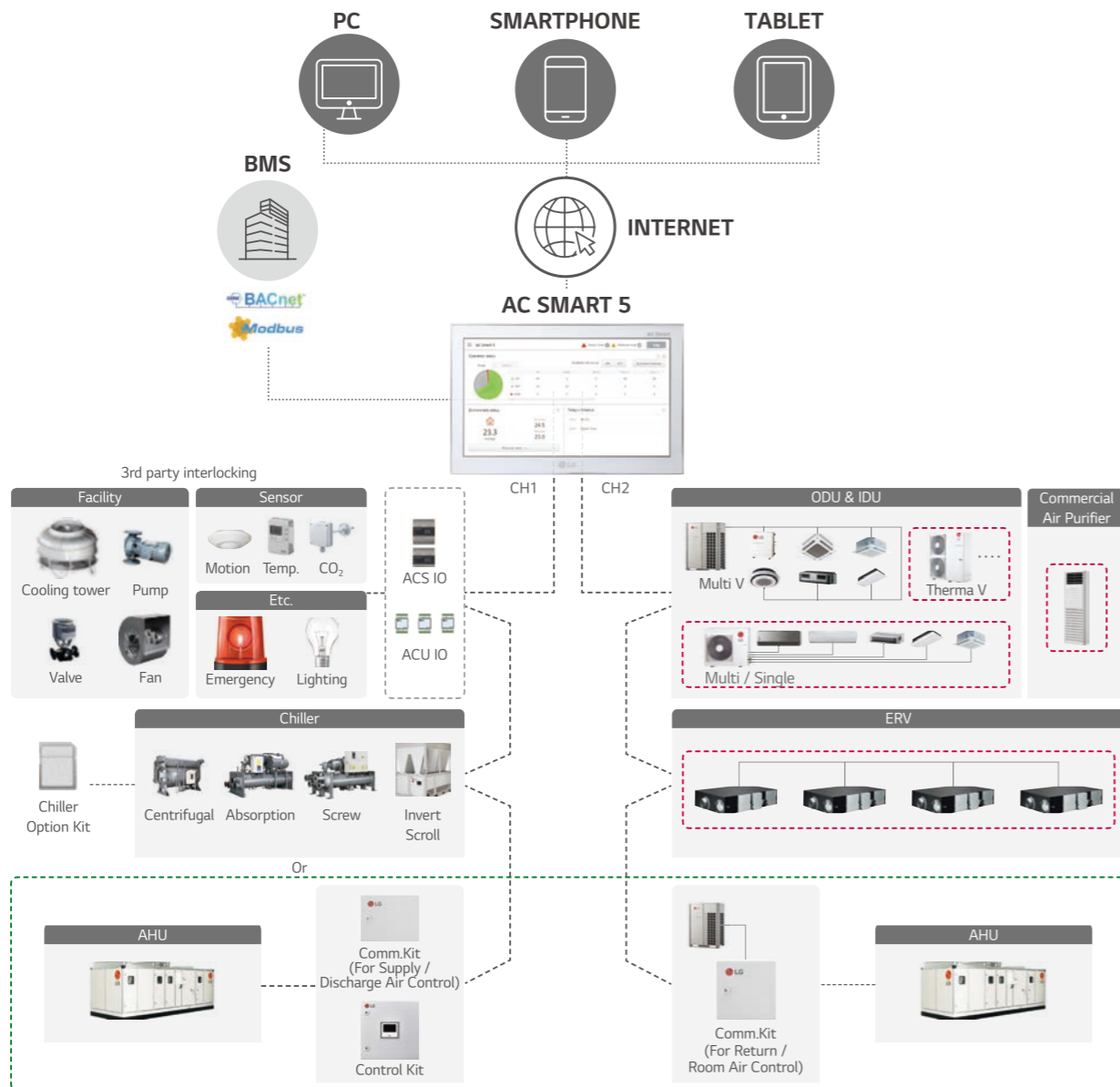

⚡ According to CH1 setting, normal ODU can be connected to CH1.
(Flexible wiring design with 2 ports)
⚡ Appropriate P1485 should be used according to PDB (Product Data Book).
⚡ For details, refer to the product PDB or manual.

AC Smart 5

PACSSA000

10-inch touch screen with HTML5 GUI (Graphic User Interface) for easy control.



Max. 128 IDU control



Schedule



Map view
(Visual navigation)



Energy monitoring



Air Purify



Multi level grouping

MODEL NAME	PACSSA000
Size (W x H x D, mm)	253.2 x 167.7 x 28.9
Interfaceable Products	MULTI V / ERV / ERV DX / Hydro kit / THERMA V / AHU Kit / LG Chiller ¹⁾ / Commercial Air Purifier
Maximum number of units	128
Individual / Group Control	On & Off / Mode / Temperature / Fan speed
Individual Controller Lock	Temperature / Mode / Fan speed / All
Advanced Function Setting and Display ²⁾	Comfort Cooling / ODU Low Noise / ODU Defrost Mode / Comfort Level display / CO2 Level display (for ERV / ERV DX) / Night Time Free Cooling (for ERV / ERV DX)
Error Check	○
Slave Mode (Interlocking with higher level controller)	○
Schedule	Weekly / Monthly / Yearly / Exception day
Web Access	○
Emergency Stop & Alarm Display	○
Power Consumption Monitoring (with PDI)	○
Auto Changeover / Setback	○
Temperature Limit	○
Operation Time Limit	○
Visual Navigation	○
Operation Trend	○
Air Purify Control	○
Air Quality Level	○
Interlock Control	○
Virtual Group Control	○
ODU Capacity Control	○
Energy Navigation (with PDI)	○
Daylight Saving Time	○
External IO Port	DI 2 / DO 2
BMS Integration ³⁾	BACnet IP / Modbus TCP
IPv6 Support	○

※ ○ : Applied, - : Not Applied
1) Chiller Option Kit (PCHLLN000) is required.
2) It is only available in some products.
3) For the detail point list, please refer to the installation manual.

AC Smart 5

Air Purify Total Solution

Air Purify Control

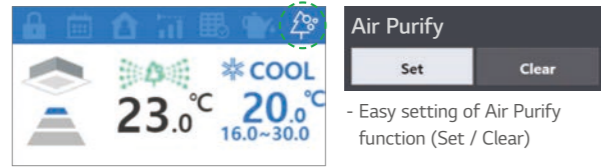

Air Quality Level Monitoring



System Air Conditioner

Commercial Air Purifier

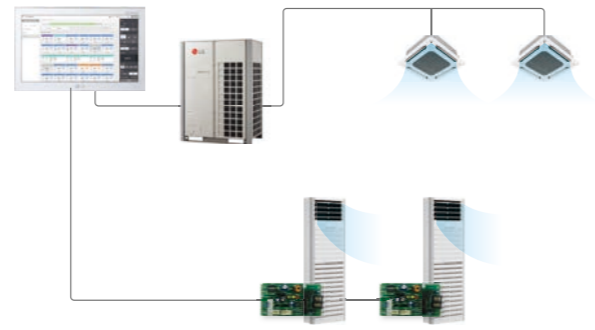

* The Commercial Air purifier must additionally install PI485(PHNFP14A0).

Advanced Network Accessibility

AC Smart 5 reflects the state of the art of network technology trend. IPv6 (Internet Protocol version 6), which is the most recent version of the Internet Protocol provides accessibility to the IPv6 compatible network environment. In addition, HTML5 allows you to easily control LG HVAC system on a variety of platforms (PC, Mobile, Tablet), at any time and from any location, not just on the touch screen.

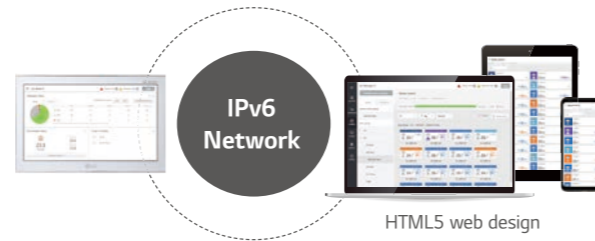

Visualized Control

Visual navigation enables controlling and monitoring the unit on floor, plan view for the intuitive management.



Multi Level Group Composition

User can make frequent and multi level group to control and monitor the device easily.

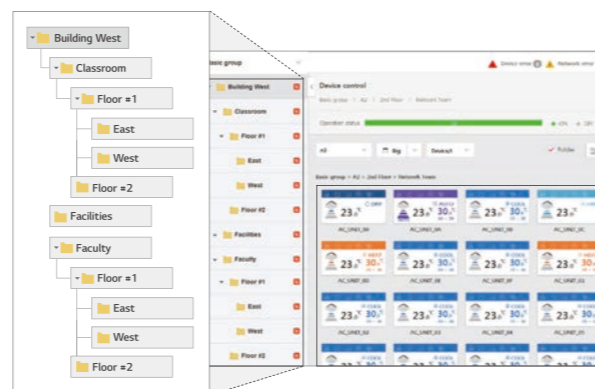

Energy Management

The energy navigation function allows the air conditioner's operational energy usage to be managed monthly, weekly and yearly. By analyzing present energy consumption and comparing with the plan, overuse of system operational costs can be prevented.

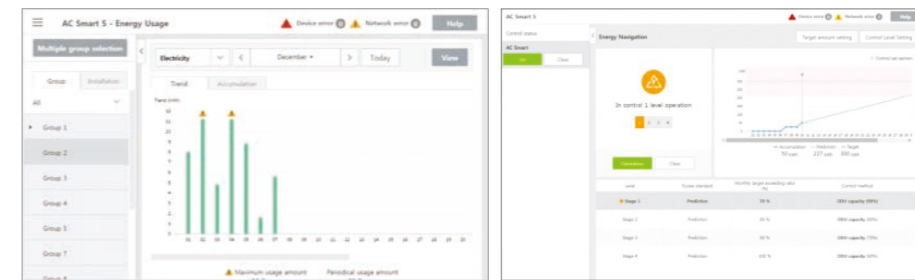

Building Management System (BMS) Integration

Without additional device, AC Smart 5 provides BACnet IP & Modbus TCP interface for BMS integration as well as its own management function.

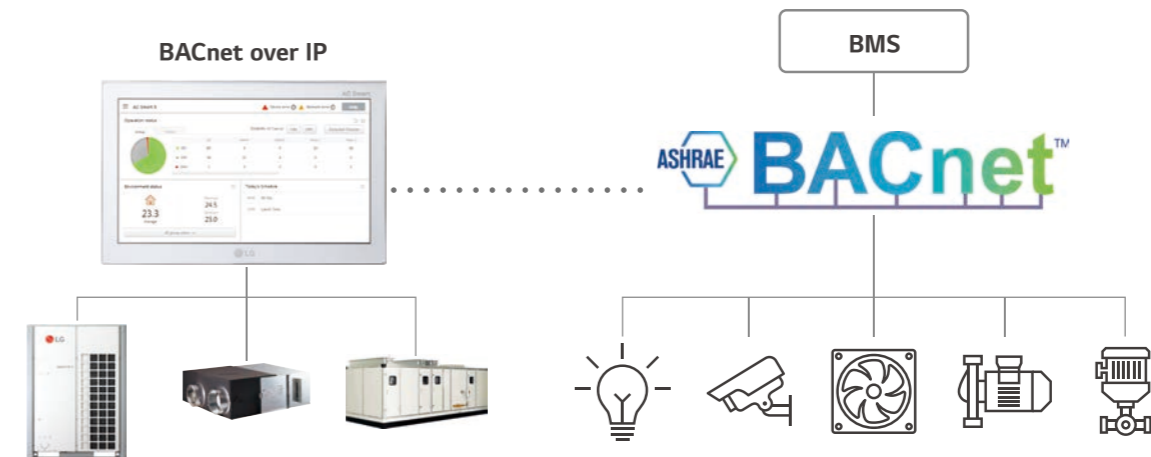

Interlocking with 3rd Party Equipment

AC Smart 5 can make operation scenario with 3rd party equipment by ACS IO Module. Control coverage is expanded. (Air conditioner only → Sensors, Fans, Pumps, Switches...)

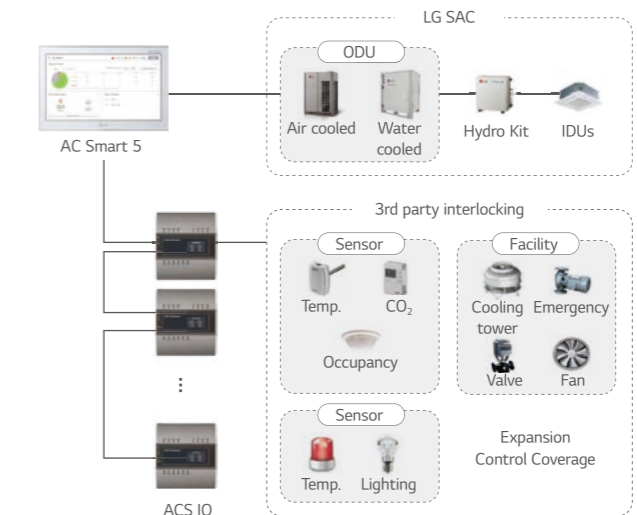

ACP 5

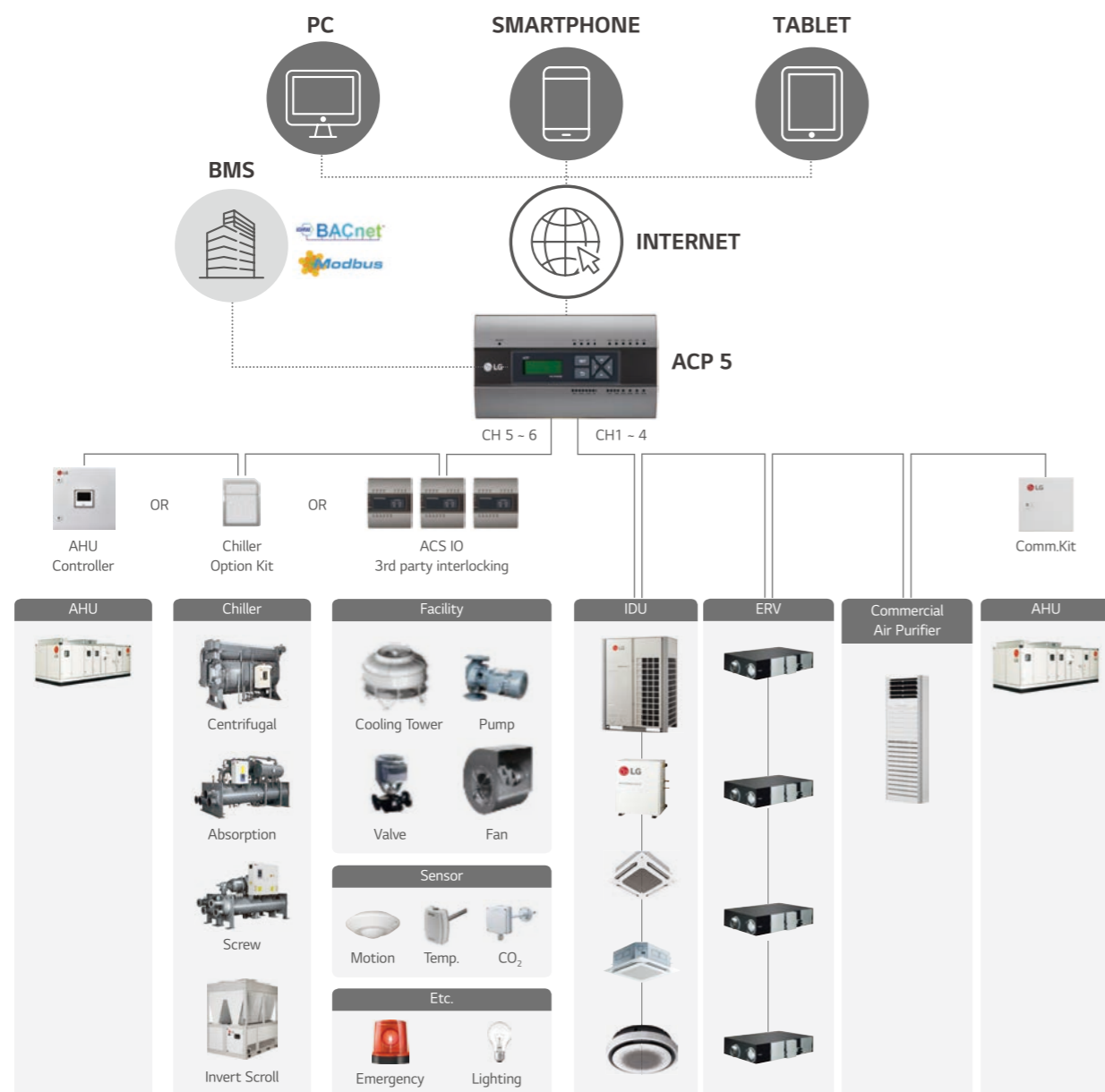

PACP5A000

Advanced solution for BMS integration up to 256 units via BACnet and Modbus protocol as well as its own smart management function with web server interface.



MODEL NAME	PACP5A000
Size (W x H x D, mm)	270 x 155 x 65
Interfaceable Products	MULTI V / ERV / ERV DX / Hydro kit / THERMA V / AHU Kit / LG Chiller ¹⁾ / Commercial Air Purifier
Maximum number of units	256
Individual / Group Control	On & Off / Mode / Temperature / Fan speed
Individual Controller Lock	Temperature / Mode / Fan speed / All
Advanced Function Setting and Display ²⁾	Comfort Cooling / ODU Low Noise / ODU Defrost Mode / Comfort Level display / CO ₂ Level display (for ERV / ERV DX) / Night Time Free Cooling (for ERV / ERV DX)
Error Check	○
Schedule	Weekly / Monthly / Yearly / Exception day
Web Access	○
Emergency Stop & Alarm Display	○
Power Consumption Monitoring (with PDI)	○
Auto Changeover / Setback	○
Temperature Limit	○
Operation Time Limit	○
Visual Navigation	○
Operation Trend	○
Air Purify Control	○
Air Quality Level	○
Interlock Control	○
Virtual Group Control	○
ODU Capacity Control	○
Energy Navigation (with PDI)	○
Daylight Saving Time	○
External IO Port	DI 10 / DO 4
BMS Integration ³⁾	BACnet IP / Modbus TCP
IPv6 Support	○

※ ○ : Applied, - : Not Applied
 1) Chiller Option Kit (PCHLLN000) is required.
 2) It is only available in some products.
 3) For the detail point list, please refer to the installation manual.

Advanced Network Accessibility



* Fix Public IP is mandatory.
 * Router's Configuration of NAT is mandatory. Open port 80 & 9300.

Energy Navigation

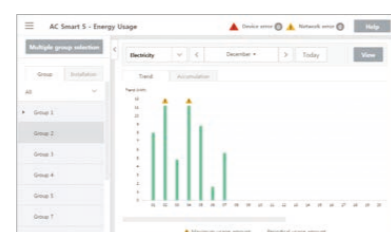

BACnet IP & Modbus TCP

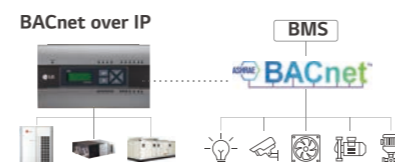

Air Purify Control / Monitoring

Integrated Management

The Commercial Air Purifier can be used with LG central controller to monitor and control.

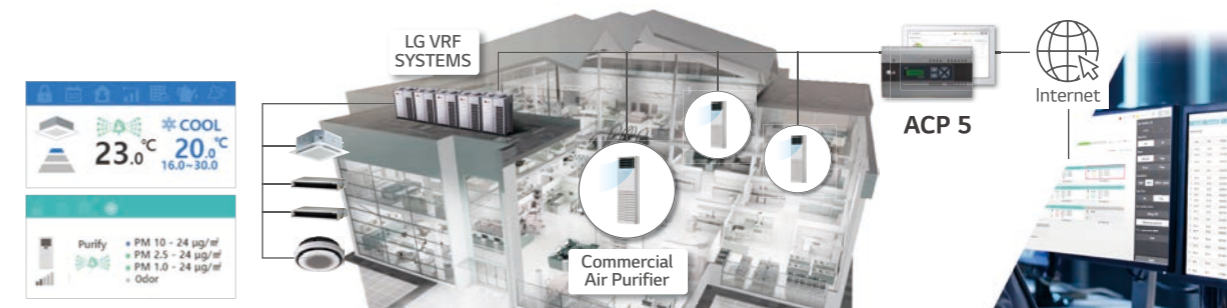

AC MANAGER 5

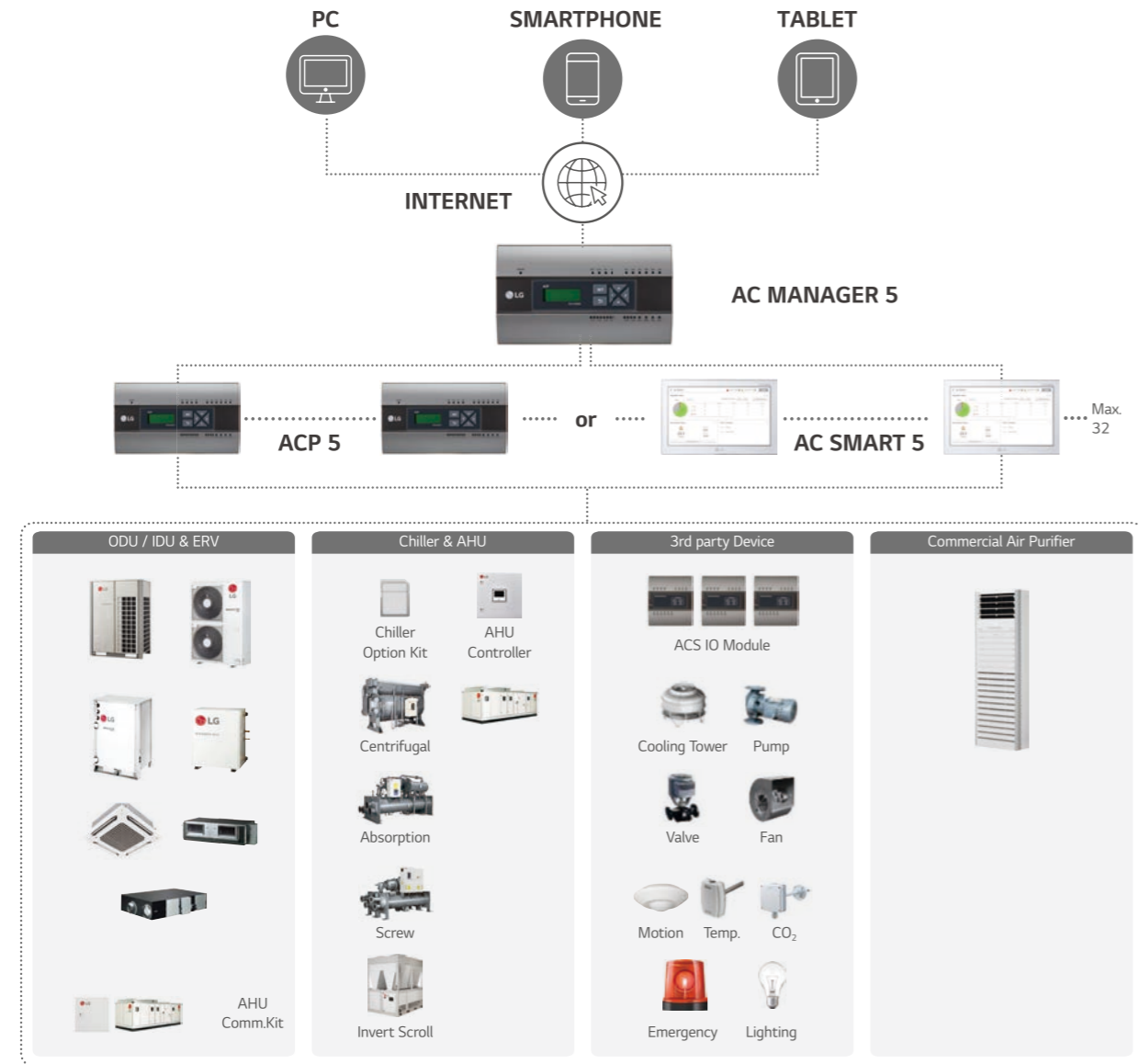

PACM5A000

Multiple ACP and AC Smart integration solution to manage multi sites up to 8,192 units as a single system.



MODEL NAME	PACM5A000
Size (W x H x D, mm)	270 x 155 x 65
Interfaceable Products	MULTI V / ERV / ERV DX / Hydro kit / THERMA V / AHU Kit / LG Chiller ¹⁾ / Commercial Air Purifier
Maximum number of units	8,192 (Supports 32 ACP 5 or AC Smart 5)
Individual / Group Control	On & Off / Mode / Temperature / Fan speed
Individual Controller Lock	Temperature / Mode / Fan speed / All
Error Check	○
Schedule	Weekly / Monthly / Yearly / Exception day
Web Access	○
Emergency Alarm Display	○
Power Consumption Monitoring (with PDI)	○
Auto Changeover / Setback	○
Temperature Limit	○
Operation Time Limit	○
Visual Navigation	○
Operation Trend	○
Air Purify Control	○
Air Quality Level	○
Interlock Control	○
Virtual Group Control	○
ODU Capacity Control	○
Energy Navigation (with PDI)	○

※ ○ : Applied, - : Not Applied
 1) Chiller Option Kit (PCHLLN000) is required for ACP 5 or AC Smart 5.
 Note : AC Manager 5 required for ACP 5 or AC Smart 5

Up to 8,192 Connections for Indoor Units

Administrators can easily and conveniently manage a variety of LG HVAC equipment. Also, it is available to manage many buildings or areas at one place via AC Manager 5.

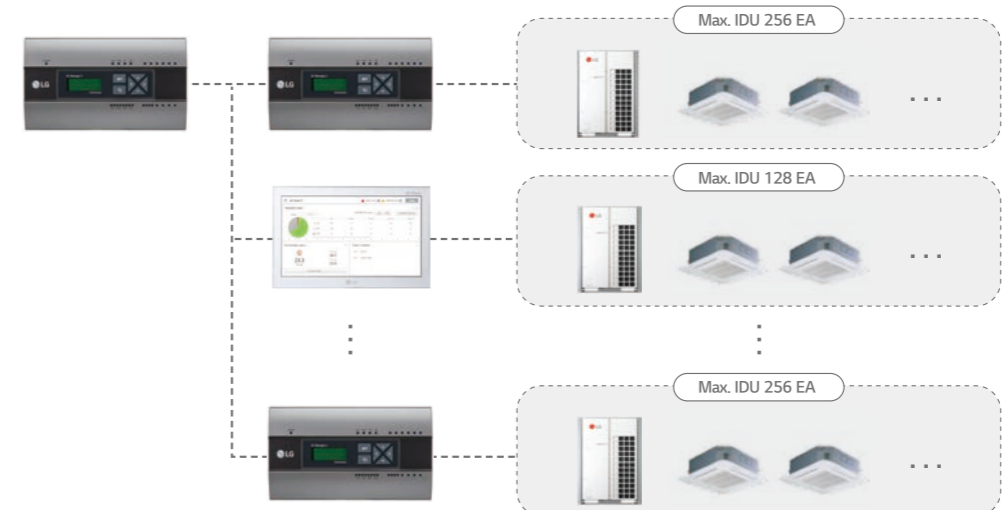

AC MANAGER 5

Smart Air Purify Solution

Total management of air purify function creates clean environment everyday.

Air Quality Multi Status view

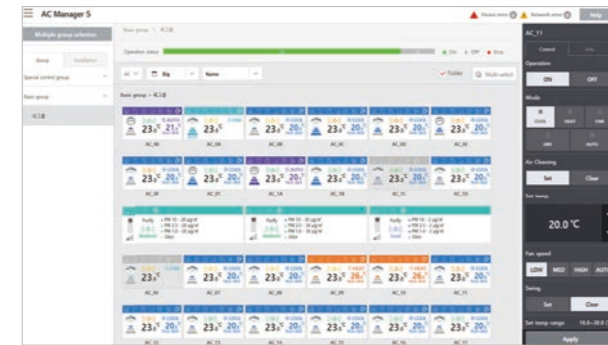

Air Quality Summary Widget

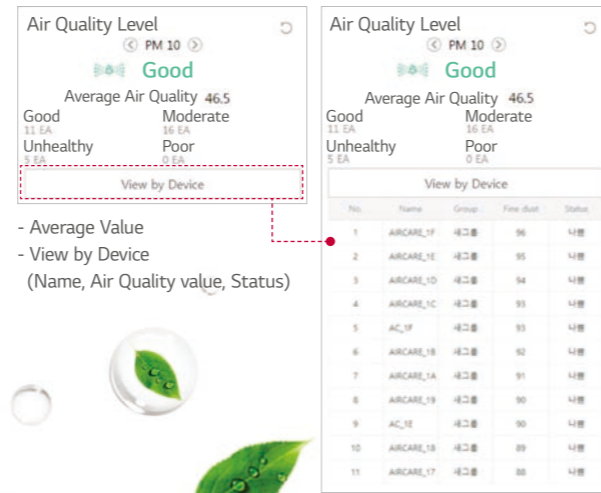

- Average Value
- View by Device (Name, Air Quality value, Status)

Air Purify Control

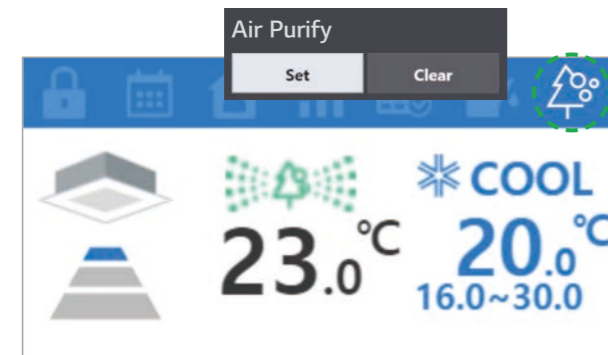

- Easy setting of Air Purify function (Set / Clear)

View Air Quality Trends

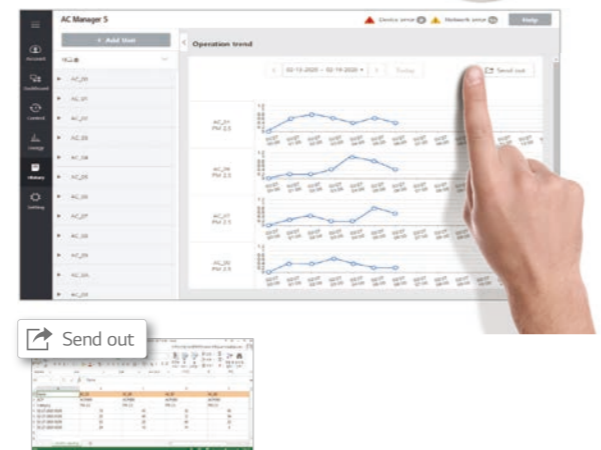

- Daily (per hour), period (30 days) shows trends
- Excel output / easy to manage

Advanced Network Accessibility & User Friendly GUI

As an advanced central controller, AC Manager 5 offers flexible interface for each user by assessing the device screen and automatically customizing the layout to provide the most optimized interface.



Energy Navigation & Energy Usage Graph

Energy navigation is the function to set the target usage amount to limit the monthly power consumption and to control so that the total accumulated power consumption does not exceed the target usage amount. It performs total of 7 control levels with the estimated / actual usage amount exceeding ratio compared to the monthly target usage amount. For the control method, there are indoor unit operation ratio, outdoor unit capacity control, and indoor unit operation control.



Peak Control

This function can reduce electricity use. There are two kinds of control logic. Energy saving effect by indoor unit operation rate control. Load management effect by outdoor unit capacity control.

Operation ratio (IDUs) Control



ODU Capacity Control

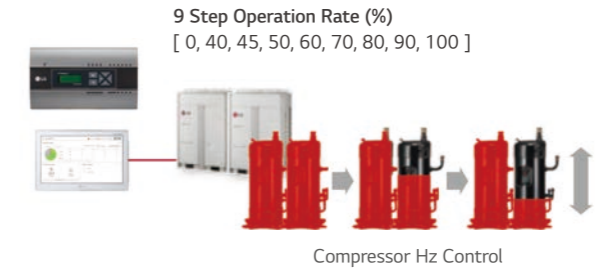

Multi Level Group Composition

User can make frequent and multi level group to control and monitor the device easily.



ACP LonWorks Gateway

PLNWK000

LonWorks easily link LG Air conditioners and other existing building systems.
By including ACP control function, the controlling continues even when error occurs with BMS.



Features & Benefits

- Connect to use LonWorks protocol and LG Air conditioner protocol.
- Process ability (Max. connection) : Indoor unit 64EA, AHU Control Kit : Max. 16EA
- Self installation verification using internet (Web Server Included)
- Diagnosis of communication status on LG Air conditioner network
- It offers a variety of functions as ACP which allows the customer to efficiently control various types of equipment from the customer's own integration.

CONTROL	MONITORING
On / Off Command	On / Off
Operation Mode Setting	Operation Mode
Lock	Lock
Temperature	Temperature
Fan Level	Fan Level
Fan Direction Auto	Fan Direction Auto
Mode Lock	Mode Lock
Fan Level Lock	Fan Level Lock
Temperature Lock	Temperature Lock
Temperature Lower Limit	Temperature Lower Limit
Temperature Higher Limit	Temperature Higher Limit
Peak Convert Cycle	Peak Convert Cycle
Peak Setting	Peak Setting
Temperature Unit	Temperature Unit
Total Temperature Lock	-
Total On / Off	-
Total Temperature	-
-	Product Type
-	Product Address
-	Current Temperature
-	Alarm
-	Power
-	Error Code
-	Peak Current Operating Percent
-	Total Accumulate Power

※ ○ : Applied, - : Not Applied

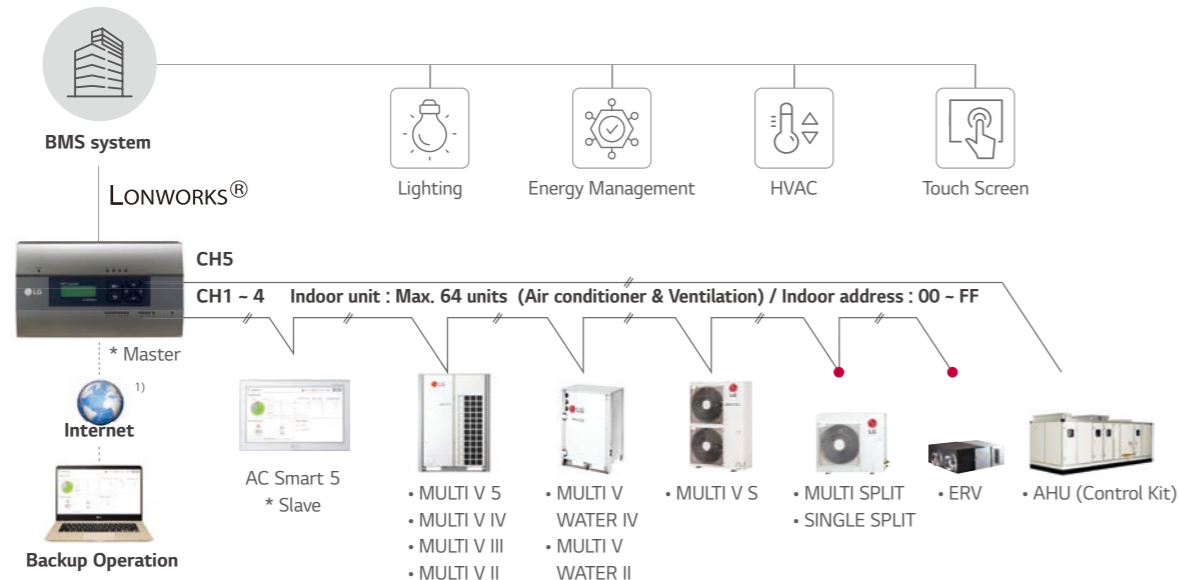

1) Assignment of public IP address is required to access central controller through internet. ● Appropriate PI485 should be used according to PDB (Product Data Book).

PI485

PI485 converts LG Air conditioners protocol to the RS485 protocol for the central controller.

PMNFP14A1

Easy to manage up to 64 indoor units, including ERV with simple interface.

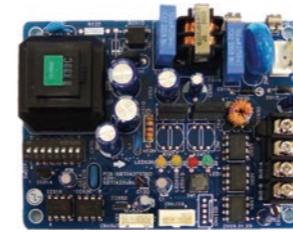

- Power : Single phase AC 220V 50 / 60Hz
- **1 for Each Outdoor Unit**
- Multi V MINI (ARUN40GS2A / ARUV40GS2A Only needs PI485)
- Single Split
- Multi Split
- Therma V

PHNFP14A0



- Power : Connected with the Indoor Units
- **1 for Each Indoor Unit**
- Indoor Unit (ERV)

MODBUS RTU Gateway

PMBUS00A

Providing Modbus RTU connection between LG Air conditioners and BMS.



Features & Benefits

- Function
- Modbus RTU communication with Modbus master controller
- Modbus RTU slave (RS485) / 9,600 bps
- Applicable for MULTI V 5, ERV, Heating
- Size (W x H x D, mm) : 53.6 x 89.7 x 60.7
- Max. 16 IDUs with single module / Max. 64 IDUs with 4 modules
- Power : DC 12V
- No slave allowed in LGAP

Installation Scene

Single Module

Max. 16 indoor units with a single module

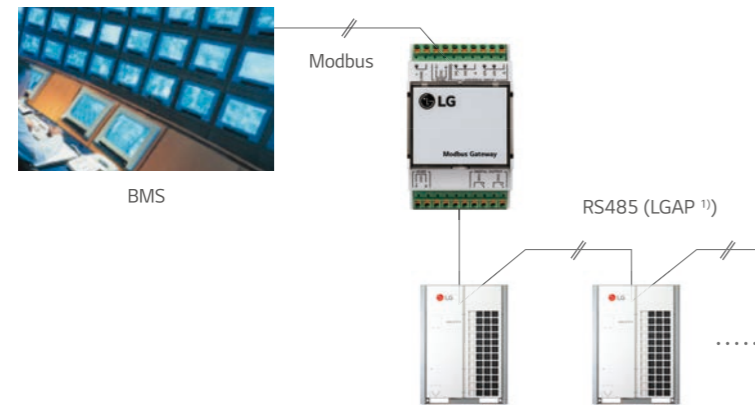

Multiple Module

Max. 64 indoor units with 4 modules in one Modbus communication line

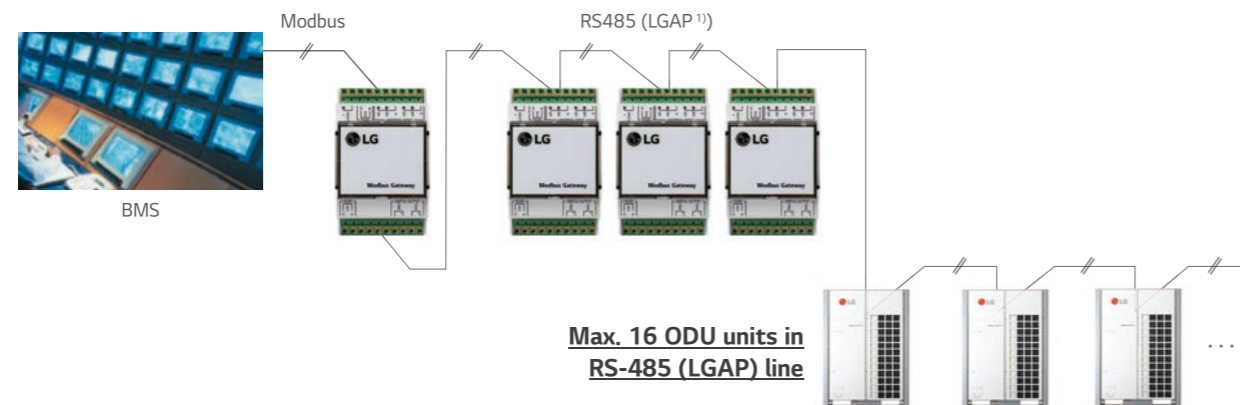

1) LGAP is LG Protocol
Max. 16 ODU units in RS-485

Modbus Gateway Memory Map

Baud Rate : 9,600 bps, Stop Bit : 1 stop bit, Parity : None Parity, Byte size : 8 bits

Coil Register (0 x 01)

NO.	DATA BIT			FUNCTION	REGISTER
	AIR CONDITIONER	ERV / DX ERV	HYDR0 KIT & THERMA V		
1	Operate (On / Off)	Operate (On / Off)	Operate (On / Off)	0 : Stop / 1 : Run	Register = N X 16 + ① (N = Indoor Unit Central Address)
2	Auto Swing	Aircon Operate (On / Off)	Hot Water Mode (On / Off)	0 : Disable / 1 : Enable	
3	Filter Alarm Release	Filter Alarm Release ¹⁾	Reserved	0 : Normal / 1 : Alarm Release	
4	Lock Remote Controller	Lock Remote Controller	Lock Remote Controller	0 : UnLock / 1 : Lock	
5	Lock Operate Mode	Lock Operate Mode ¹⁾	Reserved	0 : UnLock / 1 : Lock	
6	Lock Fan Speed	Lock Fan Speed ¹⁾	Reserved	0 : UnLock / 1 : Lock	
7	Lock Target Temp.	Lock Target Temp. ¹⁾	Reserved	0 : UnLock / 1 : Lock	
8	Lock IDU Address	Lock IDU Address ¹⁾	Reserved	0 : UnLock / 1 : Lock	
9	Reserved	Quick Ventilate	Reserved	0 : Disable / 1 : Enable	
10	Reserved	Energy Save	Reserved	0 : Disable / 1 : Enable	

1) : This register value is applied 'DX Ventilator' ONLY.

Discrete Register (0 x 02)

NO.	DATA BIT			FUNCTION	REGISTER
	AIR CONDITIONER	ERV / DX ERV	HYDR0 KIT & THERMA V		
1	Connected IDU	Connected IDU	Connected IDU	0 : Disconnected / 1 : Connected	Register = N X 16 + ① (N = Indoor Unit Central Address)
2	Alarm	Alarm	Alarm	0 : Normal / 1 : Alarm	
3	Filter Alarm	Filter Alarm ¹⁾	Hot Water Only ²⁾	• 0 : Normal / 1 : Alarm Hydro Kit • 0 : Normal / 1 : Hot Water Only	
4	Reserved	Reserved	Target Temp. Select	0 : Air / 1 : Water	
5	Reserved	Reserved	Error Division ²⁾	0 : CH type error / 1 : BC type error	

1) : This register value is applied 'DX Ventilator' ONLY.

2) : This register value is applied 'Hydro Kit' ONLY.

Holding Register (0 x 03)

NO.	DATA BIT			FUNCTION	REGISTER
	AIR CONDITIONER	ERV / DX ERV	HYDR0 KIT & THERMA V		
1	Operate Mode	Operate Mode	Operate Mode	• 0 : Cooling, 1 : Dehumidifying, 2 : Fan, 3 : Auto, 4 : Heating Hydro Kit (Middle Temp. DHW) / AWHP • 0 : Cooling, 3 : Auto, 4 : Heating Hydro Kit (High Temp. DHW)	Register = N X 20 + ① (N = Indoor Unit Central Address)
2	Fan Speed	Fan Speed	Target Temp. DHW ²⁾	1 : Low, 2 : Mid, 3 : High, 4 : Auto	
3	Target Temp.	Target Temp. ¹⁾	Target Temp. ²⁾	16.0 ~ 30.0 [°C] x 10	
4	Target Temp. Limit (Upper)	Target Temp. Limit ¹⁾ (Upper)	Reserved	16.0 ~ 30.0 [°C] x 10	
5	Target Temp. Limit (Lower)	Target Temp. Limit ¹⁾ (Lower)	Reserved	16.0 ~ 30.0 [°C] x 10	
6	Reserved	Vent. Operate Mode	Reserved	0 : HEX, 1 : Auto, 2 : Normal	

1) : This register value is applied 'DX Ventilator' ONLY.

2) : This value range can be between 0 ~ 127 [°C]. And it would be limited by upper & lower value according to the setting of remote controller.

Input Register (0 x 04)

NO.	DATA BIT			FUNCTION	REGISTER
	AIR CONDITIONER	ERV / DX ERV	HYDR0 KIT & THERMA V		
1	Error Code	Error Code	Error Code	0 ~ 255 ※ Please refer to the product error table.	Register = N X 20 + ① (N = Indoor Unit Central Address)
2	Room Temp.	RA Temp.	Room Temp.	-99.0 ~ 99.0 [°C] x 10	
3	Pipe In Temp.	OA Temp. ¹⁾	Water Inlet Temp.	-99.0 ~ 99.0 [°C] x 10	
4	Pipe Out Temp.	SA Temp. ¹⁾	Water Outlet Temp.	-99.0 ~ 99.0 [°C] x 10	
5	Reserved	Pipe In Temp. ¹⁾	Sanitary Tank Temp.	-99.0 ~ 99.0 [°C] x 10	
6	Reserved	Pipe Out Temp. ¹⁾	Solar Temp. ²⁾	-99.0 ~ 99.0 [°C] x 10	

1) : This register value is applied 'DX Ventilator' ONLY.

2) : This register value is applied AWHP' ONLY.



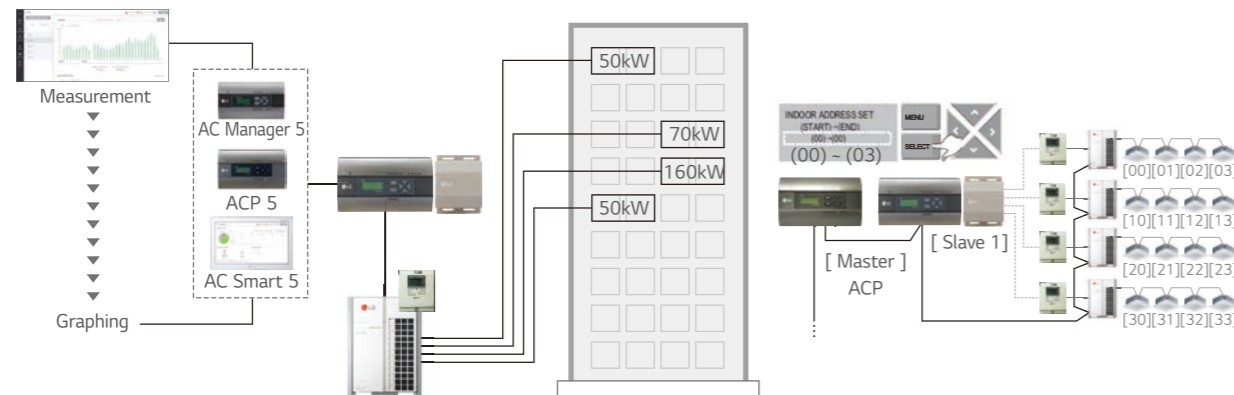
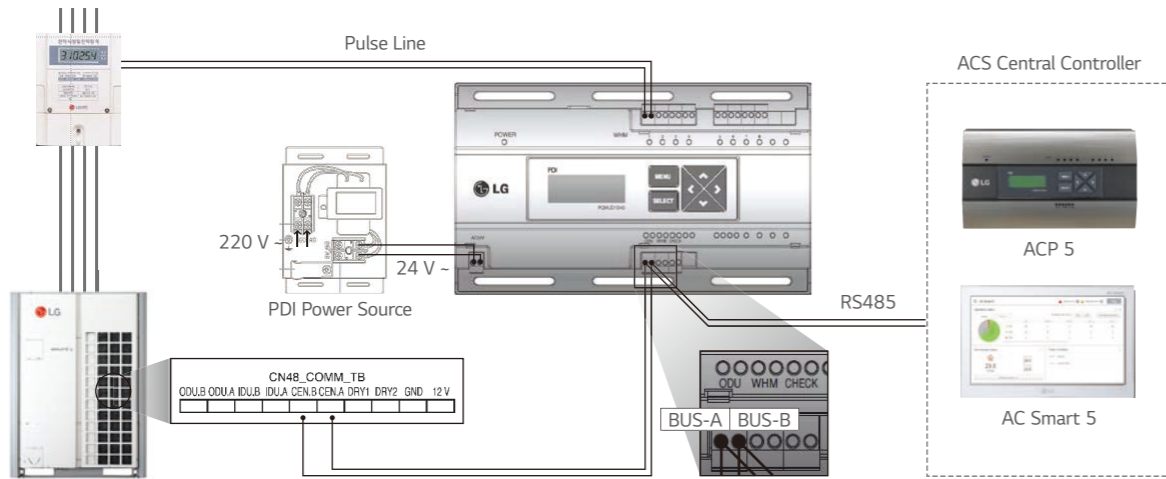

Note:
 1. Power cable and type could be different from this scene depending on the Outdoor unit's specification.
 2. Measured power consumption could be different between PDI and Watt meter.
 3. Applicable Central Controller: ACP 5, ACP LonWorks, AC Smart 5, AC Ez Touch
 (Combination: we recommend to connect separated watt meter for Outdoor units to have correct power distribution value)

PDI (Power Distribution Indicator)

PQNUD1S40 (Premium, 8 ports) / PPWRDB000 (Standard, 2 ports)

PDI shows distributed power consumption of up to 128 indoor units.

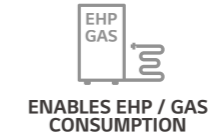
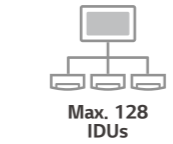

Features & Benefits

- Enables total and indoor power consumption monitoring.
- With LG central control connectivity, energy monitoring, energy savings operations and target usage setting functions are enabled.
- Enables gas consumption and electricity distribution.

MODEL NAME	PQNUD1S40	PPWRDB000
Size (W x H x D, mm)	270 x 155 x 65	
Interfaceable Products	Air conditioner, ERV DX	
Maximum Number of Power Meters	EHP : 8 Watt meter GHP : 4 Watt meter / 4 Gas meter	EHP : 2 Watt meter GHP : 1 Watt meter / 1 Gas meter
Maximum Number of Indoor Units	Multi V : 128	
Data Backup When Power Outage	○	
Power Input	PDI : AC 24V, Transformer : AC 220V	

※ ○ : Applied, - : Not Applied

ACS IO Module

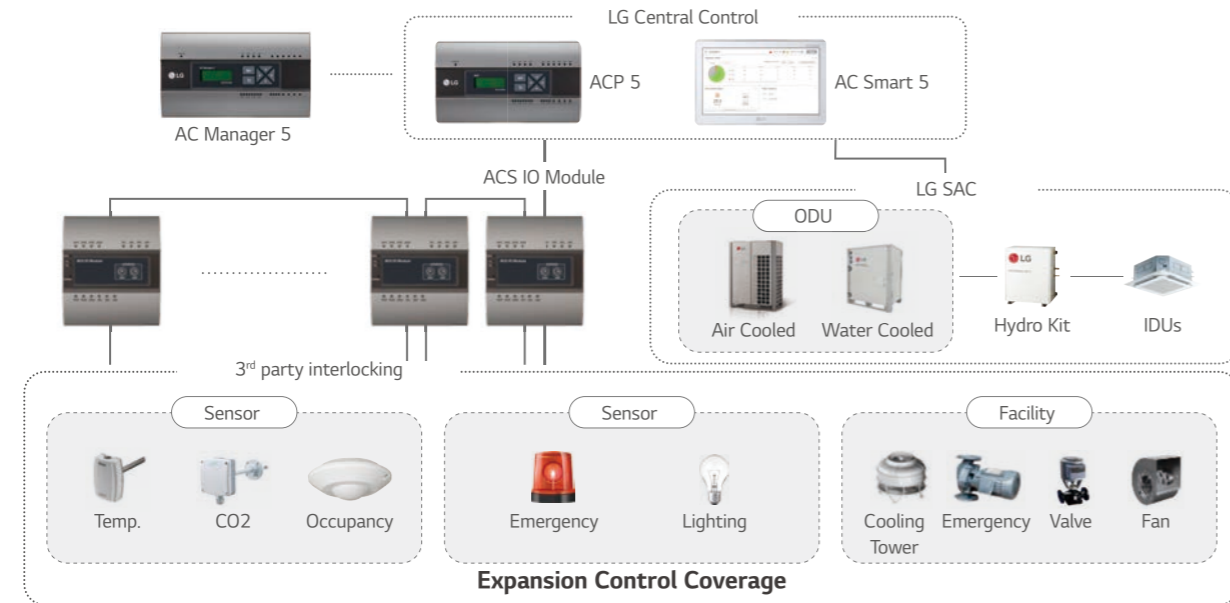

※ DI : Digital Input, DO : Digital Output, UI : Universal Input, AO : Analog Output

Case. 1

Parking Lot Ventilation

Turning on ventilator when CO₂ Level is high

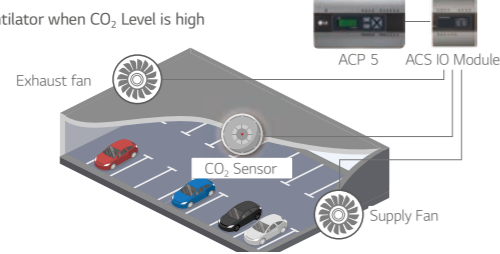

Case. 1

Auxiliary Heater

Turning on aux. heater when outside temp. is very low

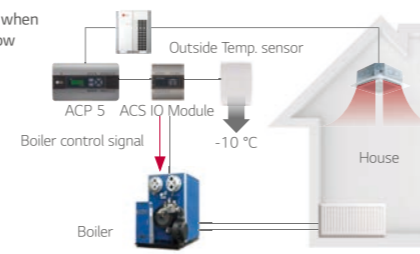

PEXPMB000

This module can be connected with ACP 5 or AC Smart 5 controller if additional I / O points such as DI / DO and AI / AO for 3rd party devices control and monitoring are needed.



Features & Benefits

- Interlocking with 3rd party equipment, LG Central controller can make operation scenario with 3rd party equipment by ACS IO Module.
- Control coverage is expanded. (Air conditioner only → Sensors, Fans, Pumps, Switches ...)

MODEL NAME		PEXPMB000	
Linkable Products		PAC55A000, PACP5A000	
Communication		RS-485	
		1 ch	
I / O	Digital Input	3 ports	
	Digital Output	3 ports	
	Universal Input ¹⁾	4 ports	
	Analog Output	4 ports	
VALUE SPEC		MIN.	MAX.
Analog Input	NTC 10k	0.68kΩ	177kΩ
	PT 1000	803Ω	1,573Ω
	Ni 1000	871.7Ω	1,675.2Ω
	DC (Voltage)	0V	10V
Analog Output		0V	10V
Digital Input	Binary Input (Non Voltage)	-	-
Digital Output	Normal open	-	30VAC / 30VDC, 2A

※ ○ : Applied, - : Not Applied
 1) The type of UI (Universal Input) is selectable among Digital Input and Analog Input.
 Note: ACS IO & ACU IO are not a replacement for Direct Digital Controller(DDC) or PLC.

ACU IO Module

PEXPMB300, PEXPMB200, PEXPMB100

This module can be connected with ACP 5 or AC Smart 5 controller if additional I / O points such as UIO / UI / UO for 3rd party devices control and monitoring are needed.

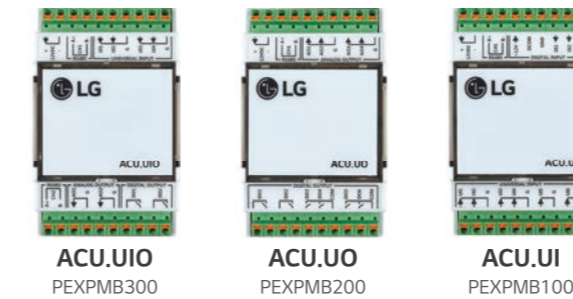

Features & Benefits

- Interlocking with 3rd party equipment LG Central controller can make operation scenario with 3rd party equipment by ACU IO Module.
- Applicable devices are expanded. (Air conditioner only → Sensors, Fans, Pumps, Switches ...)

MODULE NAME	PEXPMB300	PEXPMB200	PEXPMB100
Linkable Products	PAC55A000, PACP5A000		
Communication RS-485	1 ch	1 ch	1 ch
Digital Input	-	-	3 ports
Digital Output	2 ports	6 ports	-
Universal Input ¹⁾	4 ports	-	6 ports
Analog Output	2 ports	4 ports	-

VALUE SPEC		MIN.	MAX.
Analog Input	DC (Voltage)	0V	10V
Analog Output	DC (Voltage)	0V	10V
Digital Input	Binary Input (Non Voltage)	-	-
Digital Output	Normal Open	-	30VDC, 1A

※ ○ : Applied, - : Not Applied
 1) The type of UI (Universal Input) is selectable among Digital Input and Analog Input.

Chiller Option Kit

PCHLLN000

LG central controller 5 series with Chiller Option Kit can provide LG chiller remote control and cycle monitoring.



MODEL NAME	PCHLLN000
Monitoring Points	Evaporator status / Compressor status (Scroll, Screw, Centrifugal chiller only) / Condenser status / Generator status (Abs. chiller only)
On / Off	○
Target Temp. setting	○
Mode	Scroll chiller only
Schedule	○
Interfaceable Products	Scroll, Screw, Centrifugal, Absorption (LG Only)

※ ○ : Applied, - : Not Applied

Installation Scene

- Chiller Option Kit installation of ACP, AC Smart should be conducted by a specialized installation service engineer.
- Chiller Option Kit installation can be achieved with a SD Card.
- The SD Card can install Chiller Option Kit in one ACP, AC Smart. Insert the SD Card in the ACP, AC Smart. If a backup SD Card is inserted, replace it with a Chiller Option Kit SD Card.



Cycle Display Example

Turbo Chiller Cycle information
 View all Evaporator Compressor Condenser

Mode	COOL	Evaporator water out temperature	30.3 °C
Operation	ON	Motor current	6 A
Evaporator			
Flow amount	ON	Saturation temperature	23.2 °C
Water in temperature	20 °C	Pressure	2.01 kgf / cm ²
Water out temperature	30.3 °C		

DRY CONTACT

PDRYCB000

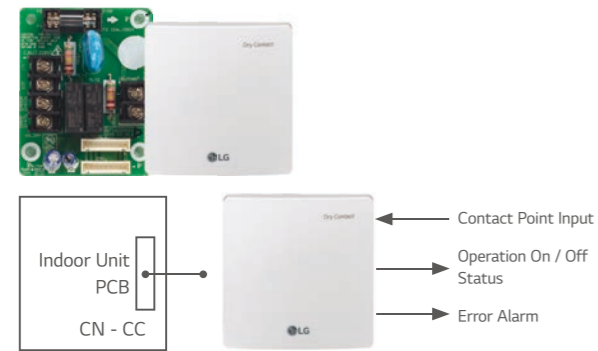

Simple Dry Contact (1 input)



PDRYCB400

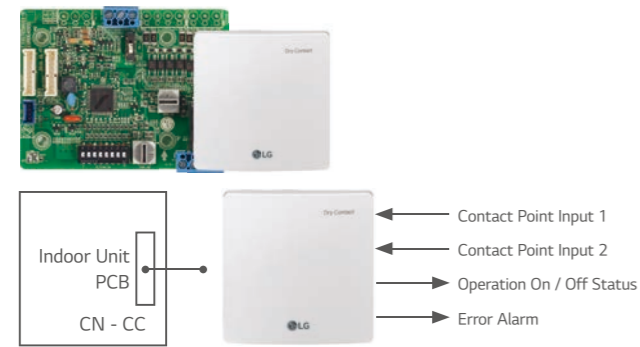

Dry Contact for 2 Input

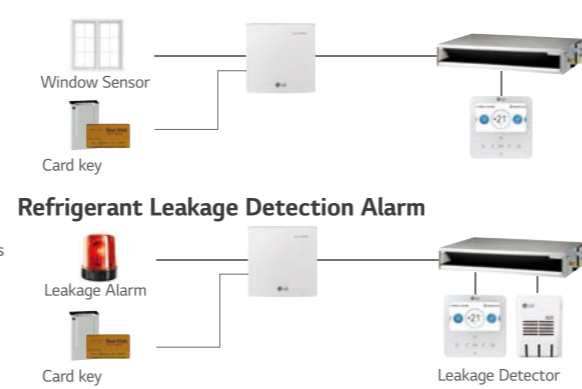

PDRYCB320

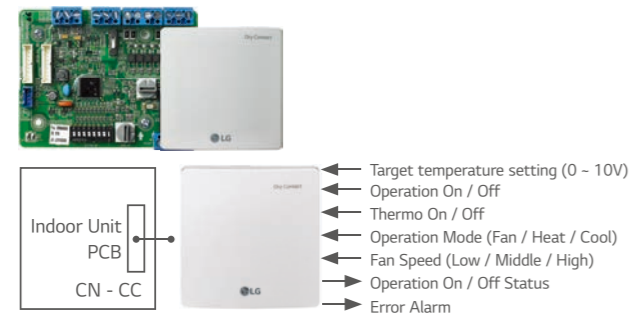

Dry Contact for Thermostat



※ Please contact our regional office to have full compatible room controller list.

PDRYCB500

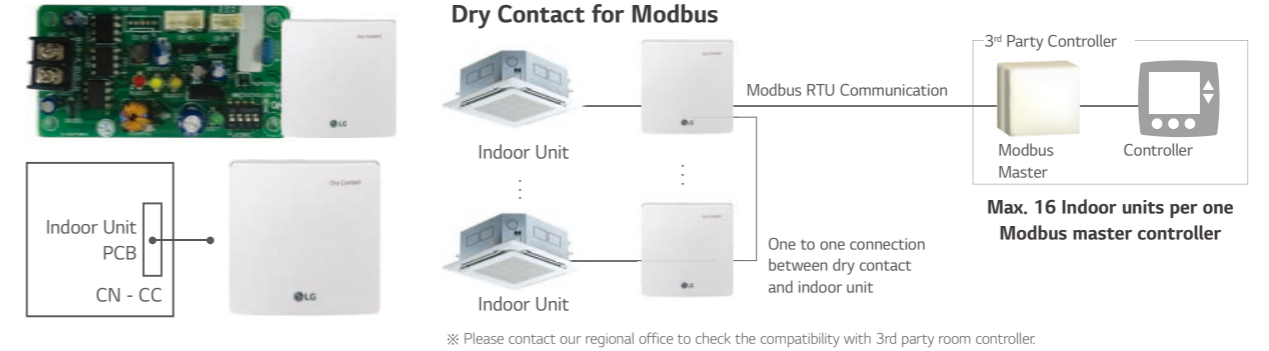

※ Please contact our regional office to check the compatibility with 3rd party room controller.

Specification

Connection between an indoor unit and external devices to control various functions.

MODEL NAME		PDRYCB000	PDRYCB400	PDRYCB320	PDRYCB500
Case		○	○	○	○
Input Port		1	2	8	-
Universal Input port		-	-	1	-
Comm. Protocol		-	-	-	Modbus RTU
Power		AC 220V	Connect to Indoor unit PCB (CN_CC) : DC 12V		
IDU	On / Off	○	○	○	○
	Operation Mode	-	○	○	○
	Set Temp.	-	(Select & Fix)	(Select & Fix)	○
	Fan Speed	-	-	○	○
	Thermo-Off	-	(Select & Fix)	○	-
	Energy Saving	-	(Select & Fix)	-	-
	Lock / Unlock	-	(Select & Fix)	-	-
	Control	On / Off	○	-	○
Heating	DHW On / Off	-	-	○	-
	Thermo-Off	-	-	○	-
	Operation Mode	-	-	○	-
	Silent Mode	-	-	○	-
	Emergency Mode	-	-	○	-
ERV	On / Off	○	-	-	○
	Operation Mode	-	-	-	○
	Aircon Mode	-	-	-	○
	Additional Mode	-	-	-	○
Output	Fan Speed	-	-	-	○
	Operation Status	○	○	○	○
	Error	○	○	○	○
	Room Temp.	-	-	-	○

※ ○ : Applied, - : Not Applied

Note :

1. Compatibility of PDRYCB320

- Can use with all types of aircon indoor units after 2010. (Cassette, Ducted, Convertible, Applied PAC, Wall mounted, Console)
- Can use with new single package AK-W model after 2020. 1Q (The previous version Single package is not compatible)
- Can not use with AWHP, Hydro Kit models.

- Heating : 3 series AWHP split and Monobloc models 4 generation Hydro Kit

2. Compatibility of PDRYCB400

- Can use with all types of air conditioner indoor units after 2010. (Cassette, Ducted, Convertible, Applied PAC, Wall mounted, Console)
- Can use with new single package AK-W model after 2020. 1Q (The previous version Single package is not compatible)
- Can not use with AWHP, Hydro Kit models.

3. (Select & Fix) : This function is preset by rotary switch.

Group Control Wire

PZCWRCG3

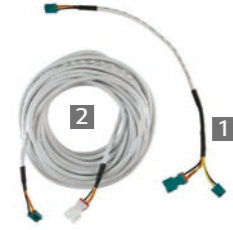

MODEL NAME	PZCWRCG3
1 Y-type Cable	0.25m Length
2 Long Cable	9.6m Length

Installation Scene

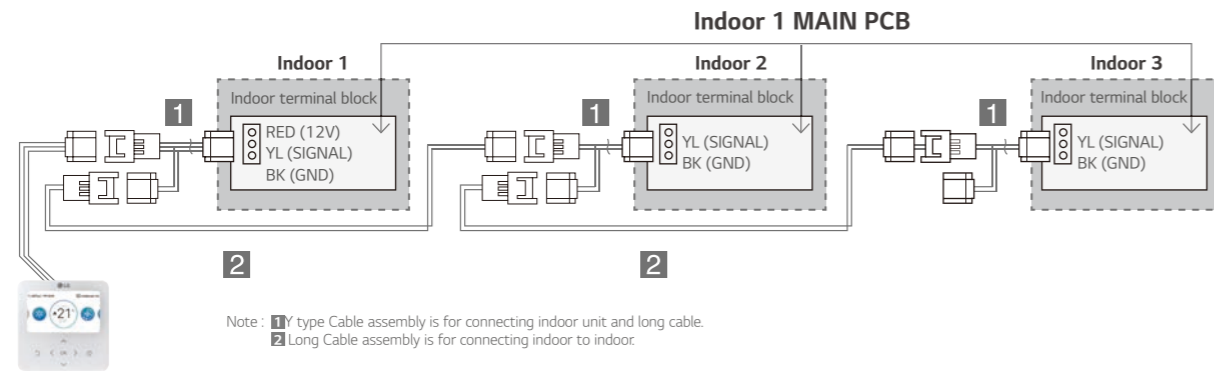

Remote Temperature Sensor

PQRSTAO

Sensor for detecting the room temperature.



Features & Benefits

- It detects the exact room temperature instead of indoor unit's air temperature sensor.
- Applied to Ceiling Mounted Cassette, Ceiling Concealed Duct, THERMA V and Hydro Kit.
- Extension cable (15m) is included.

Installation Scene

1. Wire to the control box in the indoor unit by removing the existing thermistor and connect the extension cable its place.
2. Cut the extension cable to the appropriate length and connect the screw terminal of the remote sensor.

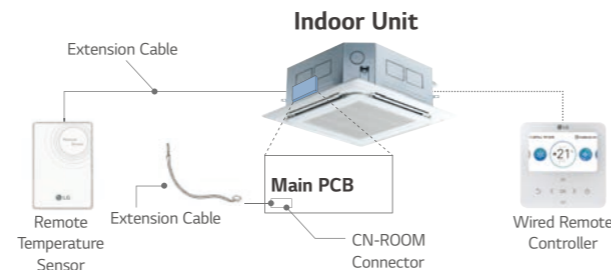

Zone Controller

ABZCA

Controls air conditioning in up to 4 zones by external thermostat.



Features & Benefits

- Controls different zones (up to 4 zones) by external thermostat (AC 24V)
- Maintain proper air volume of each zone
- Auto variation of dampers
- Auto control of fan speed and On / Off operation

Installation Scene

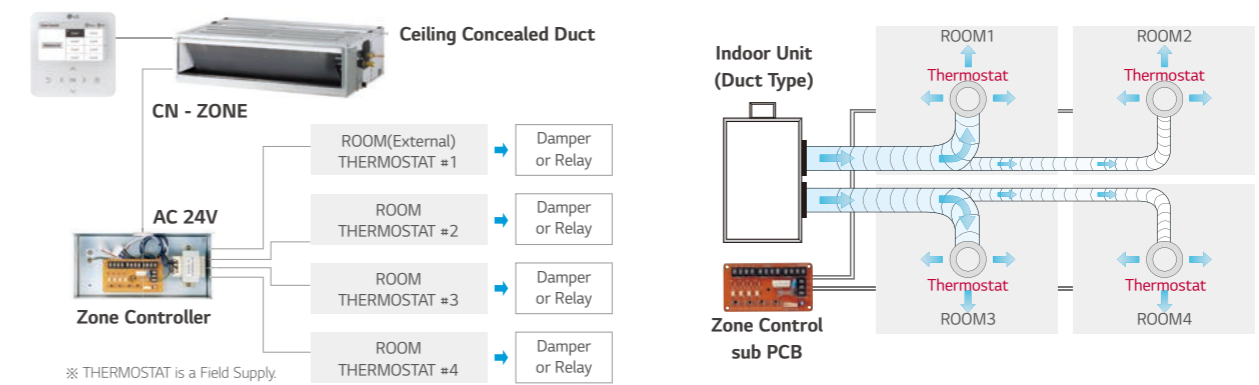

IO Module

PVDSMN000

Interface module between the outdoor unit of system air conditioner and the external device.



Features & Benefits

- Function
- Demand control
 - Low noise operation
 - Output outdoor or indoor unit operation status
 - Output error status

Description

- IO Module is communication interface module for connection between MULTI V 5 and external IO (Input / Output Module) devices.

Models Applied

- MULTI V IV, 5
- MULTI V WATER IV
- MULTI V S

Note : IO Module is not compatible for Multi V III and Multi V S R32.

Part Description

- 1) Digital Input Part (DI : Dry Contact Input)
 - Demand control by contact input (3 Step)
 - Low Noise Operation input
 - Priority Setting input : Setting the priority of demand control command (Capacity control for external signal from DDC vs Peak control by LG Central controller)
 - Open : External signal has priority to central controller (Default)
 - Close : Central controller has priority to external signal
- 2) Analog Input Part (AI : DC 0 ~ 10V)
 - Demand control by analog input (10 Step)
- 3) Digital Output Part (DO : AC 250V, Max. 1A)
 - Error status relay output
 - Operation status relay output
 - Valve control

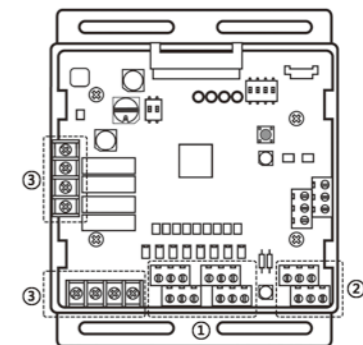

IO Module

ODU Capacity Control

Provides variable settings for ODU Capacity Control according to input method to reduce the power consumption. IO Module supports 2 types of input signal : Analog Inputs (0 - 10V, 10 steps) and contact signals (3 steps)

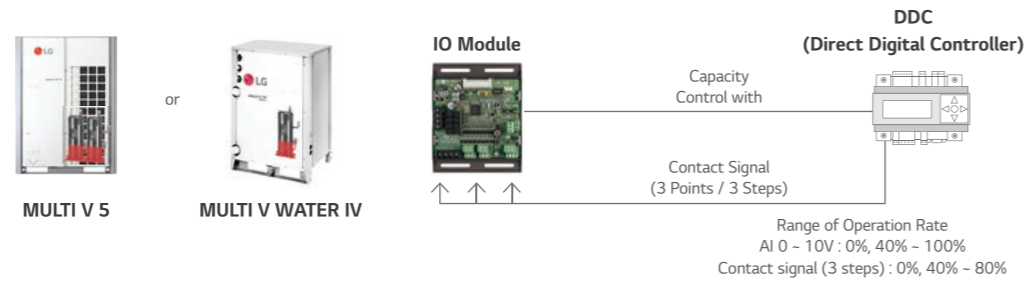

Low Noise Operation

To reduce noise level, control outdoor unit's fan speed by dry contact input.

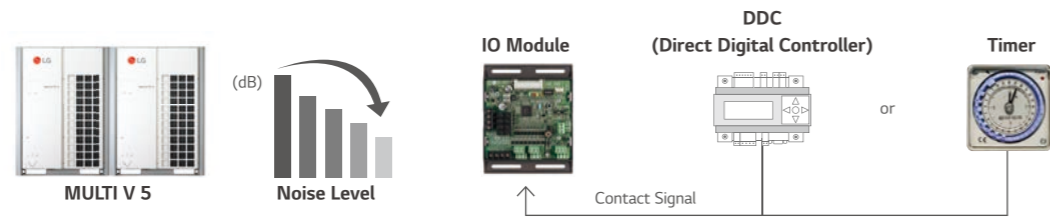

※ 8 HP (22.4kW) model, Sound power level can be changed by outdoor unit operation status and low noise operation input signal.

Refrigerant Leakage Detection with Pump-down

For safety, IO module closes refrigerant valve during Pump-down operation.

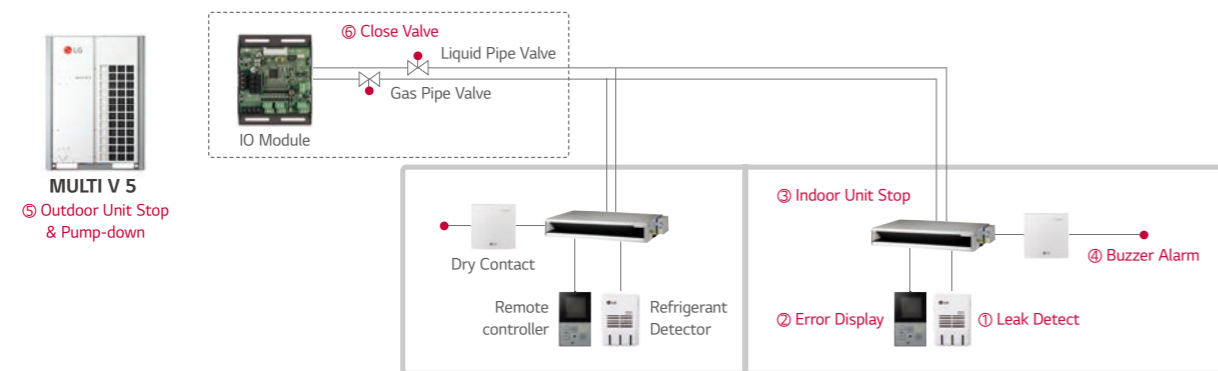

※ If the concentration of the refrigerant in the air exceeds 6,000 ppm more than 5 seconds, the function will be activated. (Refer to operation sequence which written in red, 1-6)

Variable Water Flow Control Kit

PWFCKN000 (MULTI V WATER IV)

Accessory for controlling the water flow.

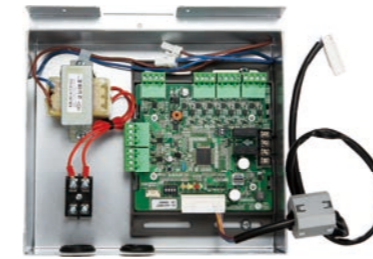

Features

Function

- Water pump or valve control (0 - 10V)
- Minimum output voltage setting available
- Operation, error output (AC 250V, Max. 1A)
- Dry contact input and analog output for demand control
- Digital output for operation, error status (AC 250V, Max. 1A)

Description

- Water flow consumption reduction
- Pump electricity consumption reduction
- Including IO Module (Dry contact input, Analog input / output, Digital output)
- Using Dry contact and variable water flow control function simultaneously.

Installation Scene

- Flow Control Valve : Regulates the flow or pressure of a fluid, normally responding to signals generated by independent devices.
- Flow Meter : Measures mass flow rate of a fluid traveling through a tube. (The mass flow rate is the mass of the fluid traveling past a fixed point per unit time.)
- Pressure Sensor : Measures the pressure.

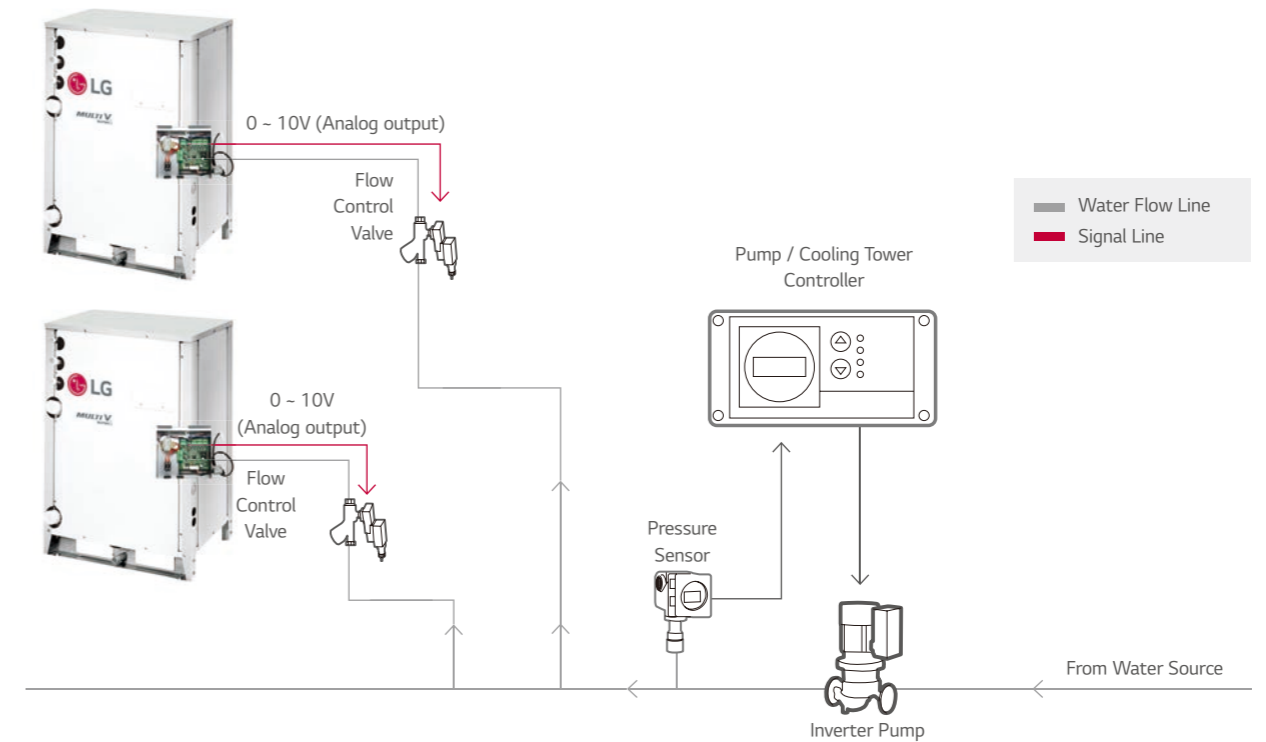

Low Ambient Kit

PRVC2

External integration module for cooling operation with -25 °C low ambient temperature.

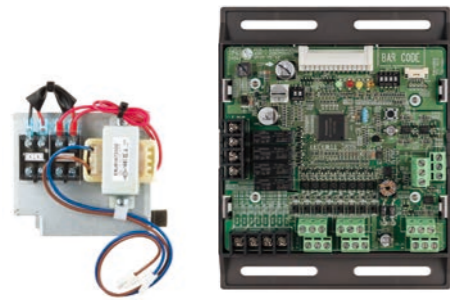

Features

Function

- 25 °C Low ambient cooling operation by Low ambient kit and hood with damper (Analog output 0 ~ 10V)
- Demand control
- Low noise operation
- Output outdoor or indoor unit operation status (AC 250V, Max. 1A)
- Output error status (AC 250V, Max. 1A)

Description

- Low ambient kit supports -25 °C cooling operation by making stable condensing pressure with reducing air flow rate from hood and damper control given 0 ~ 10V proportional to condensing pressure.
- Low ambient kit provides IO Module function.
- External snow hood and air damper are required for this item.
- Transformer and terminal block are included.

Models Applied

- MULTI V 5

Installation Scene

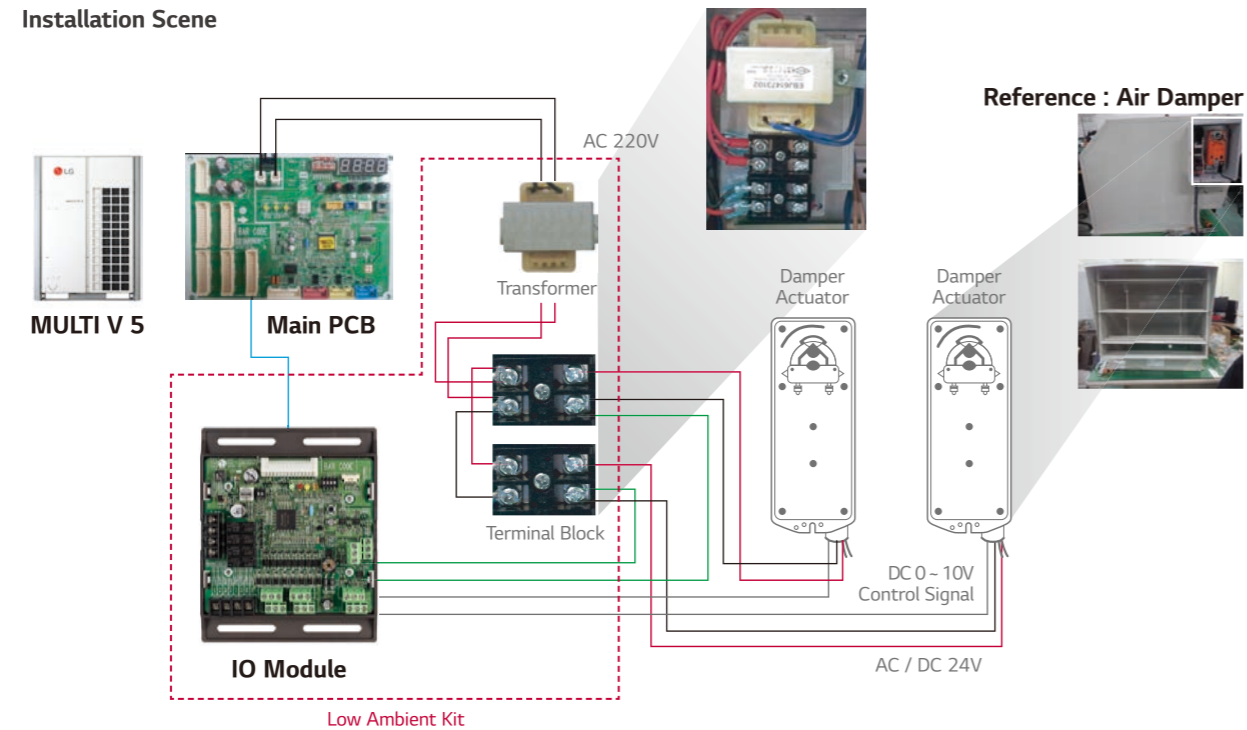

- Note
- Damper Actuator can accept only DC 24V power input.
 - Do not input AC power. Otherwise it will cause a serious damage.
 - The IO Module can control maximum three actuators.
 - Case of one valve, the slave signal connector must not use.
 - The power (AC / DC 24V) and signal (DC 0 ~ 10V) line is recommended by AWG22 (1/32 in, (0.644 mm), 0.016 Ω / ft (0.053 Ω / m)).

Cool / Heat Selector

PRDSBM

Cooling only, heating only, and fan mode can be selected.



Features

- Indoor unit mode control without central controller.
- Select operation mode : Cooling, Heating, Fan mode
- Mode lock for cooling & heating mixing error-proof during the change of season.

Models Applied

- MULTI V 5
- MULTI V IV
- MULTI V WATER S
- MULTI V WATER II
- MULTI V S
- MULTI V WATER IV
- MULTI V PLUS II, MULTI V PLUS

Fan Mode

Cooling only

Mode

Heating only



Installation Scene

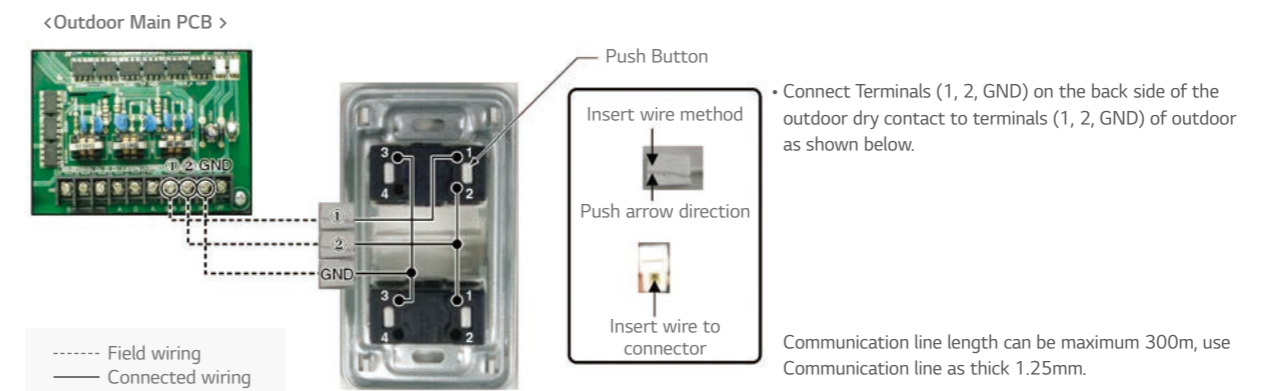

AHU Kit

A solution to connect LG's high efficiency system to the DX coil of an air handling unit for maximum energy savings.

COMMUNICATION KIT



PAHCMR000



PAHCMS000

CONTROL KIT



PAHCNM000

EEV KIT



PRLK048A0
PRLK096A0



PRLK396A0

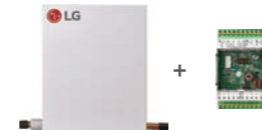

PRLK594A0

CONTROLLER MODULE

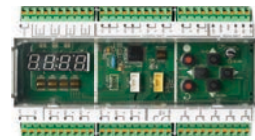

PAHCMM000

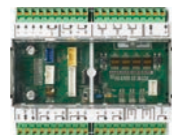

PAHCMC000

Specification

Control Application Kit

TYPE	MODEL	DIMENSIONS (MM)			POWER SUPPLY	IP RATING	DESCRIPTION
		W	H	D			
Communication Kit	PAHCMR000	300	300	155	1Ø, 220 ~ 240 V, 50 / 60 Hz	IP66	Return / Room air temperature control by DDC or LG individual / centralized controller.
	PAHCMS000	380	300	155	1Ø, 220 ~ 240 V, 50 / 60 Hz	IP66	Discharge air / Supply air temperature control by DDC or LG individual / centralized controller
Controller Module	PAHCMM000	162	90	61	DC 12V	IP20	Main Controller module
	PAHCMC000	108	90	61	DC 12V	IP20	Communication Controller module
Control Kit	PAHCNM000	500	500	210	1Ø, 220 ~ 240 V, 50 / 60 Hz		Various AHU control functions with multiple DX coils (Maximum connectable ODU is 3 units)

Expansion Application Kit

TYPE	MODEL	DIMENSIONS (MM)			PIPE DIAMETER (MM)		CAPACITY INDEX RANGE
		W	H	D	LIQUID		
EEV Kit	PRLK048A0	217	404	83		12.7	3.6 ~ 28 kW
	PRLK096A0	217	404	83		12.7	28.1 ~ 56 kW
	PRLK396A0	349.5	345.5	180		19.05	56.1 ~ 112 kW
	PRLK594A0	409.5	345.5	180		19.05	112.1 ~ 168 kW

Communication Kit

High Energy Efficiency

LG's DX AHU solutions' superior performance provides a highly efficient heat source system.

- High energy efficiency inverter system
- Large range of expansion application Kit : Max. 168 kW EEV Kit 1)
- Connected to various heat sources : MULTI V, MULTI V WATER, MULTI V S, SINGLE SPLIT

1) Maximum connectable EEV capacity for PAHCMR000, PAHCMC000 is 112 kW.

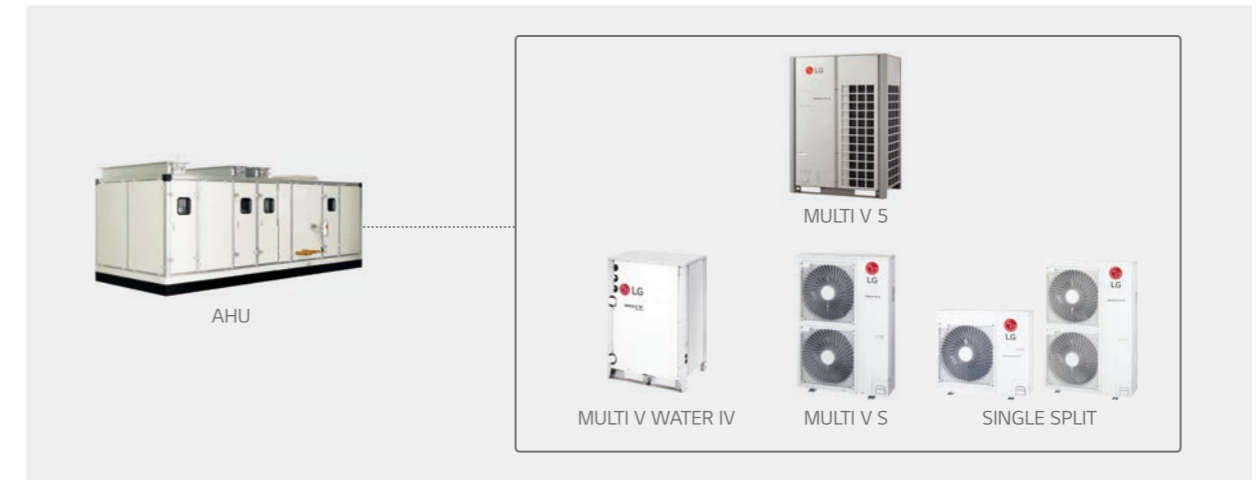

Diverse Options for Control

AHU communication kit can be connected to various control systems such as LG individual / central controller and DDC.¹⁾

It can be directly connected to DDC without separated controller, so DDC can receive product control and monitor information through contact signal or Modbus protocol.

- LG Individual / Central controller supported
 - LG controller stand alone or combination with DDC
- Direct wiring between DDC and AHU communication kit
 - Embedded Digital I / O and Analog Input
 - Modbus RTU protocol supported

1) DDC : Direct Digital Controller

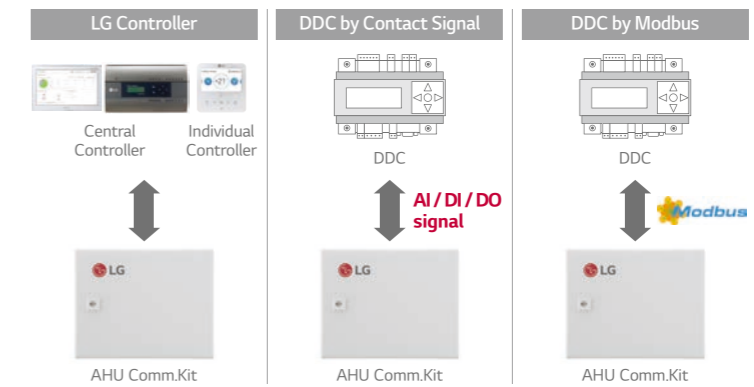

AHU Kit

Communication Kit

Expandable System Design

LG AHU system can be a suitable solution for various sites due to its application flexibility and wide range of line up with large capacity models. According to the required capacity, a single or multiple module combination is possible due to the AHU communication kit's modular design.

- Multiple module combination for large capacity AHU

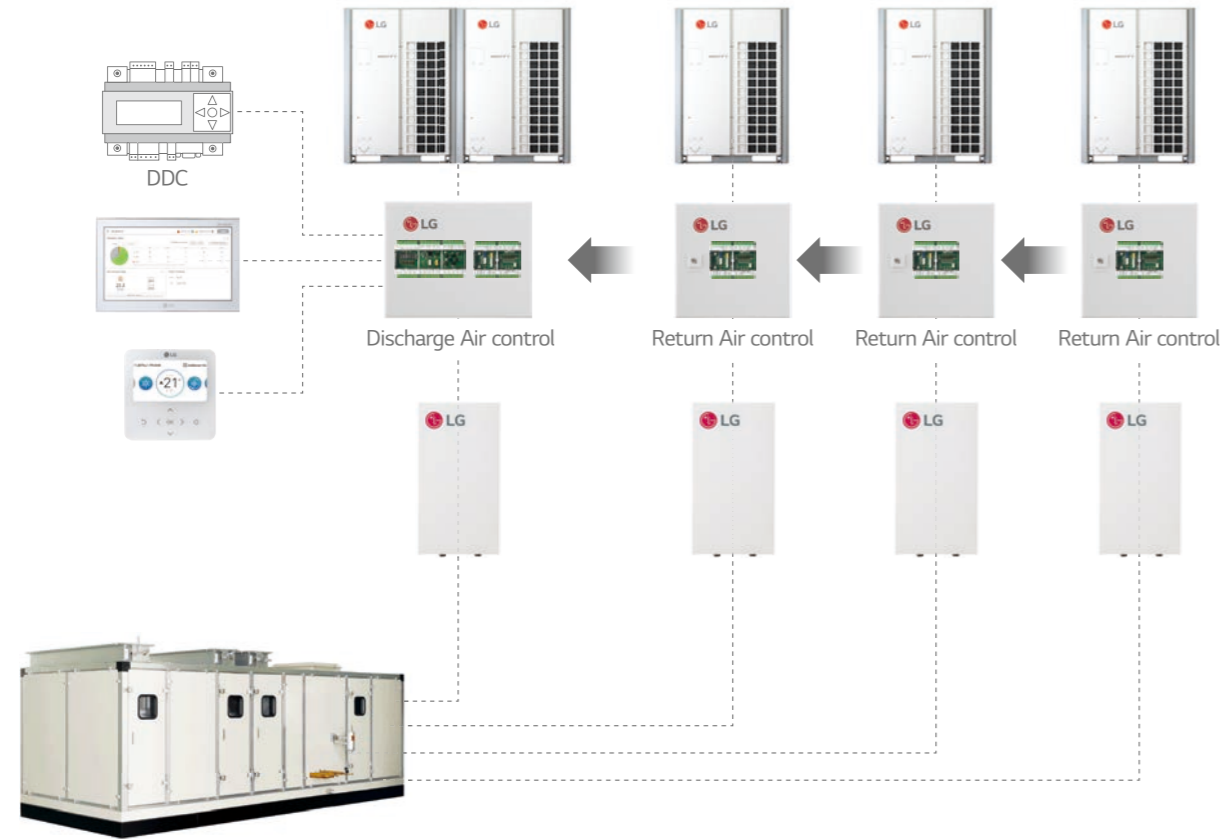

Communication Kit & Controller Module

Single Split Application

Single Split + Return / Room Air Temperature Control

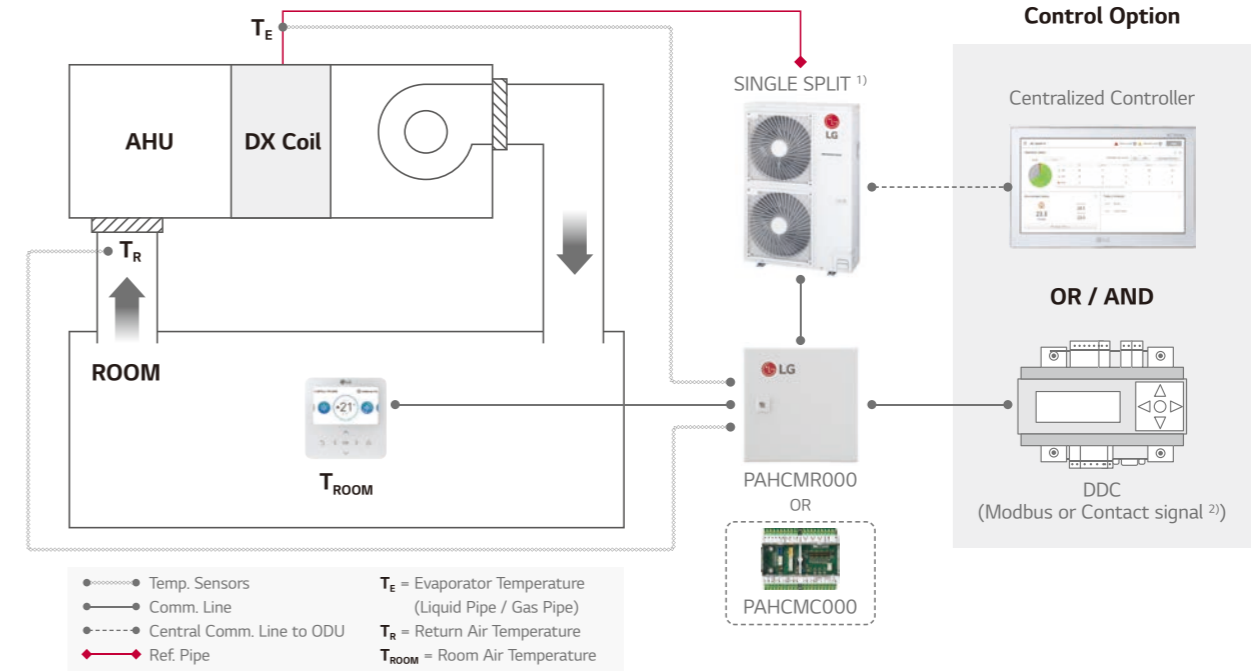

1) PI485 (PMNFP14A1) is required for centralized controller.
 2) In case of applying DDC with contact signal, discharge air temperature should be measured and controlled by DDC.
 Note : For more detail, please refer to the PDB.

Single Split Application

Single Split + Discharge Air Temperature Control

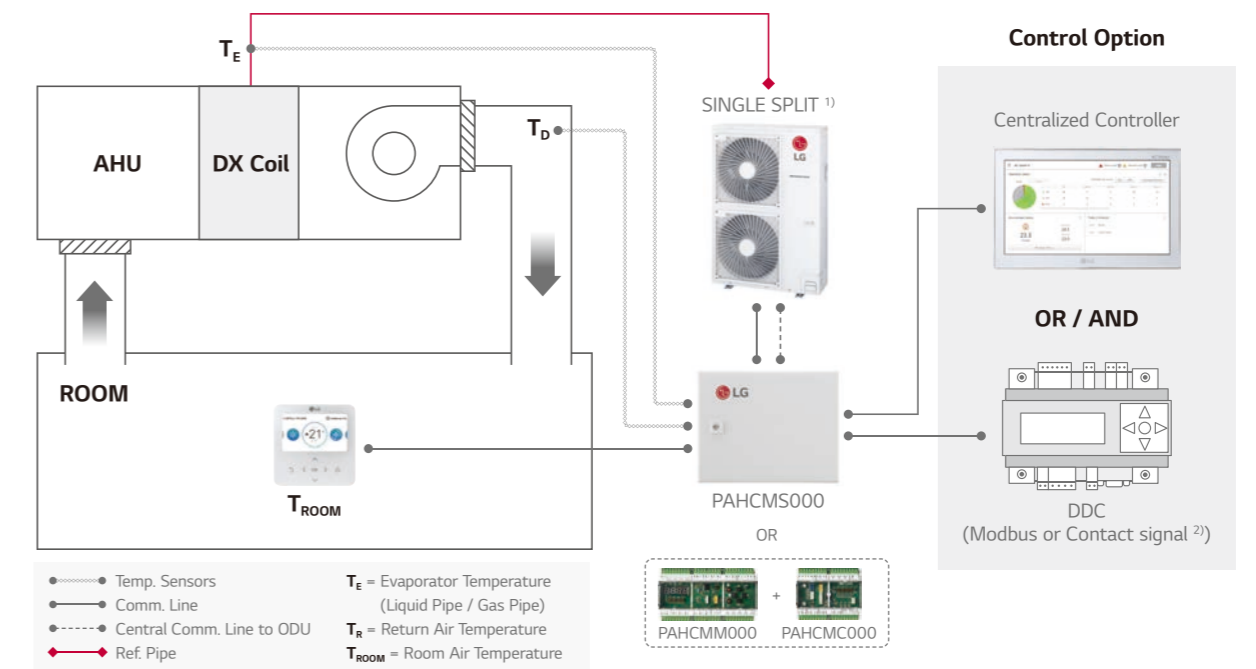

1) PI485 (PMNFP14A1) is required for centralized controller.
 2) In case of applying DDC with contact signal, discharge air temperature should be measured and controlled by DDC.
 Note : For more detail, please refer to the PDB.

AHU Kit

Communication Kit & Controller Module

MULTI V Application

MULTI V + EEV Kit + IDU + Return / Room Air Temperature Control

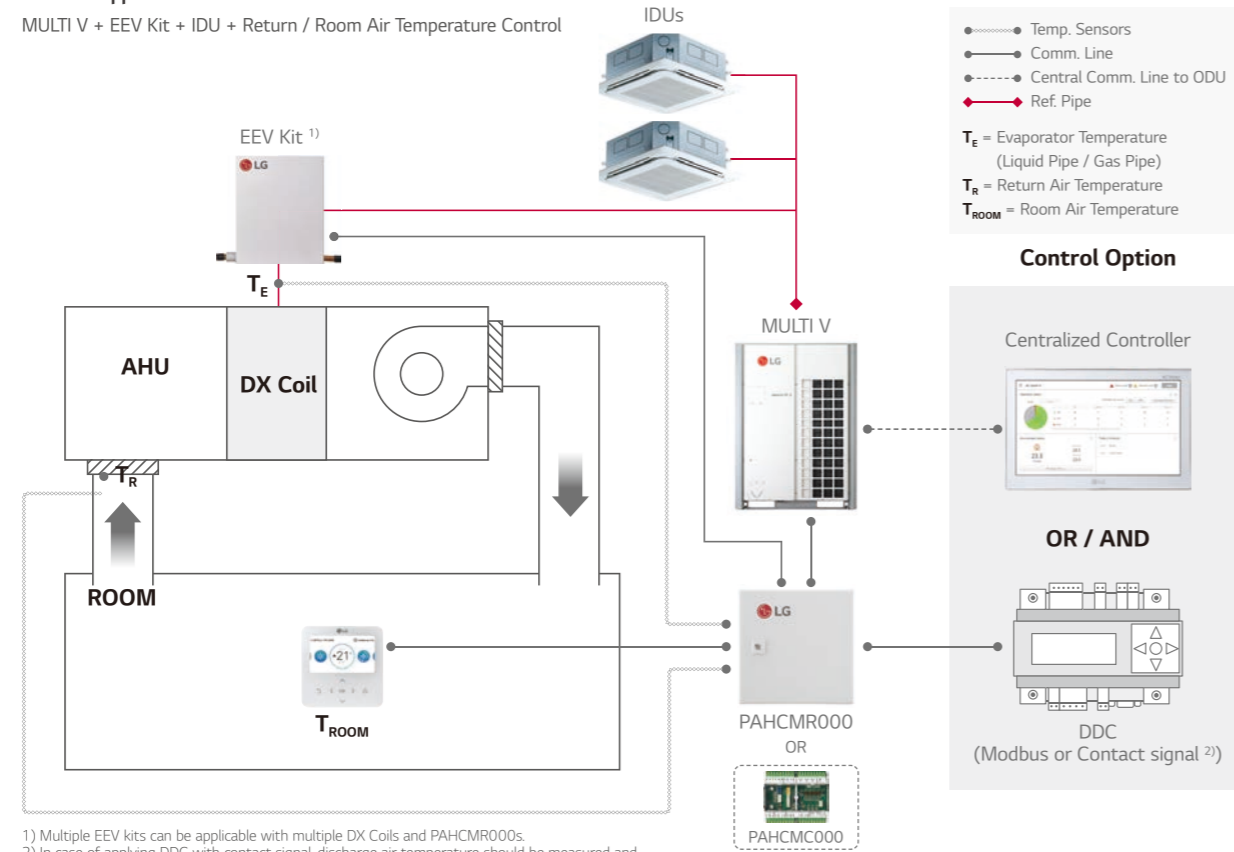

1) Multiple EEV kits can be applicable with multiple DX Coils and PAHCMR000s.
 2) In case of applying DDC with contact signal, discharge air temperature should be measured and controlled by DDC.
 Note : For more detail, please refer to the PDB.

MULTI V Application

MULTI V + EEV Kit + Discharge Air Temperature Control

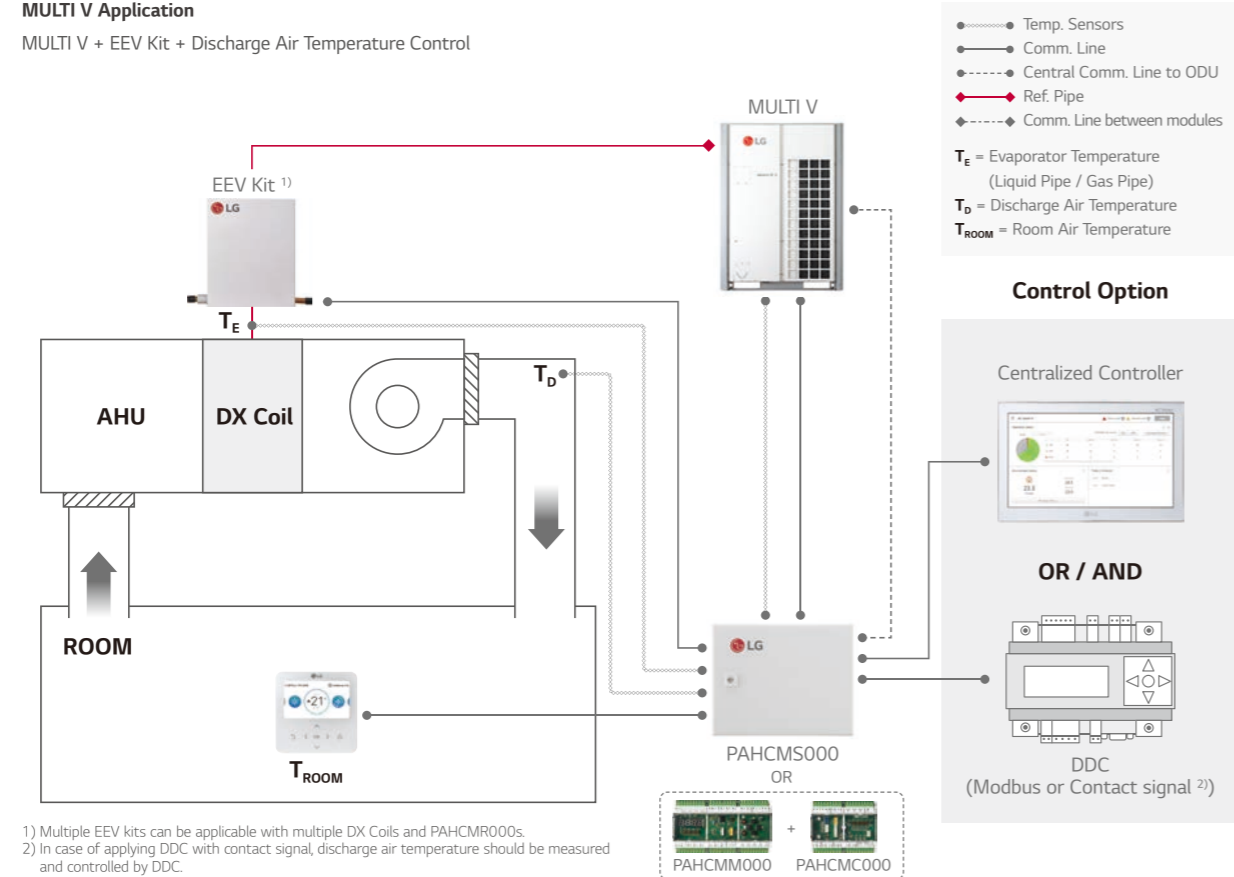

1) Multiple EEV kits can be applicable with multiple DX Coils and PAHCMR000s.
 2) In case of applying DDC with contact signal, discharge air temperature should be measured and controlled by DDC.
 Note : For more detail, please refer to the PDB.

Communication Kit Function

Communication with DDC via Contact Signal

FUNCTION LIST	PAHCMR000 (PAHCMC000)	PAHCMS000 (PAHCMM000 + PAHCMC000)	TYPE	NOTE
Operation On / Off	On / Off	On / Off	Digital Input (Non Voltage)	-
Operation Mode	Cooling / Heating	Cooling / Heating	Digital Input (Non Voltage)	Available operation mode can vary depending on the settings of Communication Kit
Return (Room) Air Temperature ²⁾	16 ~ 30 °C	-	Analog Input (DC 0 ~ 10 V / 20mA)	-
Control ¹⁾ Discharge Air Temperature ²⁾	-	-	-	Discharge air temperature should be controller directly by DDC using 'ODU Capacity Control'
Fan Speed ³⁾	-	High / Middle / Low	Digital Input (Non Voltage)	-
Forced Thermal	On / Off	-	Digital Input (Non Voltage)	-
ODU Capacity	-	10 ~ 100%	Analog Input (DC 0 ~ 10 V / 20mA)	-
Emergency Stop	-	Stop / Normal	Digital Input (Non Voltage)	-
Monitor Operation	On / Off	On / Off	Digital Output (Max. : DC 30 V / 1 A, AC 250V / 1 A)	For PACHMR000, dip sw1-3 DO Type should be set 'Off' (Status), In this case, 'fan speed' cannot be monitored by DO ports
Monitor Operation Mode	-	-	-	It needs to be checked through control signal
Monitor Fan Speed	High / Middle / Low	High / Middle / Low	Digital Output (Max. : DC 30 V / 1 A, AC 250V / 1 A)	For PACHMR000, dip sw1-3 DO Type should be set 'On' (Fan Mode) In this case, 'On / Off, defrost, error Status' cannot be monitored by DO ports
Monitor Defrost Operation	Defrost / Normal	Defrost / Normal	Digital Output (Max. : DC 30 V / 1 A, AC 250V / 1 A)	For PACHMR000, dip sw1-3 DO Type should be set 'OFF' (Status), In this case, 'fan speed' cannot be monitored by DO ports
Monitor Error Alarm	Error / Normal	Error / Normal	Digital Output, Relay C contact (Max. : DC 30 V / 1 A, AC 250V / 1 A)	-
Monitor Compressor On / Off	-	On / Off	Digital Output, (Max. : DC 30 V / 1 A, AC 250V / 1 A)	-

1) Control functions for LG individual and central controller are not available in case of using together with DDC via contact signal.
 2) The range of temp. is differ depending on the type of the controller.
 3) To control fan speeds, DO port of the fan speed status should be connected to the fan control panel.
 Note : For more detail information, please refer to the product data book.

Communication with DDC via Modbus protocol

FUNCTION LIST	PAHCMR000 (PAHCMC000)	PAHCMS000 (PAHCMM000 + PAHCMC000)	NOTE
Operation On / Off	On / Off	On / Off	
Operation Mode	Cooling / Heating / Fan	Cooling / Heating / Fan	
Return (Room) Air Temperature	16 ~ 30 °C	-	
Control ¹⁾ Discharge Air Temperature ²⁾	-	○	Dip SW1-2 Discharge Temp. Control Type should be set 'On' Standard II : 16 ~ 30 °C Standard III ⁴⁾ : 12 ~ 50 °C
Control ¹⁾ Fan Speed ³⁾	High / Middle / Low	-	
Control ¹⁾ Forced Thermal On / Off	-	-	
Control ¹⁾ ODU Capacity Control ²⁾	-	10 ~ 100%	Dip SW1-2 Discharge Temp. Control Type should be set 'On'
Control ¹⁾ Emergency Stop	-	-	
Monitor Operation	On / Off	On / Off	
Monitor Operation Mode	Cooling / Heating / Fan	Cooling / Heating / Fan	
Monitor Return (Room) Air Temperature	○	-	Corresponding air temperature sensor connected to AHU Comm.Kit is required
Monitor Discharge Air Temperature	-	○	
Monitor Fan Speed	High / Middle / Low	High / Middle / Low	
Monitor Defrost Operation	Defrost / Normal	Defrost / Normal	
Monitor Error Alarm	Error / Normal, Error code	Error / Normal, Error code	
Monitor Compressor On / Off	On / Off	On / Off	

※ ○ : Applied, - : Not Applied
 1) Control functions for LG individual and central controller are not available in case of using together with DDC via contact signal.
 2) In case of PAHCMS000, control type between "Discharge Air Temperature" and "ODU Capacity Control" is selectable.
 3) To control fan speeds, DO port of the fan speed status should be connected to the fan control panel.
 4) Standard III wired remote controller after version 2.10.5a.
 Note : For the Modbus memory map and more detail information, please refer to the product data book.

AHU Kit

Communication Kit Function

With LG Control System (Individual & Centralized Controller)

FUNCTION LIST	PAHCMR000 (PAHCMC000)	PAHCMS000 (PAHCMM000 + PAHCMC000)	NOTE
Operation On / Off	On / Off	On / Off	-
Operation Mode	Cooling / Heating / Fan	Cooling / Heating / Fan	Available operation mode can vary depending on the settings of Communication Kit
Return (Room) Air Temperature ²⁾	16 ~ 30 °C	-	-
Discharge Air Temperature ²⁾	-	○	Standard II : 16 ~ 30 °C Standard III ⁴⁾ : 12 ~ 50 °C Central Controllers : 12 ~ 50 °C
Fan Speed ³⁾	High / Mid / Low	High / Mid / Low	To control the AHU fan, dip switch 1-3 'DO type' should be set 'On (Fan Speed)' (PAHCMR000)
Operation	On / Off	On / Off	-
Operation Mode	Cooling / Heating / Fan	Cooling / Heating / Fan	-
Return (Room) Air Temperature	○	-	-
Discharge Air Temperature	-	○	Standard II : 11 ~ 39.5 °C Standard III ⁴⁾ : 0 ~ 100.0 °C Central : -50.0 ~ 100.0 °C
Fan Speed	High / Middle / Low	High / Middle / Low	-
Defrost Operation	On / Off	On / Off	Only with Individual Controller
Error Alarm	Error Code	Error Code	Error code will be displayed on the screen
Compressor On / Off	On / Off	On / Off	Only with Individual Controller

※ ○ : Applied, - : Not Applied

- Control functions for LG individual and central controller are not available in case of using together with DDC via contact signal.
- The range of setting temperature is different depending on the type of the controllers. And operation may different from setting range.
- To control fan speeds, DO port of the fan speed status should be connected to the fan control panel.
- Standard III wired remote controller after version 2.10.5a.

Note : For more detail information, please refer to the product data book.

Compatibility with LG HVAC Controllers

CONTROLLER	INDIVIDUAL CONTROLLER			CENTRALIZED CONTROLLER					BMS GATEWAY	PDI
	PREMIUM	STANDARD III	STANDARD II	AC EZ	AC EZ TOUCH	AC SMART 5	ACP 5	AC MANAGER 5 ¹⁾	ACP LONWORKS	PREMIUM STANDARD
Model no.	PREMTA000 PREMTA000A PREMTA000B	PREMTB100 PREMTBB10	PREMTB001	PQCSZ250S0	PACEZA000	PACSSA000	PACPSA000	PACMSA000	PLNWKB000	PQNUD1S40 PPWRDB000
PAHCMR000	○	○	○	○	○	○	○	○	○	○
PAHCMS000	-	○ ²⁾	○	-	-	○	○	○	-	-

※ ○ : Applied, - : Not Applied

- AC Manager 5 is an integrator, so the installation with AC Smart 5 or ACP 5 is required.
 - Set temperature range of this model shall be extended April, 2020.
- Note : 1. Dry contact for indoor unit (PDRYCB000 / 400 / 300 / 500) is not applied.
2. For more details, please refer to the product data book.

Outdoor Unit Compatibility

For Small Size Application (~ 15kW) - Single Split

TYPE	MODEL	UUA1 (2.5 ~ 5.0 KW) ¹⁾	UUB1 (5.0 ~ 8.0 KW) ¹⁾	UUC1 (7.1 ~ 10.0 KW) ¹⁾	UUD1 / UUD3 (10.0 ~ 15.0 KW) ¹⁾
Communication Kit (Controller Module)	PAHCMR000 (PAHCMC000)	-	○	○	○
	PAHCMS000 (PAHCMM000 + PAHCMC000)	-	○	○	○
Control Kit	PAHCNM000	-	-	-	-

1) When connecting to Single Split outdoor unit, please check the compatibility to the regional sales office.

For Medium-Large Size Application (~ 672 kW) - MULTI V

TYPE	MODEL	MULTI V				MULTI V WATER	
		5	IV	III	S	IV	II
Communication Kit (Controller Module)	PAHCMR000 (PAHCMC000)	○	○	○	○	○	○
	PAHCMS000 (PAHCMM000 + PAHCMC000)	○	○	○	○	○	○
Control Kit	PAHCNM000	○	○	○	○	○	○

EEV Kit Compatibility

EEV KIT MODEL	CAPACITY INDEX (kW)		AHU APPLICATION KITS (MAXIMUM CONNECTABLE EEV KITS)			CONNECTION BY ODU SYSTEM		
	MIN.	MAX.	PAHCMR000 (PAHCMC000)	PAHCMS000 (PAHCMM000 + PAHCMC000)	PAHCNM000	MULTI V		SINGLE SPLIT
					HEAT PUMP		HEAT RECOVERY	
PRLK048A0	3.6	28	○ (1)	○ (1)	○ (6)	○	○	-
PRLK096A0	28.1	56	○ (1)	○ (1)	○ (6)	○	○ (Max. 33.7 kW)	-
PRLK396A0	56.1	112	○ (1)	○ (1)	○ (6)	○	-	-
PRLK594A0	112.1	168	-	○ (1)	○ (3)	○	-	-

※ ○ : Applied, - : Not applied

- Table of the outdoor unit compatibility is based on European regional model.
- When connecting outdoor units in other areas, please check whether they are compatible or not.
- Expansion application kit compatibility is based on capacity index of the system, it may changed according to system design condition.

AHU Kit

Control Kit

Field Supplied Item

LIST	REQUIRED SPECIFICATION	APPLY LOCATION
Temperature / Humidity Sensor	- Power : AC 24 V - Output signal : DC 0 ~ 10 V - Temperature range : -40 °C ~ 70 °C - Humidity range : 0 ~ 95 % RH	Supply air duct, Return air duct, Outdoor air duct
Temperature Sensor	- Power : AC 24 V - Output signal : DC 0 ~ 10 V - Temperature range : -50 °C ~ 50 °C	Supply air duct, Return air duct, Mixed air duct
Damper Actuator	- Power : AC 24 V - Input / output signal : DC 0 ~ 10 V - Torque : 15 N·m - Operation time : 150 s - Rotation Angle : 90°	Outdoor air damper, Exhaust air damper, Mixed damper
Filter Differential Pressure Sensor	- Power : AC 24 V - Output signal : DC 0 ~ 10 V - Range: 0 ~ 1,000 Pa - Switch type : Relay open / close	Filter
Static Pressure Sensor	- Power : AC 24 V - Output signal : DC 0 ~ 10 V - Range : 0 ~ 1,000 Pa	Supply air duct
CO2 Sensor	- Power : AC 24 V - Output signal : DC 0 ~ 10 V - Range : 0 ~ 2,000 ppm	Return air duct
Smoke Detector	- Power : AC 24 V - Type : Contact	Return air duct

Various Control with Control Kit – Multiple MULTI V + EEV Kits

Field Supplied Item

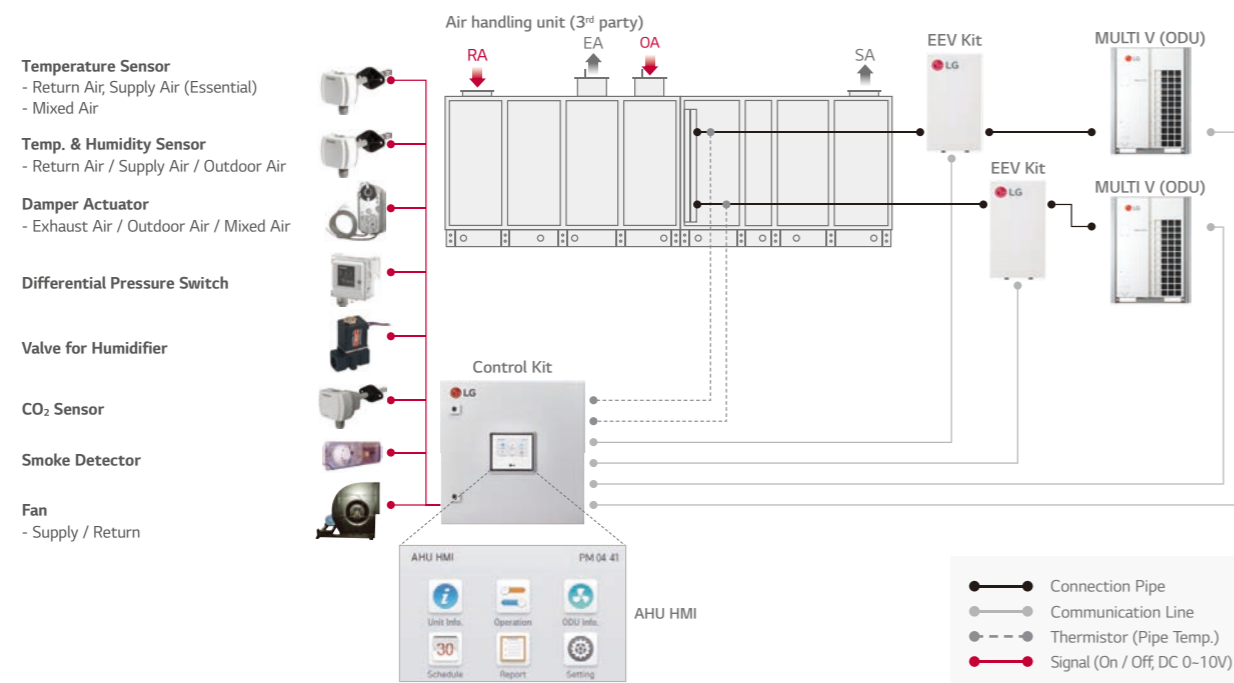

Water Communication Module

PAHCMW000

This module is intended to connect 3rd party plate heat exchanger to LG outdoor unit with the ability to control water temperature from 3rd party DDC or LG remote controller.



Overview

Interlocking with 3rd parties can make various solution with LG Multi V outdoor unit.

1. EEV
2. Solenoid Valve (NC)
3. Non-Return Valve
4. FS : Flow Switch
5. TT : DHW Temperature Transmitter

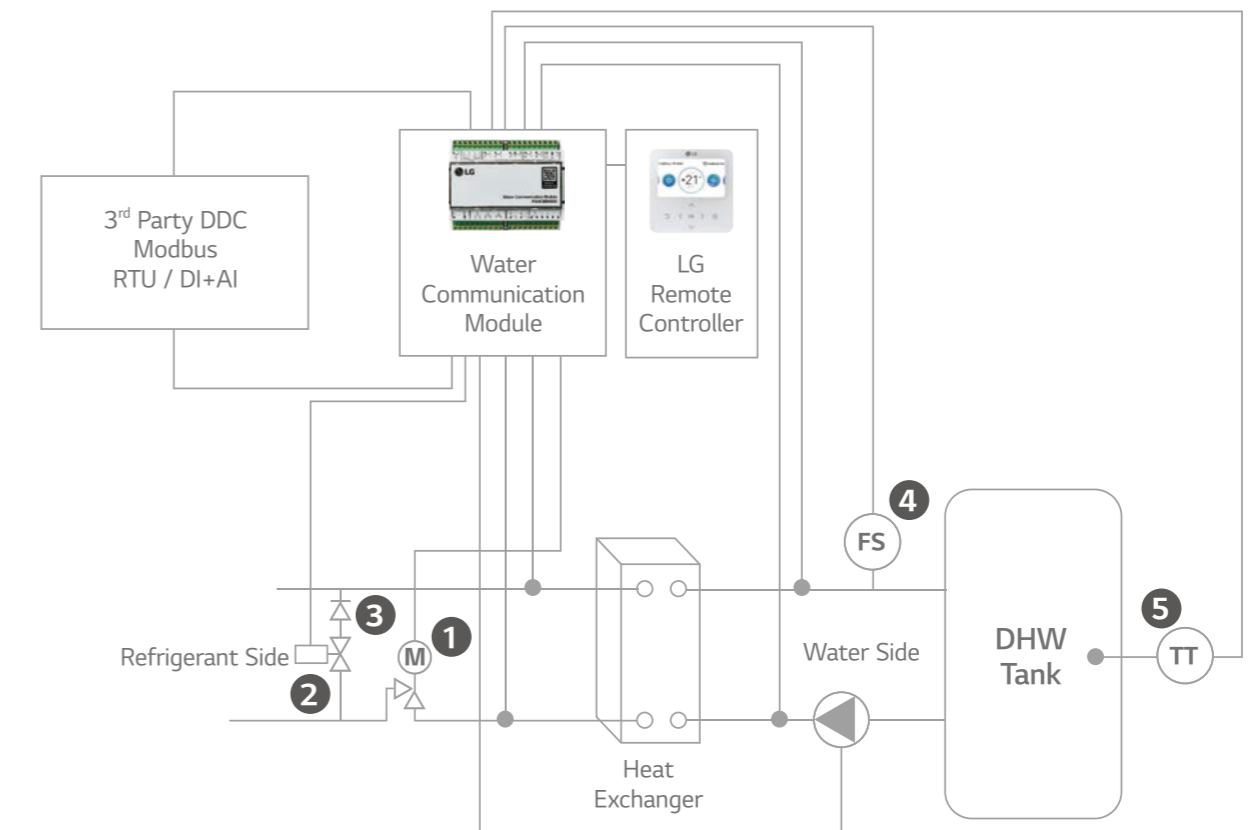

• 3rd party solenoid, non-return valve, heat exchanger, flow switch and DHW temperature transmitter (Optional) must be purchased separately. (Field supplied items)

Water Communication Module

Features & Benefits

Interlocking with 3rd parties can make various solution with LG MULTI V outdoor unit.

Interlocking with 3rd Party Equipment

CONTENTS	CONNECTION PORT		FUNCTION
RS485	CH1 (A+ / B-)	Module Comm. Port	Communication Port Modbus
	CH2 (A+ / B-)	IDU Comm. Port	Communication with Multi V Outdoor
UNIVERSAL INPUT (Cooling / Heating Setting)	UI1	Flow Switch	Flow Switch Input by 3rd party
	UI2	0 ~ 10V Set Temp.	Target Temp. Setting
	UI3	Cooling Thermostat Signal	Thermostat Cooling Signal
	UI4	Heating Thermostat Signal	Thermostat Heating Signal
UNIVERSAL INPUT (DHW Only)	UI1	Flow Switch	Flow Switch Input by 3rd party
	UI2	0-10V Set Temp.	Target Temp. Setting
	UI3	DHW Temperature Transmitter 0 ~ 10V	Measured Water Temp. Input by 3rd party 0 ~ 10 V sensor
	UI4	DHW Thermostat Signal	DHW Heating Signal
NTC	RI1	Water Inlet Sensor	PHEX Water Inlet Sensor
	RI2	Water Outlet Sensor	PHEX Water Outlet Sensor
REMO	+12V / SIG / GND	LG Remote Controller	-
SINGLE	Reserved	-	-
DIGITAL OUTPUT	DO1	Defrost / Mode	Output for defrost signal and / or cool mode
	DO2	Pump	Output signal for pump on / off
	DO3	Bypass	Output signal for PHEX Bypass Valve
NTC	RI3	Thermistor Pipe In	PHEX Ref. Inlet Pipe Sensor
	RI4	Thermistor Pipe Out	PHEX Ref. Outlet Pipe Sensor
EEV	+12V / 1 / 2 / 3 / 4	Expansion Valve	EEV Control

Compatibility & Accessory

EEV (LG MODEL)

MODEL	CAPACITY (KW)		PAHCMW000
	MIN.	MAX.	
PAEEVC000	3.6	28	HP / HR
PRLK048A0	3.6	28	HP / HR
PRLK096A0	28.1	56	HP

Note : Water communication module can accept plate heat exchangers from 3, 6 to 112 kW for combination with Multi V Outdoor units.

LG Controllers

CONTROLLER	INDIVIDUAL CONTROLLER	CENTRALIZED CONTROLLER		DRY CONTACT
	HEATING STANDARD III	AC EZ TOUCH	AC SMART 5	
	PREMTW101	PACEZA000	PACSSA000	PDRYCB000

Specification for Field supply item

- The 3rd party can select the for best usable version

Solenoid valve for Bypass

CAPACITY (KW)		EEV TYPE	SYSTEM	KV VALUE OF SOLENOID AND NON-RETURN VALVE	PIPE SIZE
MIN.	MAX.				
3.6	28	PAEEVC000	HP / HR	0.95	3 / 8" / 9.52mm
		PRLK048A0			
28	56	PRLK096A0	HP	1.9	1 / 2" / 12.7mm

Flow switch

- The nominal flow and cut of flow can be calculated using the values below.

CONTROLLER	NOMINAL FLOW	FLOW SWITCH CUT OFF
L / min*kW	3.29	1.23

* Example : ODU nominal Cooling Capacity 28 kW, 28 x 3.29 = 92.12 L / min. nominal flow, 28 x 1.23 = 34.44 L / min. flow switch cut off

Installation Scene with Contact Connection

Contact signal + DHW Only Setting

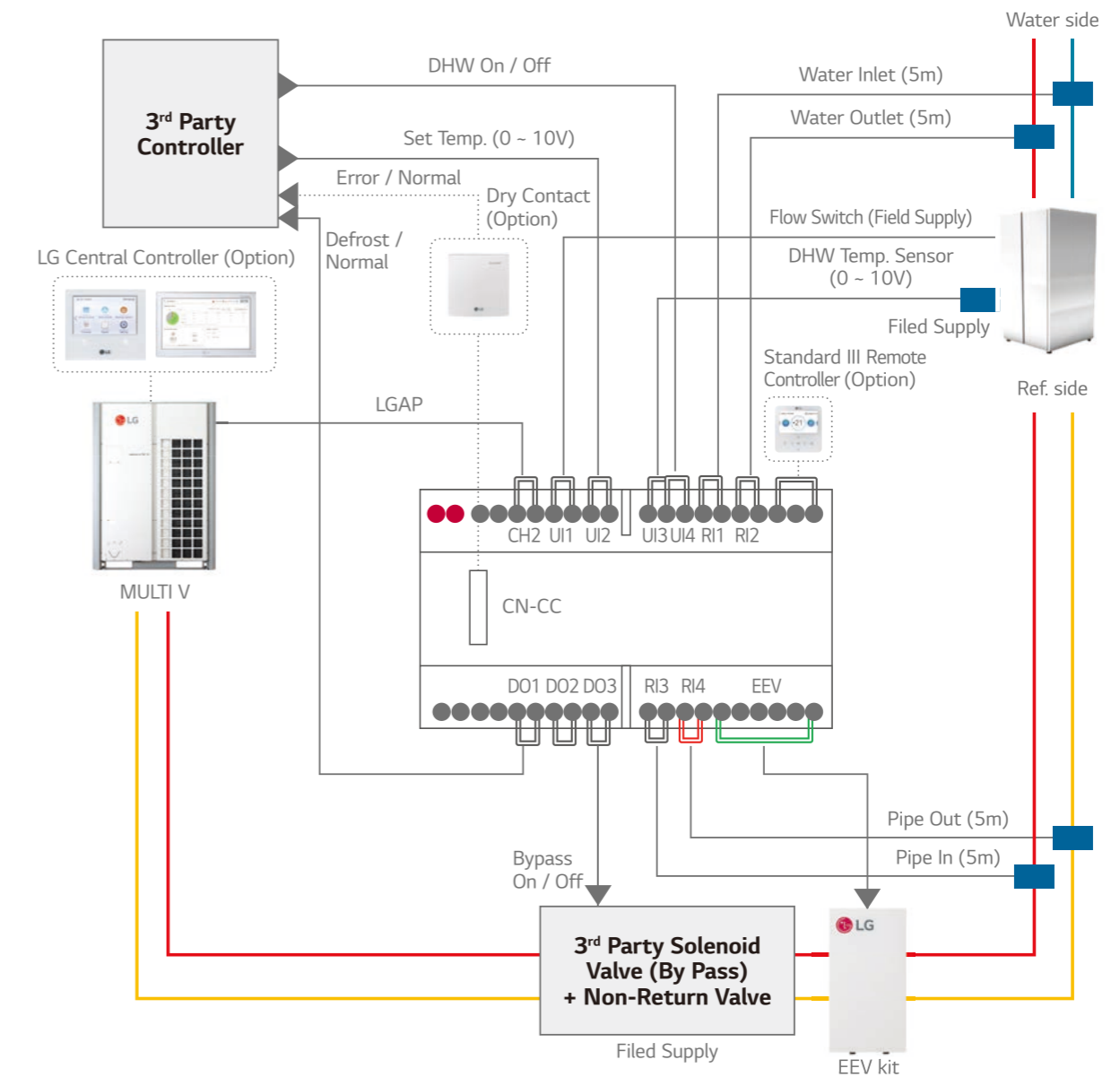

Water Communication Module

Installation Scene with Contact Connection

Contact signal + Heating / Cooling Setting

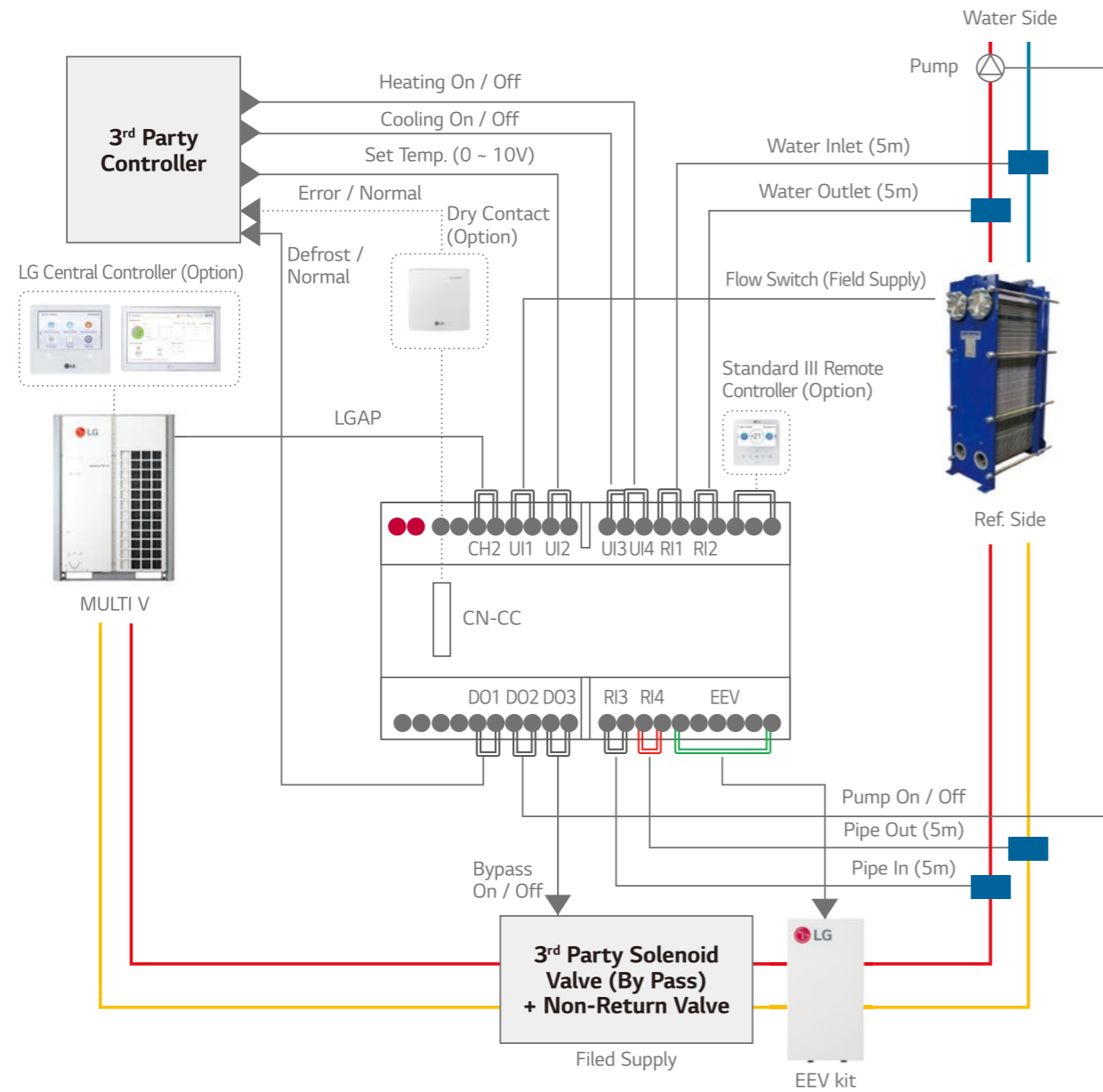

Installation Scene with Modbus / LG Control (Optional) Connection

Modbus + DHW Only Setting

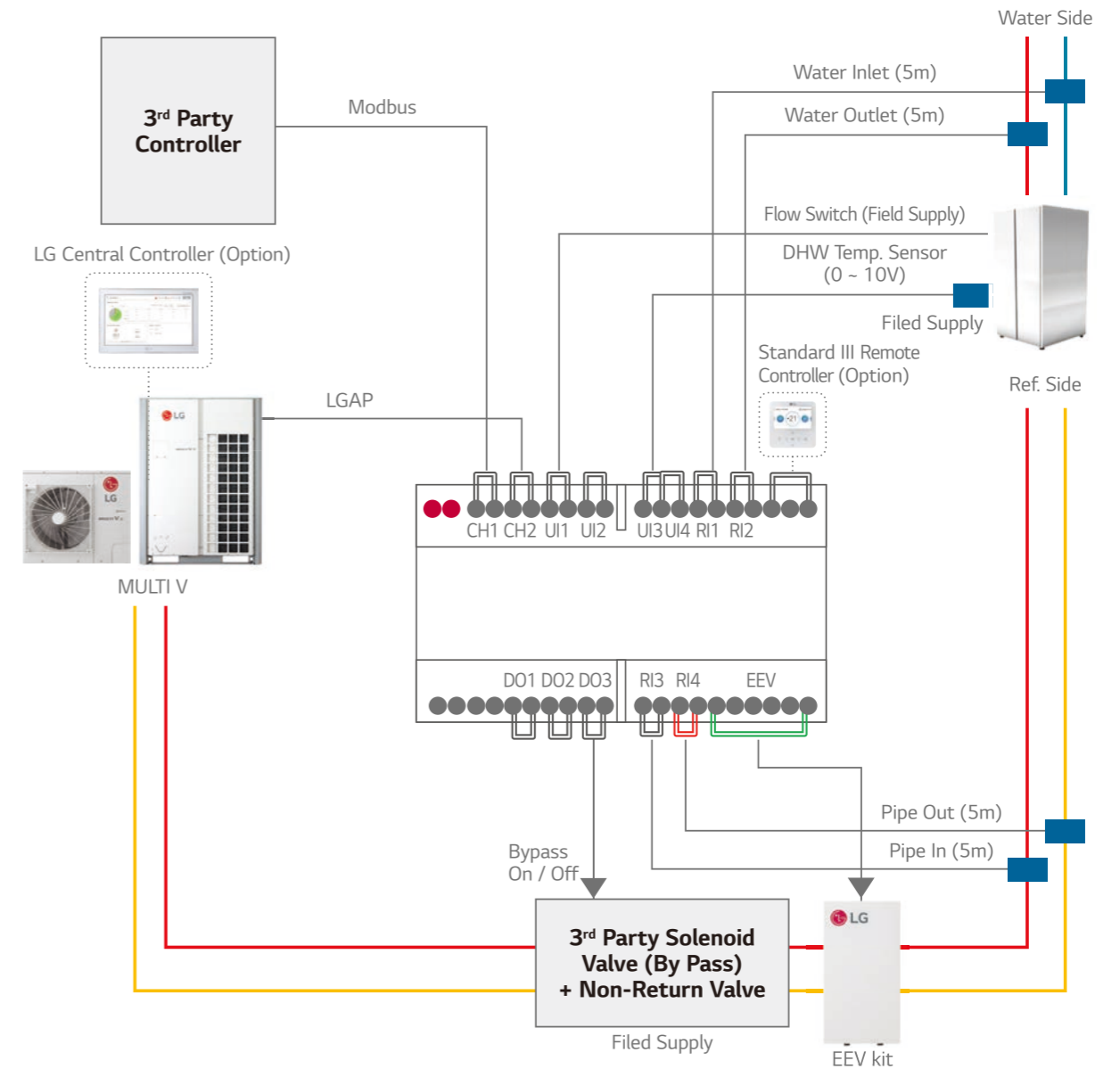

※ In case of Contact control, LG controllers can only support monitoring functions.

Water Communication Module

Installation Scene with Modbus / LG Control (Optional) Connection

Modbus + Heating / Cooling Setting

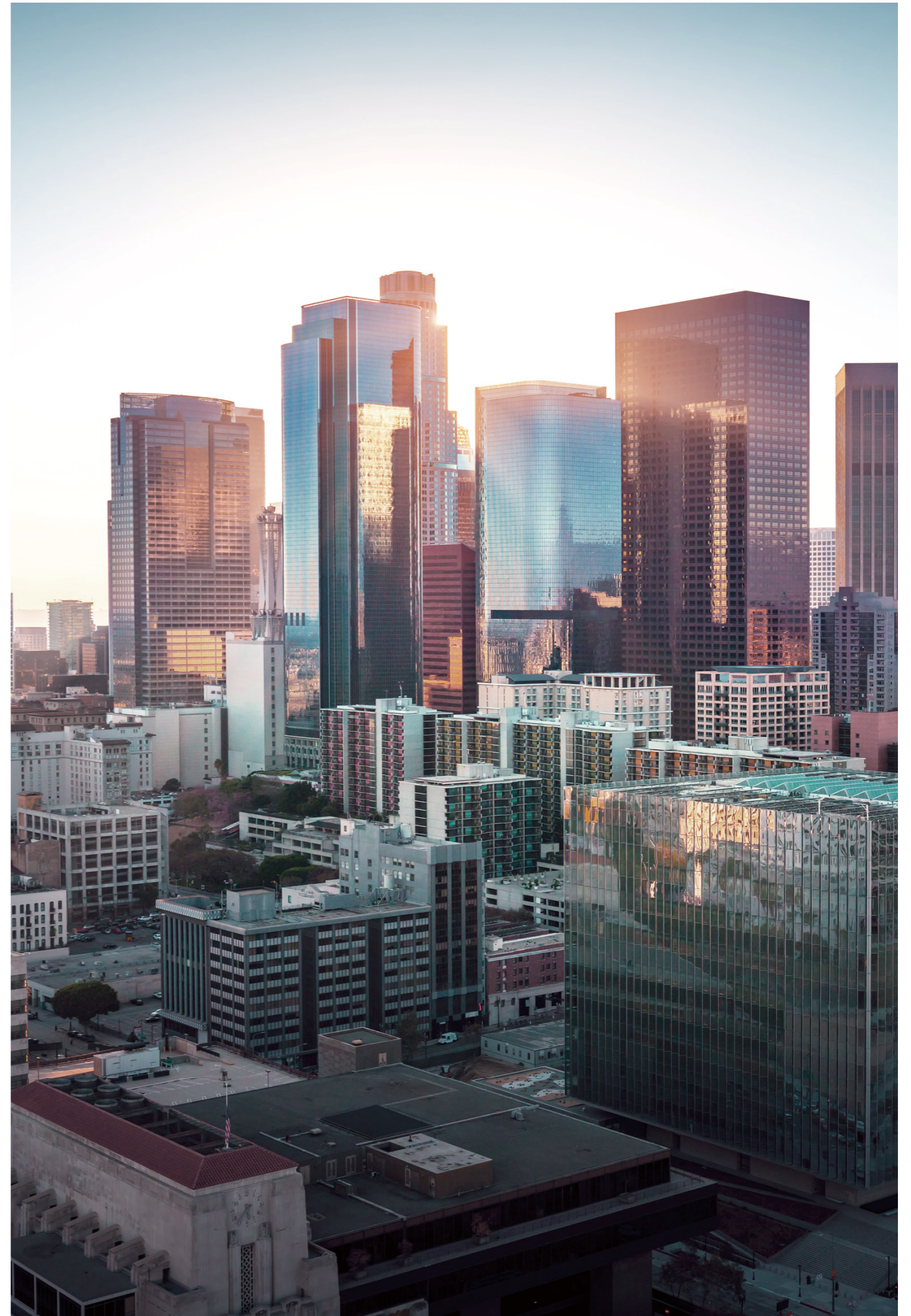
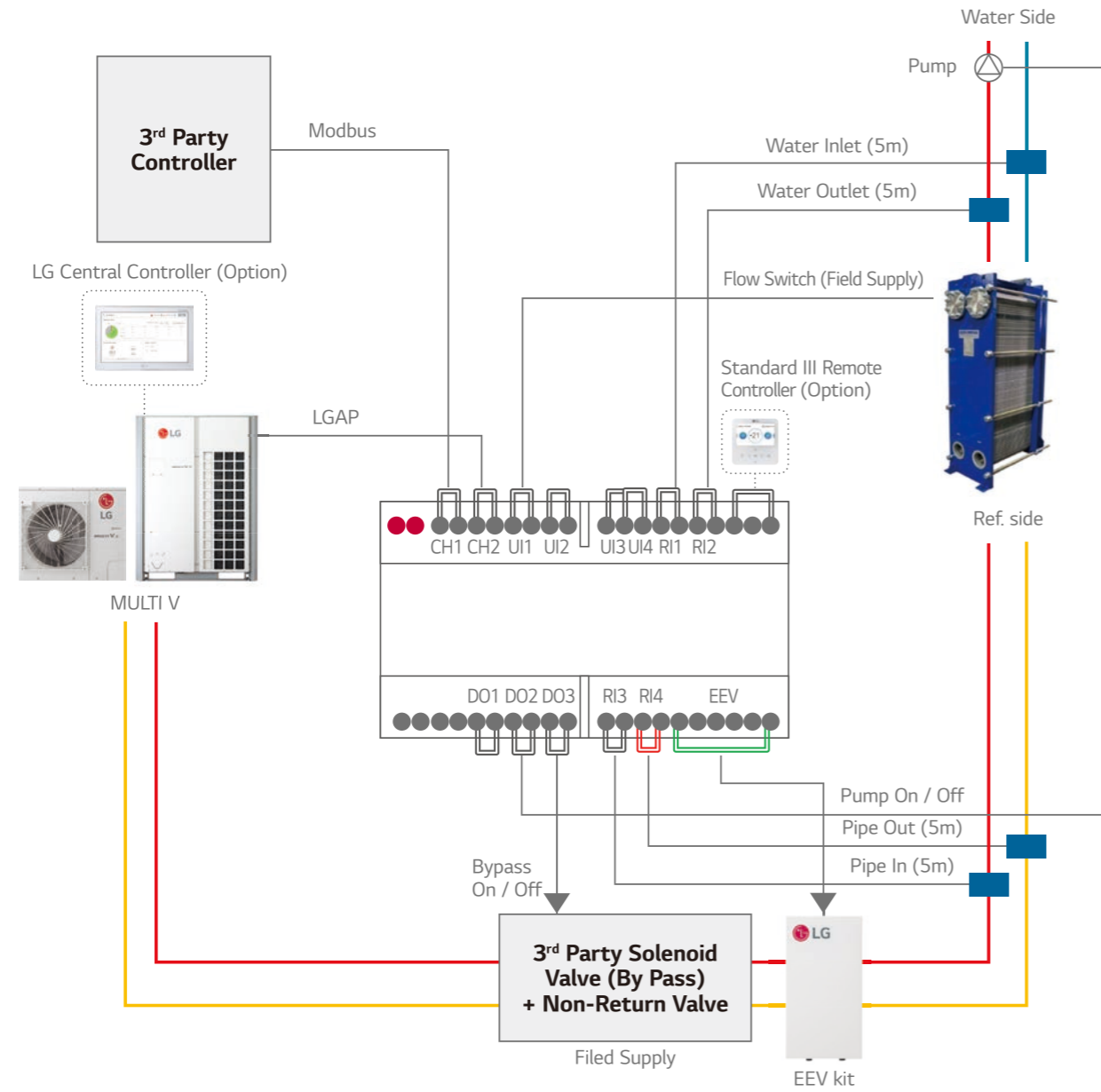

Hotel Control Solution

Guest Room
 Air conditioner automatically switches off when guests depart
 Integrated control of air conditioner with the hotel room controller
 Air conditioner can be controlled with existing hotel thermostat
 Prioritizes guest safety with refrigerant leak detection

Reception
 Air conditioner control in conjunction with check-in or check out

Public Areas
 Centralized management of the public areas

Design Proposal

GUEST ROOM				LOBBY
The air conditioner automatically turns off when guests leave	Integrated control of air conditioner with the hotel room controller	Control with existing hotel thermostat	Guest safety is the first priority	Air conditioner control in conjunction with check-in or check out
PDRYCB400 2 contact point	PDRYCB500 Modbus RTU (9,600bps)	PDRYCB320 8 contact point	PRLDNV50 Refrigerant leakage detector • 6,000ppm	PAC5A000 AC Smart 5 • BMS Integration (BACnet IP, Modbus TCP)
Input • Operation On / Off	Function • Operation • Indoor temperature • Error alarm • Set run mode • Set temperature • Set fan speed	Input • Universal Input • Operation On / Off • Thermo On / Off • Operation mode (Fan / Heat / Cool) • Fan speed (Low / Middle / High)		
Output • Operation On / Off status • Error alarm		Output • Operation On / Off status • Error alarm	PREMTB100 Wired remote controller • 4.3 inch color LCD • Touch button	PACP5A000 ACP 5 • BMS Integration (BACnet IP, Modbus TCP)

Shopping Mall Control Solution

Retail
 Proportionally distribute and manage the power consumption by tenants
 Real-time system issue detection and alarms

Maintenance Office
 Reduces energy by checking operational trends

Atrium
 Integrated management of AHU applied to large spaces
 Chiller and VRF integrated control

Design Proposal

RETAIL	MAINTENANCE OFFICE	ATRIUM	
Proportionally distribute and manage power consumption by the tenant	Fast problem detection and alarms	Integrated management of AHU applied to large spaces	Chiller and VRF integrated control
PPWRDB000 PDI Standard (2 ports) • Max. 128 IDU	PAC5A000 AC Smart 5 • BMS Integration (BACnet IP, Modbus TCP)	PAHCMR000 AHU Comm.Kit • Return air	PCHLLN000 Chiller Option Kit + PACP5A000 PAC5A000 ACP 5 AC Smart 5
PQNUD1S40 PDI Premium (8 ports) • Max. 128 IDU	PACP5A000 ACP 5 • BMS Integration (BACnet IP, Modbus TCP)	PAHCMS000 AHU Comm.Kit • Discharge air	

Hospital Control Solution

Hospital Ward
Proper airflow management for patients
Monitor the comfort level for each hospital ward
Control fan speed and air volume

Service Zone
Energy savings based on flexible scheduling

Lobby
Centralized management of AHU for large spaces

Design Proposal

HOSPITAL WARD			SERVICE ZONE	LOBBY
Proper airflow management for patients	Monitor the comfort level for each hospital ward	External device interlock control	Energy savings based on flexible scheduling	Centralized management of AHU for large space
PTVSM A0 Human detection sensor	PACSS A000 AC Smart 5 • BMS Integration (BACnet IP, Modbus TCP)	PDRYCB400 2 contact point Input • Operation On / Off Output • Operation On / Off status • Error alarm	PACSS A000 AC Smart 5 • BMS Integration (BACnet IP, Modbus TCP)	PAHCMR000 AHU Comm.Kit • Return air
PREMTB100 Wired remote controller • 4.3 inch color LCD • Touch button	PACP5 A000 ACP 5 • BMS Integration (BACnet IP, Modbus TCP)		PACP5 A000 ACP 5 • BMS Integration (BACnet IP, Modbus TCP)	PAHCM S000 AHU Comm.Kit • Discharge air

Academic Institution Control Solution

Class Room
Automatically save energy in the absence of students
Central controls prevent students from arbitrary control

Lecture Hall
Schedule management according to academic plan

Maintenance Office
Integrated management of distributed buildings
Centralized management with multiple interfaces

Design Proposal

CLASS ROOM	LECTURE HALL	MAINTENANCE OFFICE	
Automatically save energy in the absence of students	Central controls prevent students from arbitrary control	Integrated management of distributed buildings	Centralized management with multiple interfaces
PTVSM A0 Human detection sensor	PACP5 A000 ACP 5 • BMS Integration (BACnet IP, Modbus TCP)	PACM5 A000 AC Manager 5	PACM5 A000 AC Manager 5
PREMTB100 Wired remote controller • 4.3 inch color LCD • Touch button	PACSS A000 AC Smart 5 • BMS Integration (BACnet IP, Modbus TCP)		

Office Control Solution

Maintenance Office
Energy savings and management throughout the building

Integrated management of HVAC with BMS system

Reduce costs by replacing BMS

Office Room
Reasonable power distribution to tenants

Server Room
24-hour backup management

Meeting Room
Energy savings based on occupancy detection

Residential Control Solution

Home
Anytime, anywhere air conditioner control and access

Integrate systems for smart connectivity throughout

Bed Room
Use a familiar residential thermostat

Simple interlocking control by remote control

Apartment / Residence
Stable system operation

Design Proposal

MAINTENANCE OFFICE	OFFICE ROOM	SERVER ROOM	MEETING ROOM
Energy savings and management throughout the building	Reasonable power distribution to tenants	Main equipment 24 hours back up management	Energy savings based on occupancy detection
 Target Forecasting	 WHM (Watt-Hour Meter) Pulse signal Power 100 kWh PDI	 Error A B 24 HOURS	 Human detection sensor
Integrated management of HVAC with BMS system BMS Protocol BMS System 	Reduce costs by replacing BMS Pump Lighting Fan Sensor	 AC Smart 5	 Human detection sensor
PAC55A000 AC Smart 5 • BMS Integration (BACnet IP, Modbus TCP)	PPWRDB000 PDI Standard (2 ports) • Max. 128 IDU	PAC55A000 AC Smart 5 • BMS Integration (BACnet IP, Modbus TCP)	PTV5MA0 Human detection sensor
PAC5A000 ACP 5 • BMS Integration (BACnet IP, Modbus TCP)	PQNUD1S40 PDI Premium (8 ports) • Max. 128 IDU	PAC5A000 ACP 5 • BMS Integration (BACnet IP, Modbus TCP)	PREMTB100 Wired remote controller • 4.3 inch color LCD • Touch button
PLNWKB000 LonWorks gateway	PEXPMB000 ACS IO Module	PMBUSB00A Modbus RTU gateway	PREMTB100 Wired remote controller • 4.3 inch color LCD • Touch button
PEXPMB000 ACS IO Module	PEXPMB000 ACS IO Module	PEXPMB000 ACS IO Module	PREMTB100 Wired remote controller • 4.3 inch color LCD • Touch button
PEXPMB000 ACS IO Module	PEXPMB000 ACS IO Module	PEXPMB000 ACS IO Module	PREMTB100 Wired remote controller • 4.3 inch color LCD • Touch button

Design Proposal

HOME	BED ROOM	APARTMENT
Control your home air conditioner anytime, anywhere	Use a familiar residential thermostat	Stable system operation when indoor unit power is lost
 Build a Smart house	 Simple interlocking control by remote control	 Independent power module
 Wi-Fi modem	 Wired remote controller	 Independent power module
PWFMD200 Wi-Fi modem	PDRYCB320 8 contact point	PRIP0 Independent power module • EEV full close function
Function • On / Off • Fan speed • Operation mode • Vane control • Reservation (Sleep, Weekly On / Off) • Error check	Function • Operation • Indoor temperature • Error alarm • Set operation mode • Set temperature • Set fan speed	Input • Universal Input • Operation On / Off • Thermo On / Off • Operation mode (Fan / Heat / Cool) • Fan speed (Low / Middle / High)
Output • Operation On / Off status • Error alarm	Input • 4.3 inch color LCD • Touch button	Output • Operation On / Off status • Error alarm

318 - 339

ACCESSORIES

MECHANICAL ACCESSORIES / PIPING ACCESSORIES

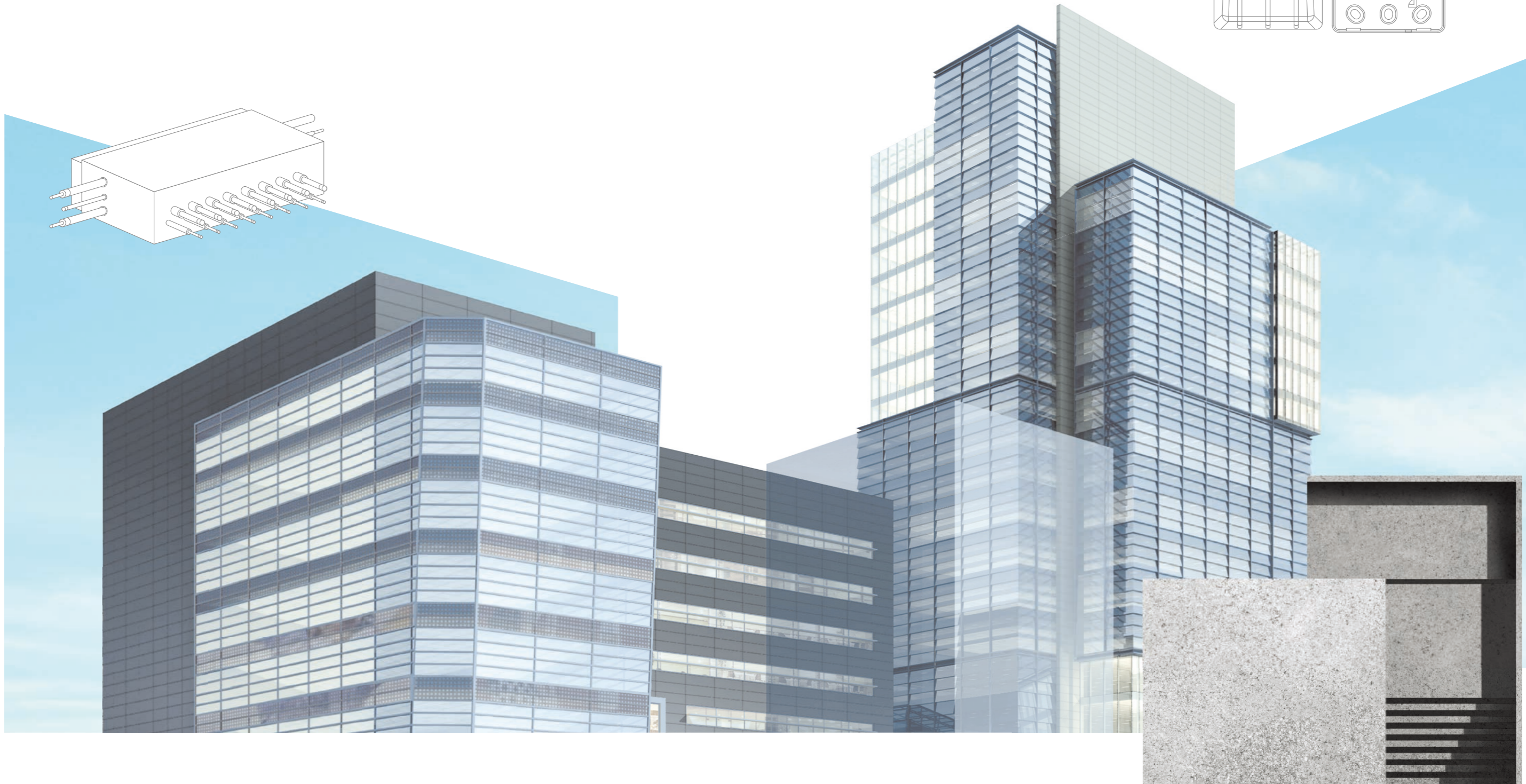
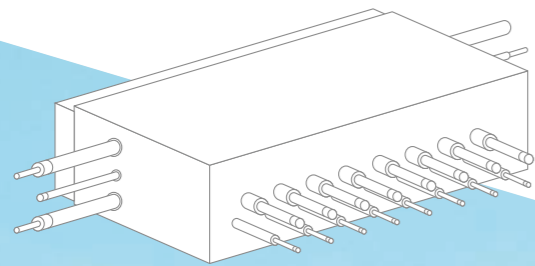
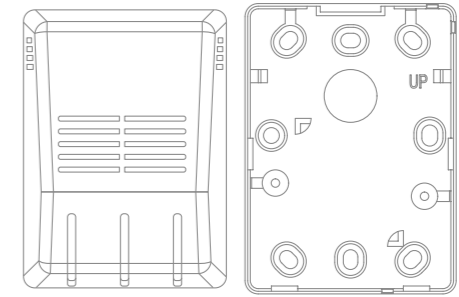

Cassette Panel

The Independent Vane Operation makes desired and comfortable air flow.



Model Name & Applied Products

4 Way Cassette (Mini, 570x570)

PT-QAGWO
PT-QCHWO
PT-UQC

2 Way Cassette

PT-USC

1 Way Cassette (Grill Type)

PT-UAHGO / PT-TAHGO (Glossy)
PT-UAHWO / PT-TAHWO (Non-Glossy)
PT-UPHGO / PT-TPHGO (Glossy)

1 Way Cassette (Air Purification)

PT-UPHGO / PT-TPHGO

Key Features

- Independent vane operation uses separate motors, making it possible to control all 1, 2, and 4 vanes independently.
- The detachable corner design makes it easy to adjust the hanger during installation and to check for leakages in the drain pipe and refrigerant pipes.

Compact and Stylish Design

- New 4 way cassette panel adapted unibody shape and matching with into the ceiling.
- Panel size is fit into the ceiling tile.

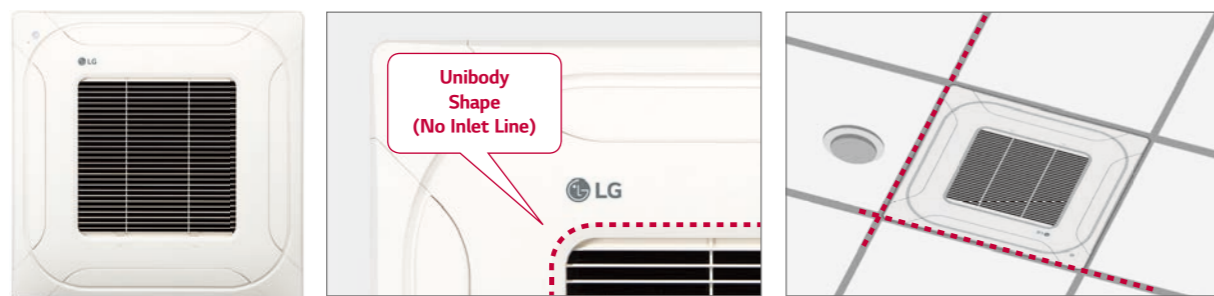

Specification

Model	Suction Type	Color (RAL)	Gloss	Weight (kg)	Dimension (mm)			Applied Model Capacity (kW)*						
					W	H	D	Single Split		Multi Split		Multi V		
								R32	R410A	R32	R410A	R32	R410A	
4 Way	PT-QCHWO	Grill	Morning Fog (RAL 9001)	X	3.0	620	35	620	2.5-5.0	2.5-5.0	1.5-5.3	1.5-5.3	1.6-6.2	1.6-6.2
	PT-UQC	Grill	Morning Fog (RAL 9001)	X	3.0	700	22	700	2.5-5.0	2.5-5.0	1.5-5.3	1.5-5.3	1.6-6.2	1.6-6.2
	PT-QAGWO	Grid	White (RAL 9003)	X	2.9	620	35	620	2.5-5.0	2.5-5.0	1.5-5.3	1.5-5.3	1.6-6.2	1.6-6.2
2 Way	PT-USC	Grill	Morning Fog (RAL 9001)	X	4.7	1,100	28	690					2.8-7.1	2.8-7.1
1 Way	PT-UAHGO	Grill	White (RAL 9003)	O	3.9	1,160	34	500			2.6-3.5	2.6-3.5	2.2-3.6	2.2-3.6
	PT-TAHGO	Grill	White (RAL 9003)	O	4.8	1,480	34	500			2.6-3.5	2.6-3.5	5.6-7.1	5.6-7.1
	PT-UAHWO	Grill	White (RAL 9003)	X	3.3	1,100	34	500			2.6-3.5	2.6-3.5	2.2-3.6	2.2-3.6
	PT-TAHWO	Grill	White (RAL 9003)	X	4.5	1,420	34	500			2.6-3.5	2.6-3.5	5.6-7.1	5.6-7.1
	PT-UPHGO	Grill	White (RAL 9003)	O	4.1	1,160	34	500			2.6-3.5	2.6-3.5	2.2-3.6	2.2-3.6
	PT-TPHGO	Grill	White (RAL 9003)	O	4.9	1,480	34	500			2.6-3.5	2.6-3.5	5.6-7.1	5.6-7.1

* Based on cooling capacity
※ O : Applied, - : Not applied

Dual Vane Cassette Panel



Model Name

PT-AAGWO
PT-AFGWO

Key Features

Model	Function					
	Dual Vane	Wi-Fi	Floor Temperature Sensor	Air Purification	Elevating Grille	Human Detection Sensor
PT-AAGWO	O	Optional	Optional	X	X	Optional
PT-AFGWO	O	Optional	Optional	Optional (Dust Sensor, Tact Switch)	X	Optional

Specification

Model	Suction Type	Color (RAL)	Gloss	Weight (kg)	Dimension (mm)		
					W	H	D
PT-AAGWO	Grid	White (RAL 9003)	-	7.1	950	35	950
PT-AFGWO	Grid	White (RAL 9003)	-	7.5	950	35	950

Air Purification Kit

Model	Image	Model name	Dielectric Dust collecting filter	Photocatalytic Deodorizing filter	HVPS	Ionizer
Air cleaning kit		PTAHMPO	O	O	O	O
		PTAHTPO	O	O	O	O

Cassette Cover

Cover in case of exposed cassette installation.

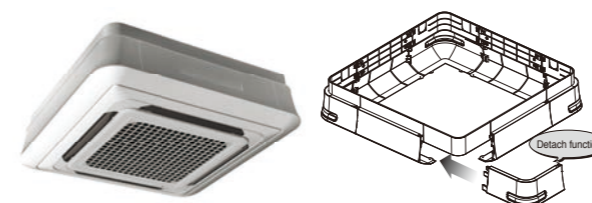

Model Name

PTDCM / PTDCQ

Applied Products

4 Way Cassette (for chassis TA, TB, TQ, TR)

Included Parts

- Cover A, Cover B
- Cover C, Cover D
- Screws
- Installation Manual

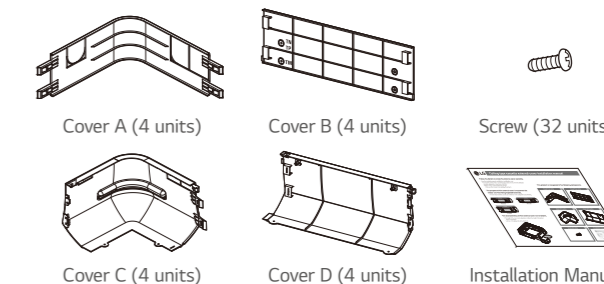

Key Features

- Specially designed for indoor unit
- Covers the side area of cassette
- Gives elegant looks
- Light weight

Specification

Model	Front Panel		Weight (kg)		Dimensions (mm)		
			NET	Gross	W	H	D
PTDCM	PT-AAGWO / PT-AFGWO	TB	5.9	8.8	1,157	1,157	268
		TA	5.9	8.8	1,157	1,157	310
PTDCQ	PT-UQC	TR	5.0	7.2	907	907	268
		TQ	5.0	7.2	907	907	310

CO₂ Sensor

CO₂ sensor in ventilation system.



Model Name
AHCS100H0

Applied Products
LZ-H025GBA4
LZ-H035GBA5 / LZ-H050GBA5
LZ-H080GBA5 / LZ-H100GBA5
LZ-H150GBA5 / LZ-H200GBA5

Applicable Products
LZ-H050GXN0 / LZ-H080GXN0
LZ-H100GXN0 / LZ-H050GXH0
LZ-H080GXH0 / LZ-H100GXH0

Key Features

- Specification
- Applied Model : ERV (Embedded), ERV DX (Option)
 - Supply voltage : DV12V ± 5%
 - Output : 0.6 ~ 4.4V (Linear output, 240 ~ 1,760 ppm CO₂)
 - Accuracy : ± 10% (2 days after installation)

Description

- The product is especially designed to detect CO₂.
- This model requires Standard III Wired Remote Controller for display.

Key Application

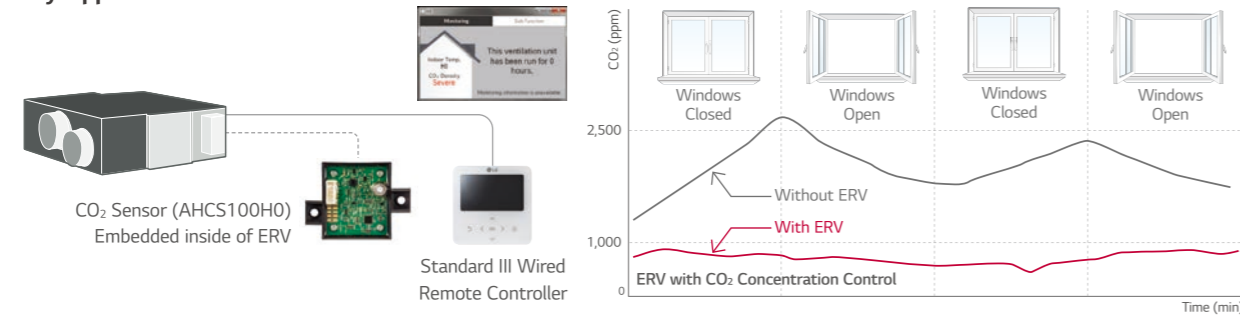

How to Install

1. Remove a screw on the service cover. Pull the service cover fixing bracket (1), then remove the service cover (2). Remove two elements (3) and two air filters (4).
 2. Install the sensor with two screws.
 3. Remove a screw, then remove the right side of element rail (5).
 4. Press the holder (6) into the hole to fix the CO₂ sensor cable (7).
 5. Connect the wire terminal to the CN-CO₂ port of PCB.
- ※ Airflow can be controlled by concentration of CO₂, after setting automatic operation mode at remote controller.
※ Use the screwdriver whose total length is less than 250mm.

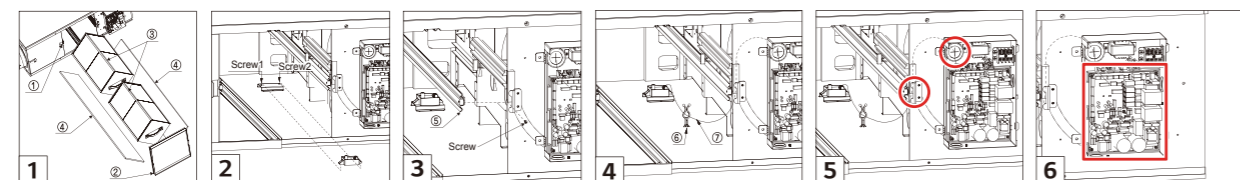

Dimensions (Unit : mm)

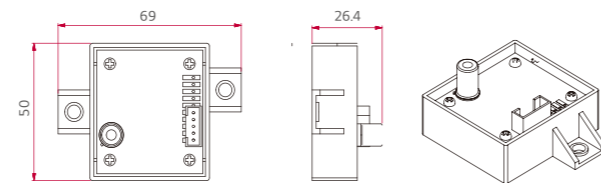

Refrigerant Leakage Detector

R410A refrigerant leakage detector ensures room safety.



Model Name
PRLDNVSO

Applied Products
Multi V 5
Multi V IV Heat Pump & Heat Recovery
Multi V Water IV

Key Features

- This detector senses refrigerant leakage when the refrigerant concentration exceeds 6,000ppm. (The green and red LED lights blink simultaneously)
- Alarm is "on" when refrigerant leaks out more than 6,000ppm for 5 seconds. If it is reduced less than 6,000ppm for 5 seconds, alarm is "off".
- When the alarm of the refrigerant leak detector is switched on the user must ventilate the room until the alarm is disabled.
- The detector has to be installed inside the room and it should be installed 300 ~ 500mm above the floor.

Specification

Parts	Specification	
Sensor	Rated Voltage (V)	DC 5.0 ± 5%
	Dimensions (W x H x D, mm)	31 x 44 x 20
	Weight (g)	22
	Detectable Refrigerant	R410A
	Detected concentration (ppm)	0 / 6,000 Alarm Off / On
	Operating temperature range (oC)	-10 ~ 50
	Preserved temperature range (oC)	-40 ~ 60
Connecting cable	Average power consumption (mA)	35
	Cable length (m)	10
Sensor protective cover	Dimensions of Front Plate (W x H x D, mm)	80 x 110 x 44.6
	Dimension of Backplate (W x H x D, mm)	80 x 110 x 6.5

This function available for ARU****L**5 and 4 (MULTI V 5, MULTI V IV H/P, H/R model)

Included Parts

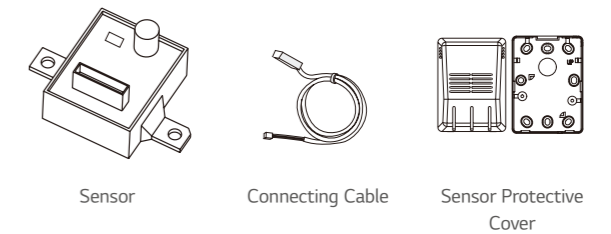

Key Application

Refrigerant Leakage Detector has three application methods.

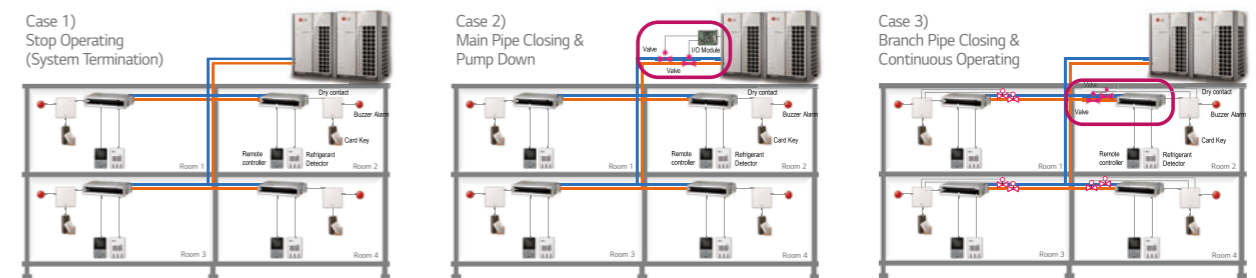

Accessory Specification (To realize the case 2 application)

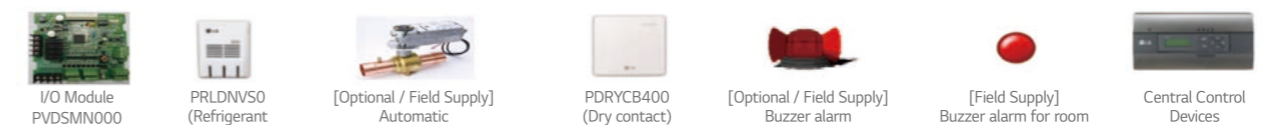

※ Necessary accessory

1) Please contact to subsidiary to get the recommended specification. (LG Electronic don't provide this accessory)

EEV KIT (for Indoor Unit)

MULTI V EEV KIT is specially designed to reduce noise and make comfort environment.



Model Name
PRGK024A0

Key Features

- Decreasing noise level of Multi V Indoor units and easy installation.

Key Application

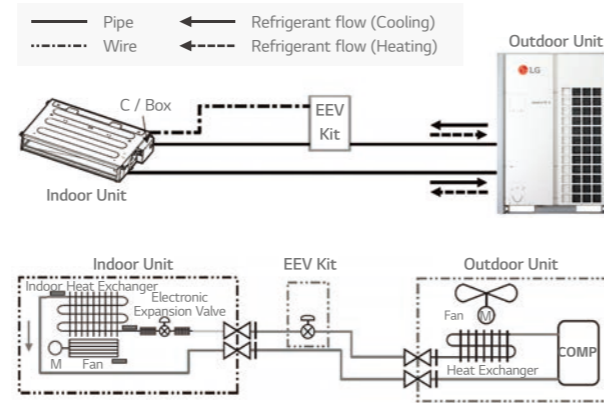

Applied Products

Indoor Unit	Model	Chassis	Applicable
Cassette	1 Way Cassette	TU	○
	2 Way Cassette	TT	N/A
		TS	○ (~5.6kW)
	4 Way Cassette	TR	○
		TQ	○ (~4.5kW)
		TP	N/A
TN		N/A	
Duct	High Sensible	BG	-
		BR	-
		B8	-
	High Static	B8	-
		M1	○ (~5.6kW)
	Middle Static	M2	-
		M3	-
		L1	○
	Low Static	L2	-
L3		-	
L3		-	
Etc	Floor Standing	CE	○
	Convertible	CF	-
		VE	○
	Ceiling Suspended	V1	-
		V2	-
	Wall Mounted	SJ	○
		SK	○
	SV	-	
	Art Cool	SF	○
	Console	QA	○
Hydro kit	K2	-	
	K3	-	

※ ○ : Applied, - : Not applied, N/A : Not Applicable

EEV Kit can be applied for the space which requires quiet environment and noise sensitive space.



Note : If you don't use EEV of same specification, Cooling (Heating) capacity could be decreased.

How to Install

Open Indoor unit's control box cover.

- ① Open fully indoor unit's EEV through vacuum mode of ODU setting.
- ② Detach the Indoor unit's EEV connector from PCB and then push the reset button of Outdoor unit's PCB.
- ③ After connecting indoor unit's EEV CONNECTOR, repeat the process ① & ②. Then, connect the EEV CONNECTOR of EEV KIT in PCB of indoor unit.
- ④ Finally connect the lead wire of the EEV Kit to the indoor unit's PCB.
- ⑤ Assemble the control box cover.

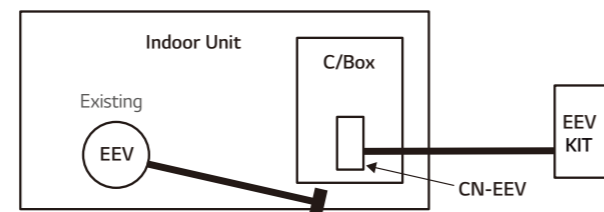

IR Receiver

IR RECEIVER can be connected to ceiling concealed duct and floor standing unit which the customer wants to control by wireless remote controller.



Model Name
PWLRVN000

Applied Products

Multi V Indoors (Ceiling Concealed Duct, Floor Standing Units)

Key Features

- Designed for wireless control
- Indication lamps (3 colors) and Self-diagnosis function

Key Application

Note : Do not install both the IR Receiver and Wired Remote Controller. This may cause malfunctions.

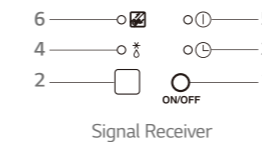
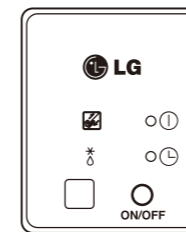

Operation of Indication Lamps

- ① Emergency Operation button : Turns the indoor unit on or off when remote controller is not working.
- ② Signal Detector : Receives the signal from remote controller.
- ③ Timer lamp (Green) : Lights up during the timer operation.
- ④ Hotstart lamp (Orange) : Lights up during the pre-heating operation, defrost operation as well as latent heat removal operation in heat mode. Available only for the heat pump models, not cooling only models.
- ⑤ System On / Off lamp (Red) : Lights up during system controller operation.
- ⑥ Filter Sign lamp (Green) : Lights up after 2,400 hours from the time of first power on operation.

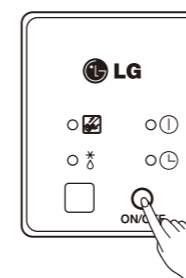

Test Run Mode

After installing the product, you must run a Test Run mode. Press the Emergency Operation button for 5 seconds, until the LED flickers. Then the indoor unit, duct runs cooling mode for 18 minutes, where the setting temperature is 18°C and the fan speed is high.

Independent Power Module

It closes EEV in indoor there is a power cut.



Model Name
PRIPO

Applied Products
Multi V Indoor Units

Key Features

- Independent Power Module is specially designed to close the Indoor EEV when power cut-off.
- Supply Voltage : DC 12V ± 50%

Included Parts

Model	PRIPO			
Item	Independent Power Kit	Screw	Clamp (Tie Wrap)	(Other)
Q'ty	1	2	4	<ul style="list-style-type: none"> Harness 1 (1 m) Harness 2 (1 m) Harness 3 (1 m) Harness 4 (0.05 m) Installation Manual Insulator (PE, 2 EA)
Figure				

Key Application

If the EEV is opened due to power cut off, liquid refrigerant flows into compressor. It could damage the compressor in cooling mode. Also condensing might be happened for unclosed EEV's indoor unit due to flow of refrigerant.

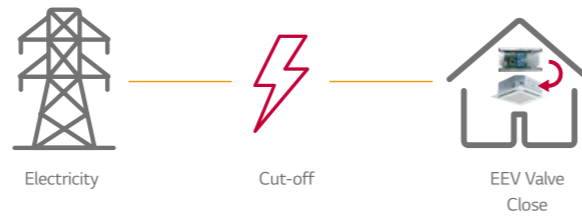

How to Install

- Turn the power off using circuit breaker.
- Disconnect the EEV cable of the indoor unit's PCB.(CN-EEV)
- Connect the independent power kit (CN-EEV/LOAD) to the indoor unit's EEV, using harness 1.
- Connect the independent power kit (CN-EEV/MAIN) to the indoor unit's PCB (CNEEV/CN_WRITE or CN1 or CN1_IPM), using harness 2 or 3, 4.
- Supply the power.

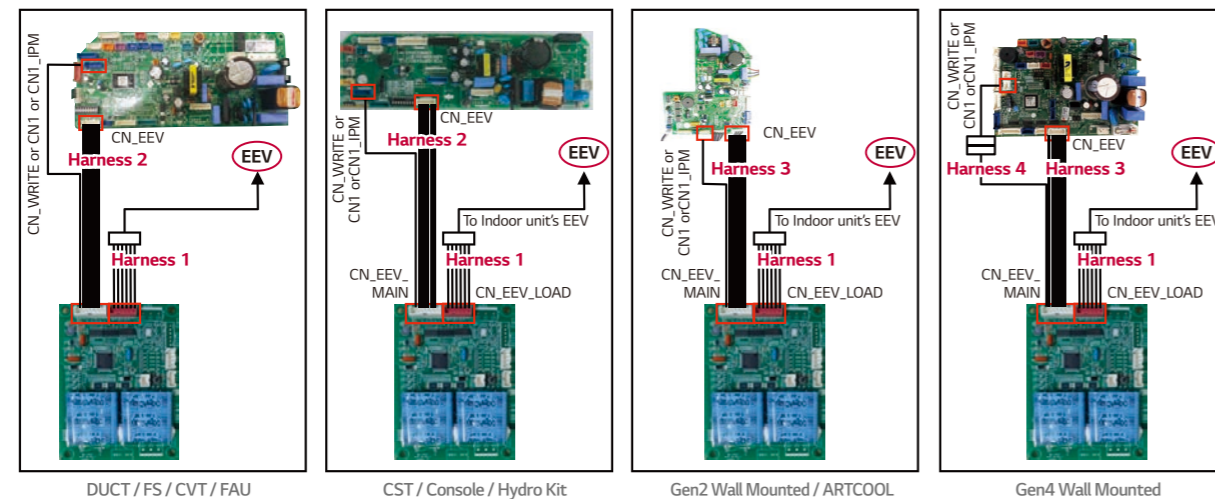

* FS : Floor Standing
* CVT : Convertible
* FAU : Fresh Air Intake Unit
* CST : Cassette

Auxiliary Heater Relay Kit

Providing an efficient way to add auxiliary heat.



Model Name
PRARS1

Applied Products
Wall Mounted, Art Cool Mirror, Art Cool Gallery

Model Name
PRARH1

Applied Products
1, 2, 4 Way Ceiling Cassette, High Static Ducted, Low Static Ducted, Ceiling Suspended

Key Features

- Provides two stages of auxiliary heat for indoor unit.
- Provides ability to use the two stage auxiliary heater as the primary or secondary heating source.

Included Parts

Model	PRARH1			
Item	Auxiliary Heater Relay Kit	Screw	Insulation	Installation Manual
Q'ty	1	2	2	1
Figure				

Model	PRARS1			
Item	Auxiliary Heater Relay Kit	Screw	Insulation	Installation Manual
Q'ty	1	2	2	1
Figure				

Key Application

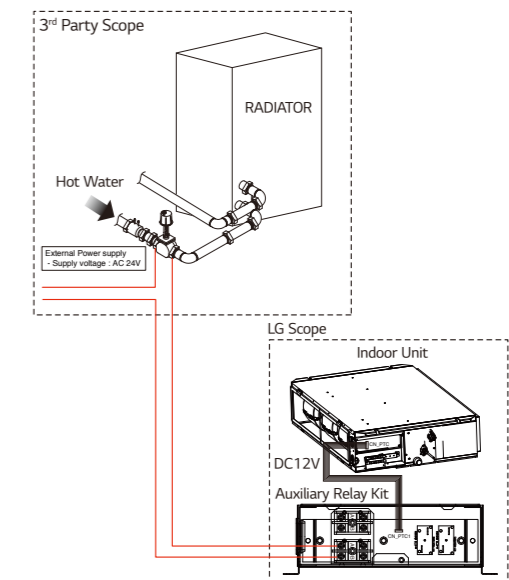

How to Install

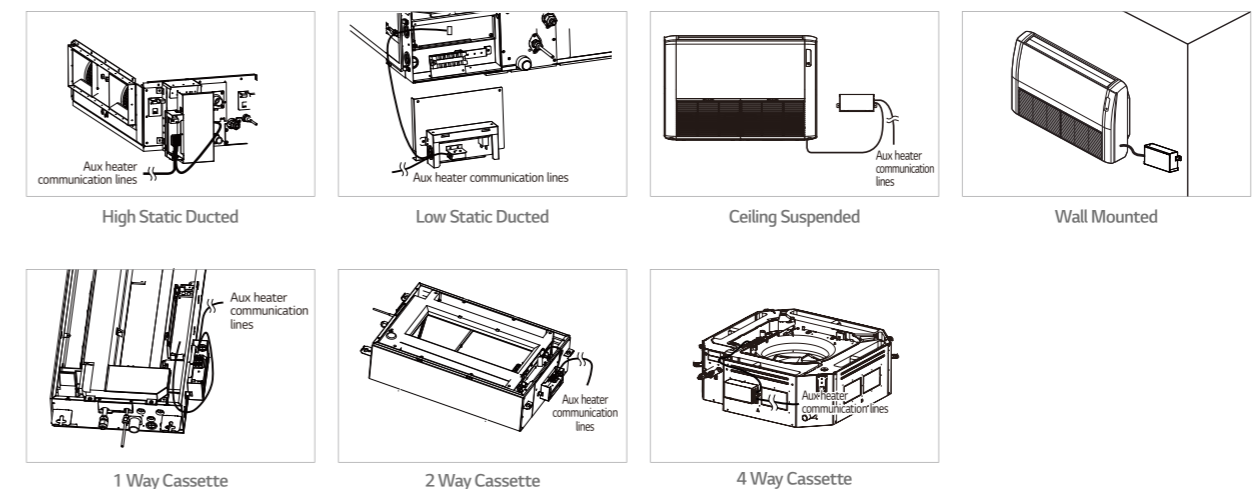

Heat Recovery

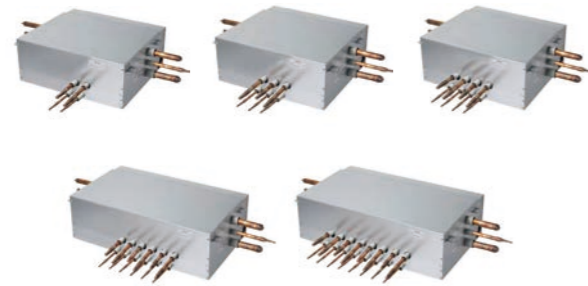

Model Name

- PRHR023 (2 Branch Unit)
- PRHR033 (3 Branch Unit)
- PRHR043 (4 Branch Unit)
- PRHR063 (6 Branch Unit)
- PRHR083 (8 Branch Unit)

Applied Products

- Multi V 5
- Multi V IV
- Multi V Water IV

Key Features

- Max. 64 indoor units can be connected. (Max. 8 indoor units per branch)
- It is easy to install due to the automatic search algorithm for piping detection.
- Subcooling cycle in HR unit makes the system efficiency maximum.

Connection Capacity

Maximum number of connectable indoor units :
64 IDUs / HR unit (in case of 8 ports model)

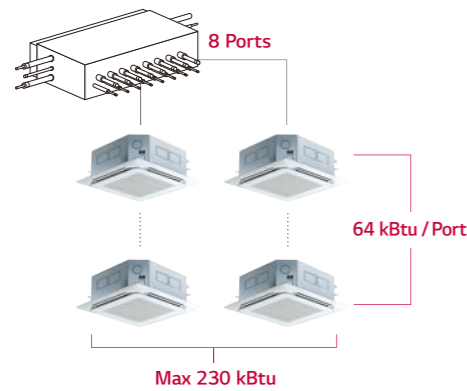

Flexible Connection

Series connection can be installed without pipes crossing.

New

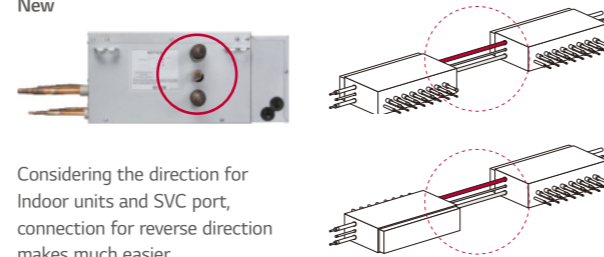

Considering the direction for Indoor units and SVC port, connection for reverse direction makes much easier

Reduce Noise

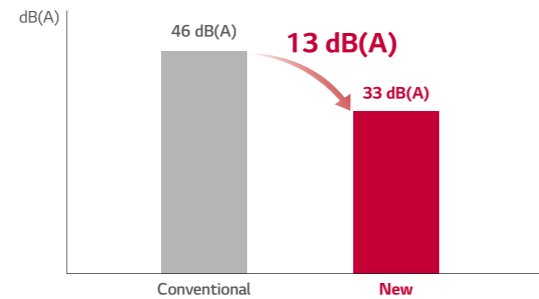

Test Condition (ISO Standard)
 - Temp. : (Cooling) 27°C DB / 19°C WB, 35°C DB / 24°C WB
 (Heating) 20°C DB / 15°C WB, 7°C DB / 6°C WB
 - Operating : cooling → heating switching operation

Included Parts

- HR unit (1EA)
- Hanging bolts M10 or M8 (4EA)
- Nut M8 or M10 (8EA)
- Washers M10 (8EA)
- Reducers

Specification

Model		PRHR023	PRHR033	PRHR043	PRHR063	PRHR083		
Number of Branch	EA	2	3	4	6	8		
Maximum Connectable Capacity of Indoor Units (Per branch / unit)	kW	17.5 / 35	17.5 / 52.5	17.5 / 69.5	17.5 / 69.5	17.5 / 69.5		
Maximum Number of Connectable Indoor Units Per Branch	EA	8	8	8	8	8		
Nominal Input	Cooling	kW	0.040	0.040	0.040	0.076	0.076	
	Heating	kW	0.038	0.038	0.038	0.072	0.072	
Net. Weight	kg	18.5	20.3	22.0	28.3	31.8		
Dimensions (W x H x D)	mm	786 x 218 x 657	786 x 218 x 657	786 x 218 x 657	1,113 x 218 x 657	1,113 x 218 x 657		
Piping Connections	Indoor Unit	Liquid	mm (inch)	9.52 (3/8)	9.52 (3/8)	9.52 (3/8)	9.52 (3/8)	9.52 (3/8)
		Gas	mm (inch)	15.88 (5/8)	15.88 (5/8)	15.88 (5/8)	15.88 (5/8)	15.88 (5/8)
	Outdoor Unit	Liquid	mm (inch)	9.52 (3/8)	12.7 (1/2)	15.88 (5/8)	15.88 (5/8)	15.88 (5/8)
		Low Pressure	mm (inch)	22.2 (7/8)	28.58 (11/8)	28.58 (11/8)	28.58 (11/8)	28.58 (11/8)
		High Pressure	mm (inch)	19.05 (3/4)	22.2 (7/8)	22.2 (7/8)	22.2 (7/8)	22.2 (7/8)
		Power Supply	Ø, V, Hz	1, 220-240, 50 1, 220, 60	1, 220-240, 50 1, 220, 60	1, 220-240, 50 1, 220, 60	1, 220-240, 50 1, 220, 60	1, 220-240, 50 1, 220, 60

Reducers for Indoor Unit and HR Unit

(Unit : mm)

Model	Liquid	High Pressure	Low Pressure
Indoor unit reducer			
PRHR023			
HR unit reducer			
PRHR033 PRHR043 PRHR063 PRHR083			

Y Branch and Header Branch

For refrigerant distribution of indoor units.



Model Name
Refer to specifications

Applied Products
Multi V S
Multi V IV
Multi V III, Multi V Plus II, Multi V Plus
Multi V S
Multi V Water IV
Multi V Water II
Multi V Water S

- Key Features**
- Various Y Branch pipe of different capacities make MULTI V installation much easier.
 - Y Branch and header branch for both gas and liquid are provided.
 - Insulation material is also provided for covering the branches.

Key Application

Heat Pump System

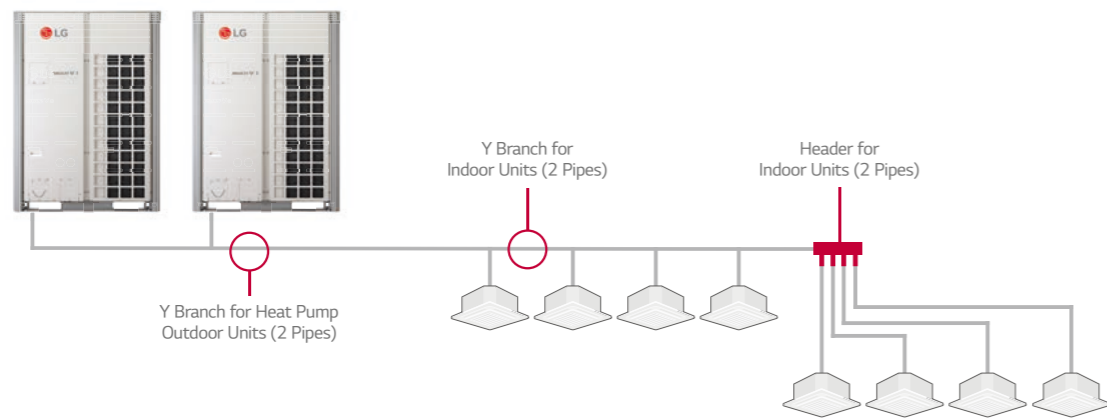

Heat Recovery System

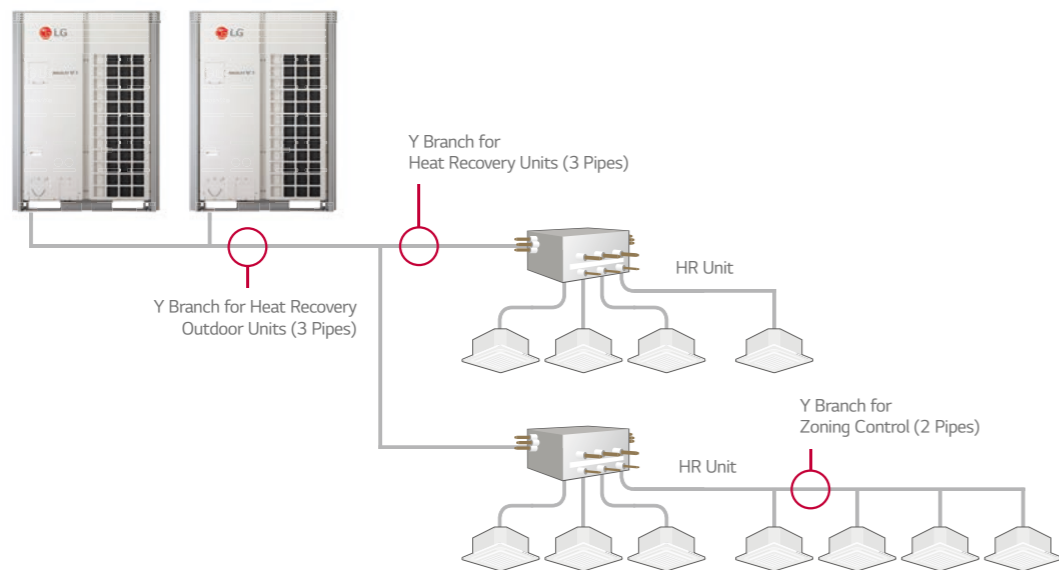

Specification

Header Branch

R410A

(Unit : mm)

Model	Gas Pipe	Liquid Pipe
ARBL054 (4 Branch)		
ARBL057 (7 Branch)		
ARBL104 (4 Branch)		
ARBL107 (7 Branch)		
ARBL1010 (10 Branch)		
ARBL2010 (10 Branch)		

Piping Accessories

Y Branch pipe for connection of outdoor units.

Specification

Heat Pump

R410A MULTI V 5, MULTI V IV, MULTI V III, MULTI V WATER IV, MULTI V WATER II

(Unit : mm)

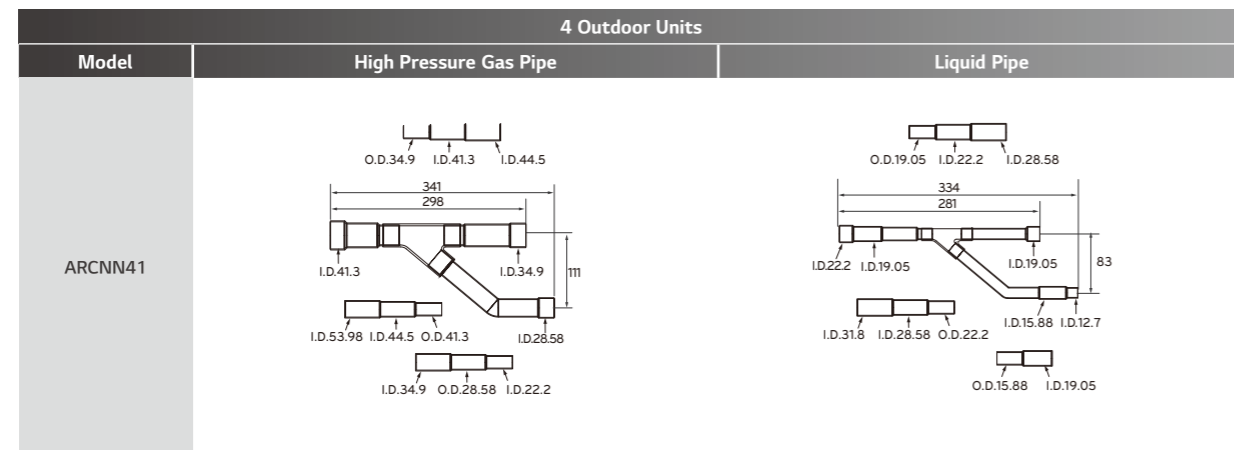
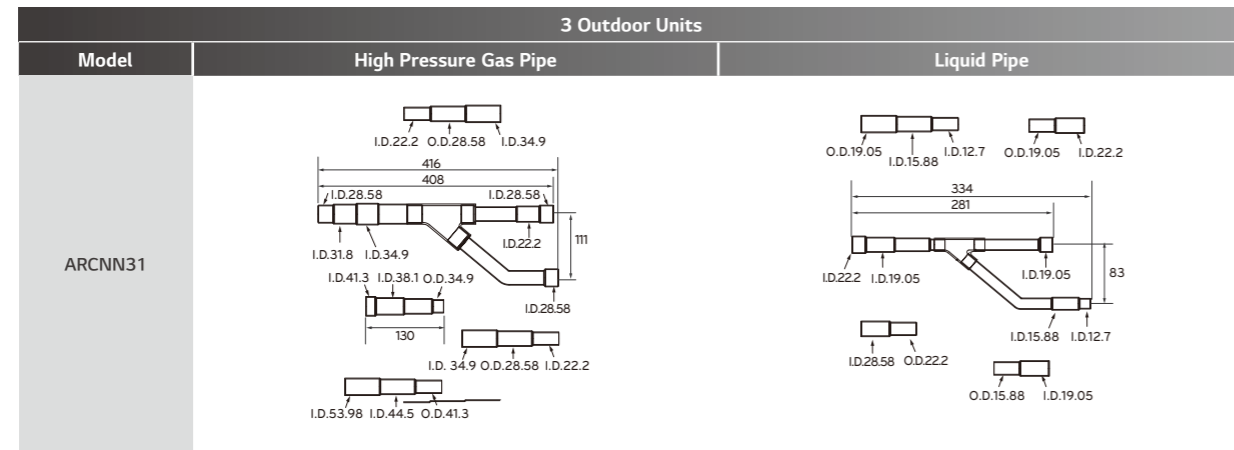
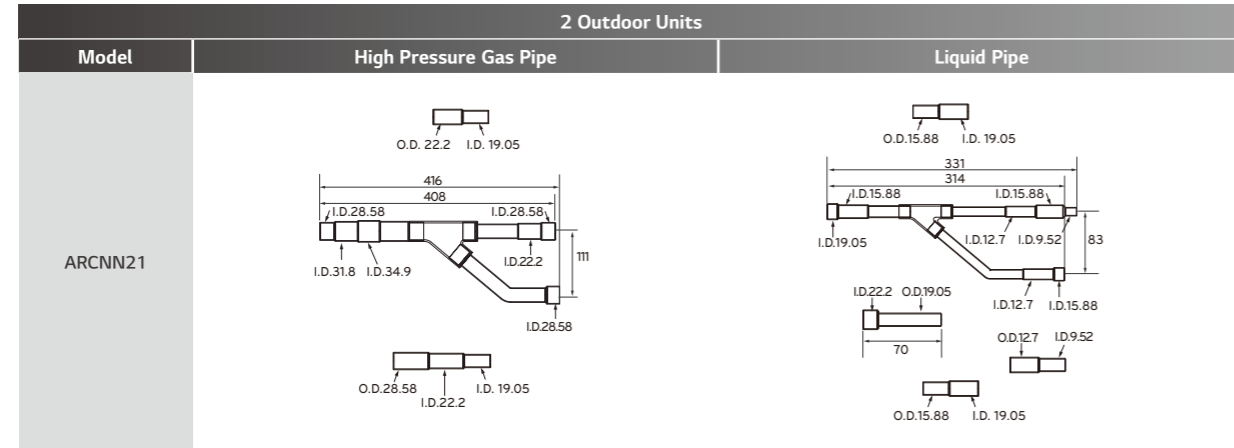

Specification

Heat Recovery

R410A MULTI V 5, MULTI V IV Heat Recovery, MULTI V III Heat Recovery, MULTI V WATER IV Heat Recovery, MULTI V WATER II Heat Recovery

(Unit : mm)

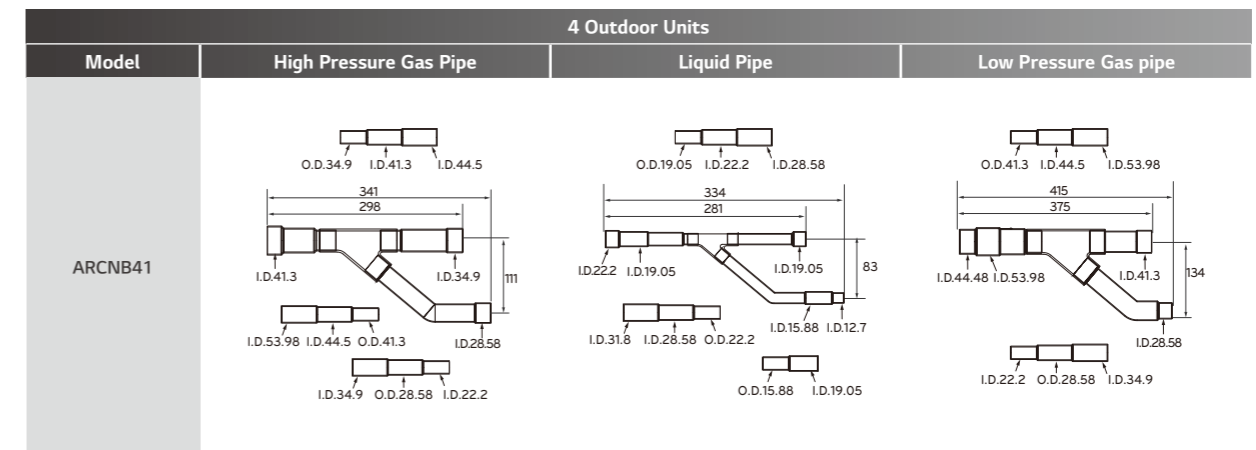
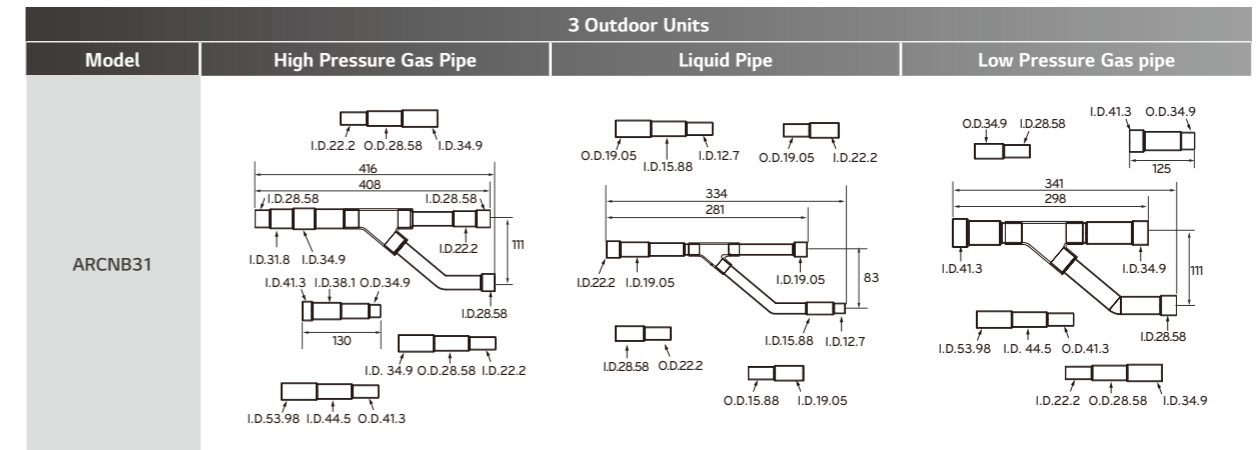
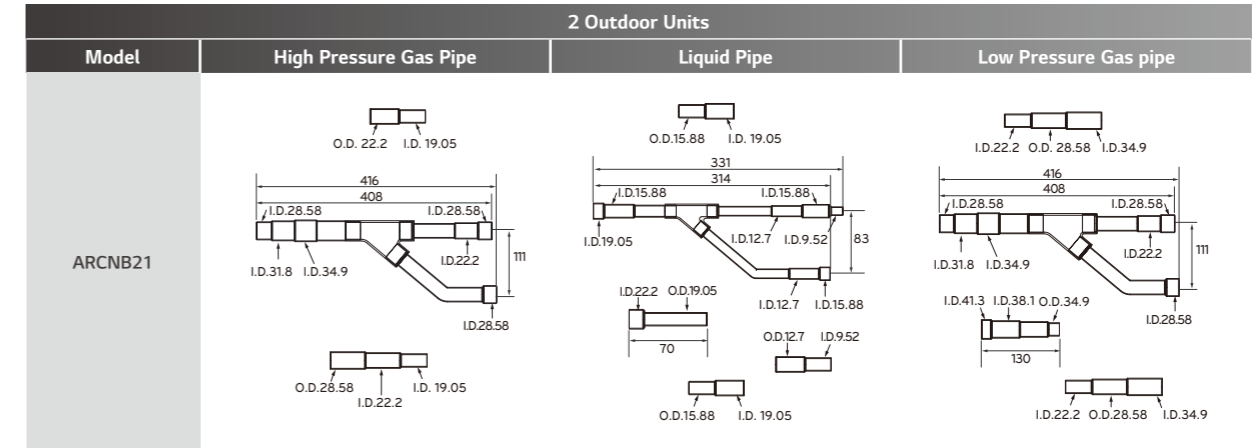

Piping Accessories

Y Branch pipe for connection of outdoor units.

Specification

Heat Pump, Heat Recovery Zone Control

R410A MULTI V 5, MULTI V IV, MULTI V III, MULTI V PLUS II, MULTI V PLUS, MULTI V S, MULTI V MINI, MULTI V SPACE II, MULTI V WATER IV, MULTI V WATER S, MULTI V WATER II

(Unit : mm)

Model	Gas Pipe	Liquid Pipe
ARBLN01621		
ARBLN03321		
ARBLN07121		
ARBLN14521		
ARBLN23220		

Specification

Heat Recovery

R410A MULTI V 5, MULTI V IV Heat Recovery, MULTI V III Heat Recovery, MULTI V WATER IV Heat Recovery, MULTI V WATER II Heat Recovery

(Unit : mm)

Model	High Pressure Gas Pipe	Liquid Pipe	Low Pressure Gas Pipe
ARBLB01621			
ARBLB03321			
ARBLB07121			
ARBLB14521			
ARBLB23220			

Refrigerant Charging Kit

Recharging refrigerant after a pump down or when refrigerant is either insufficient or excessive.

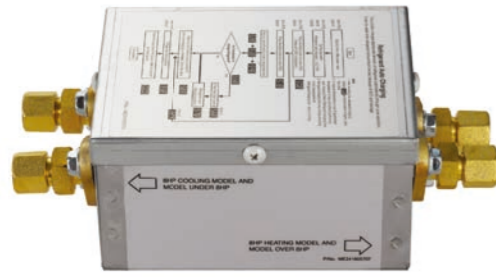

Model Name
PRAC1

Applied Products

- MULTI V 5
- MULTI V IV Heat Pump
- MULTI V IV Heat Recovery
- MULTI V III Heat Pump
- MULTI V III Heat Recovery
- MULTI V PLUS II
- MULTI V SYNC II

How to Use

- Arrange manifold, capillary assembly, refrigerant vessel and scale.
- Connect manifold to the gas pipe service valve of outdoor unit as shown in the figure.
- Connect manifold and capillary tube. Use designated capillary assembly only. If designated capillary assembly isn't used, the system may get damaged.
- Connect capillary and refrigerant vessel
- Purge hose and manifold
- After "568" is displayed, open the valve and charge the refrigerant.

Key Application

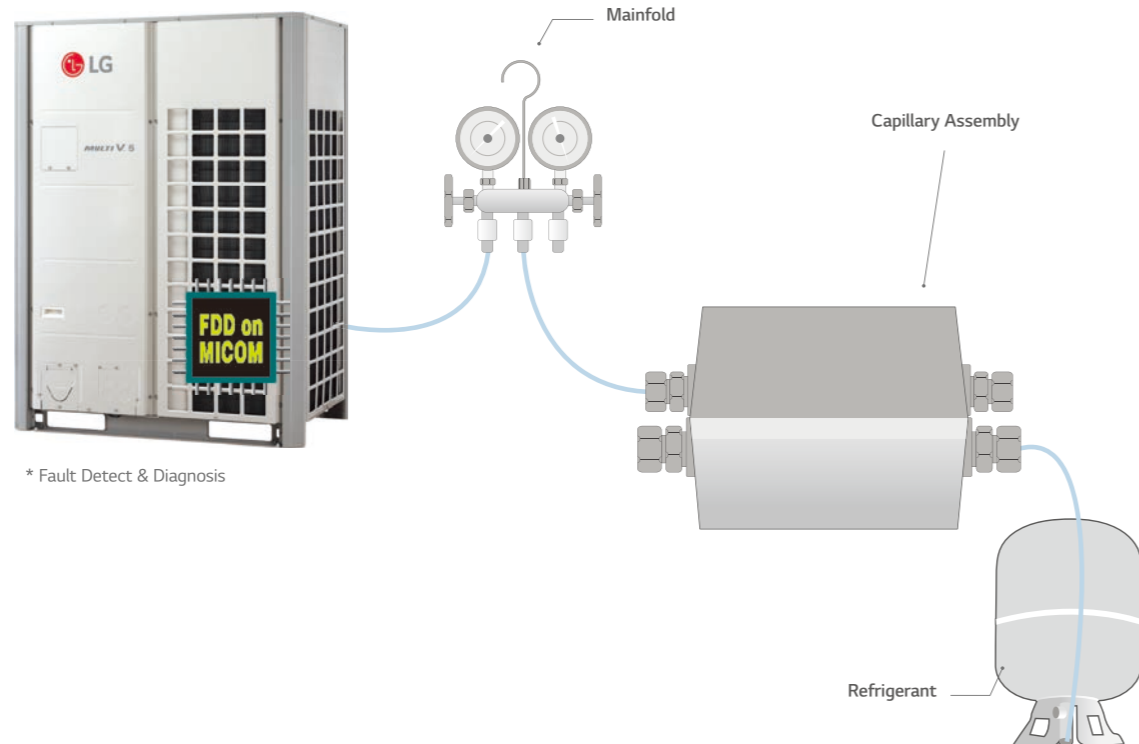

Drain Hose

Easy drain installation.

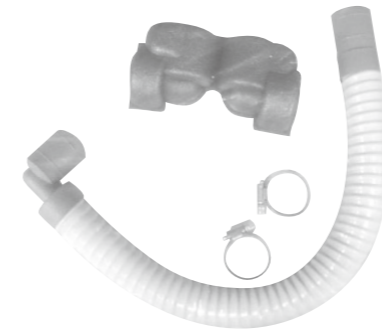

Model Name

- PHDHA05T
- PHDHA07T
- PHDHA05B
- PHDHA07B

Applied Products

Multi V Indoor units

Key Features

- It reduces the installation time by over 40% with elbow-less drain hose.
- Drain pump covers maximum 700mm high, featuring easy piping installation.

Key Application

- Ceiling Mounted Cassette and Ceiling Concealed Duct. (Refer to PDB for applicable model)

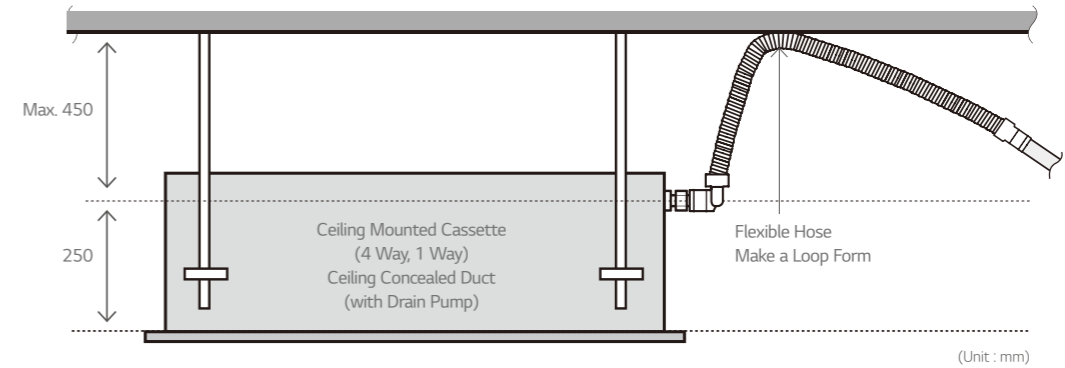

Specification

Model	Length	Quantity
PHDHA05T	500mm	30EA
PHDHA07T	700mm	30EA
PHDHA05B	500mm	5EA
PHDHA07B	700mm	5EA

Stopper Valves



Model Name
 PRVT120 (Under 12.7mm)
 PMVT780 (Under 22.2mm)
 PMVT980 (Under 28.58mm)

Key Features

- This unit can be applied for the additional indoor unit's installation.
- This unit can be applied for each indoor unit's service.

Specification

Model	Specification
PRVT120	
PRVT780	
PRVT980	

How to Install

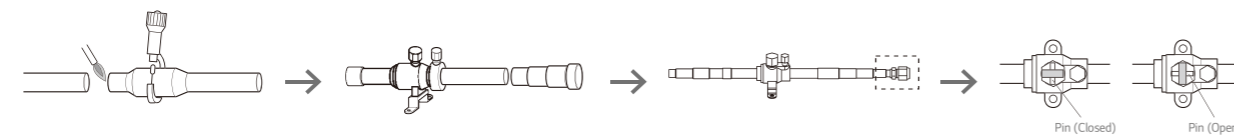

1. Cut the inlet side of the connector, and weld the pipe
2. If installing additional indoor units, the outlet side connector should be cut according to installation pipe.
3. When installing a stopper valve, the flare part should be facing towards additional indoor unit.
4. When installing an additional indoor unit, the SVC valve should be in closed state.

※ When welding, service valve should be wrapped by wet cloth.

Application

(Room 3 & 4 : in use / Room 1 & 2 : need to install indoor units)

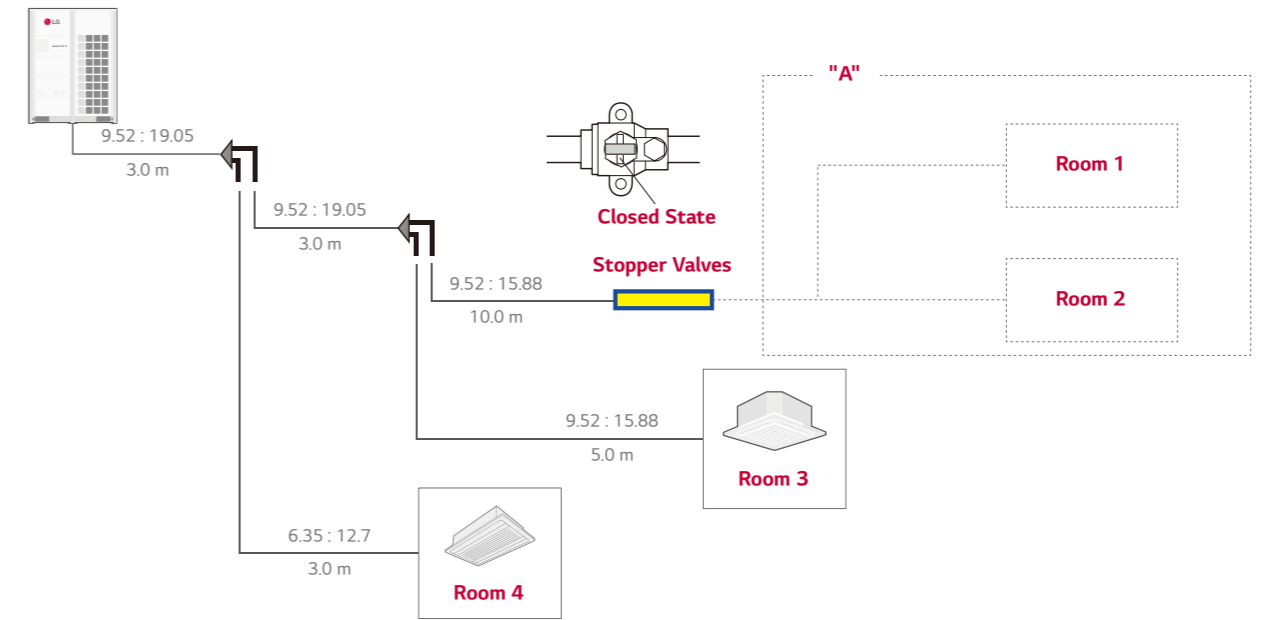

- In case of installation of additional indoor unit, refrigerant of used indoor unit must be discharged. (Room 3 & Room 4)
- If stopper valve is already installed, you can install additional indoor unit without refrigerant loss from the entire system.
- After installation of additional indoor unit, you just need refrigerant charging for "A" section.
- Then, open the Stopper Valve.

